

PRELIMINARY RESULTS OF
THE COMPREHENSIVE
TRAFFIC AND TOLL REVENUE
STUDY FOR THE



DETROIT RIVER INTERNATIONAL CROSSING
PROJECT FORECAST REFRESH AND UPDATE
TRAFFIC-ONLY SUMMARY

Submitted by:

WilburSmith
ASSOCIATES

In association with:

IBI Group
Resource Systems Group, Inc.
The Centre for Spatial Economics



Submitted to:
**Michigan Department
of Transportation**

February 2010

THIS PAGE INTENTIONALLY LEFT BLANK

DISCLAIMER

Current accepted professional practices and procedures were used in the development of these traffic and revenue forecasts. However, as with any forecast of the future, it should be understood that there may well be differences between forecasted and actual results that may be caused by events and circumstances beyond the control of the forecasters. The WSA review and analysis has relied upon the accuracy and completeness of all of the information provided (both written and oral) by Michigan Department of Transportation and several local and state agencies. Publicly available and obtained material has neither been independently verified, nor does WSA assume responsibility for verifying, such information and has relied upon the assurances of the independent parties that they are not aware of any facts that would make such information misleading.

WSA has made qualitative judgments related to several key variables within the analysis used to develop the traffic and revenue forecasts that must be considered as a whole; therefore selecting portions of any individual results without consideration of the intent of the whole may create a misleading or incomplete view of the results and the underlying methodologies used to obtain the results. WSA gives no opinion as to the value or merit to partial information extracted from the report.

All estimates and projections reported herein are based on WSA's experience and judgment and on a review of independent third party projections and information obtained from multiple state and local agencies including Michigan Department of Transportation. These estimates and projections may not be indicative of actual or future values, and are therefore subject to substantial uncertainty. Future developments cannot be predicted with certainty, and may affect the estimates or projections expressed in the report, such that WSA does not specifically guarantee or warrant any estimate or projections contained within this report. While WSA believes that some of the projections or other forward-looking statements contained within the report are based on reasonable assumptions as of the date in the report, such forward looking statements involve risks and uncertainties that may cause actual results to differ materially from the results predicted. WSA take no responsibility or obligation to advise of changes that may in any matter affect the assumptions contained within the report, following the date of this report as they pertain to: socioeconomic and demographic forecasts, proposed residential or commercial land use development projects and/or potential improvements to the regional transportation network.

The report and its content are confidential and intended solely for use by Michigan Department of Transportation for the Detroit River International Crossing Project. Any use by third-parties, other than as noted above, is expressly prohibited. In addition, any publication of the report without the express written consent of WSA, is prohibited.

THIS PAGE INTENTIONALLY LEFT BLANK

DRAFT

TABLE OF CONTENTS

	<u>PAGE NUMBER</u>
EXECUTIVE SUMMARY	ES-1
Project Description and Background	ES-2
Current Border Crossing Conditions	ES-3
Current Detroit/ Windsor Traffic Trends	ES-3
Projected Detroit/ Windsor Border Crossing Demand Trends	ES-5
Border Crossing Toll Rates	ES-5
Model Development Summary	ES-7
Traffic Summary	ES-7
Average Weekend and Annual Transactions	ES-8
CHAPTER 1 – INTRODUCTION	1-1
Objective and Scope of Study	1-1
Detroit River International Crossing Project Description	1-5
Detroit River International Crossing – Project Alternatives	1-9
Report Structure	1-9
CHAPTER 2 – EXISTING CORRIDOR SYSTEM, TRENDS AND CHARACTERISTICS	2-1
Description of Existing Highway Facilities	2-1
Description of Existing Border Crossing Facilities	2-6
Detroit-Windsor Tunnel	2-7
Ambassador Bridge	2-8
Blue Water Bridge	2-9
Historical Border Traffic Growth Trends	2-11
Historical Border Crossing Seasonal Variations	2-14
Historical Vehicle Type Distributions	2-18
Historical Border Crossing Capture Shares	2-21
CHAPTER 3 – DATA COLLECTION AND ANALYSIS	3-1
Traffic Count Program	3-2
Local Traffic Count Collection	3-2
Border Crossing Count Collection	3-16
Border Traffic Count Summary	3-20
Origin Destination Survey	3-32
Passenger Vehicle Summary	3-32
Commercial Vehicle Summary	3-40

TABLE OF CONTENTS (CONT)

	PAGE NUMBER
Stated Preference Survey	3-43
Passenger Vehicle Summary	3-44
Commercial Vehicle Summary	3-47
CHAPTER 4 – CORRIDOR GROWTH ASSESSMENT	4-1
Regional Economic Growth	4-2
Economic Base and Trends	4-2
Key Trade Relationships	4-4
Gross Domestic Product Trends	4-6
Historical National Trends	4-8
National Border Crossing Trends	4-8
National Vehicular Traffic Demand	4-9
Fuel Price Volatility and Trends	4-10
Foreign Exchange Rate Trends	4-11
Additional Influential Factors	4-12
The Detroit Regional Economy	4-13
Population Trends and Projections	4-14
Employment Trends and Projections	4-17
Unemployment Trends	4-20
Historical Personal Income/Earning Trends	4-21
Historical Consumer Price Index Trends	4-23
The Windsor/Sarnia Regional Economy	4-24
Population Trends and Projections	4-26
Employment Trends and Projections	4-29
Unemployment Trends	4-33
Historical Household Income/Earning Trends	4-35
Historical Consumer Price Index Trends	4-36
Regional Growth Distributional Trends	4-37
Independent Economic Review	4-42
Summary of Independent Economic Review	4-42
CHAPTER 5 – MODEL DEVELOPMENT AND ENHANCEMENT	5-1
Modeling Process	5-1
Existing Travel Demand Model	5-1
Model Update Approach	5-2
Model Methodology and Process	5-3
Travel Demand Model Development	5-5
Corridor Study Area and Zone System	5-5

DRAFT

TABLE OF CONTENTS (CONT)

	<u>PAGE NUMBER</u>
Time Period Segmentation	5-6
Highway Network Update	5-8
Domestic Traffic Modeling	5-11
Development of International Travel Demand	5-13
Passenger Car Trip Tables	5-13
Commercial Vehicle Trip Tables	5-14
Development of Crossing Choice Model	5-15
Multinomial Logit Model	5-16
Nested Logit Model	5-17
Base Model Calibration/Validation	5-19
Travel Demand Model Calibration	5-20
Crossing Choice Model Validation	5-26
 CHAPTER 6 – TRAFFIC ESTIMATES	 6-1
Project Description	6-1
Key Parameters	6-3
Toll Rate Policies	6-4
Border Crossing Time	6-8
Corridor Growth	6-10
Weekend Traffic and Seasonal Variation	6-11
Crossing Share Analysis	6-12
Travel Time Saving Analysis	6-14
Annual Traffic Basic Assumptions	6-18
Annual Traffic Estimate	6-19
Annual Average Weekday Transactions	6-21
 CHAPTER 7 – SENSITIVITY ANALYSIS AND RISK ASSESSMENT	 7-1
Risk Assessment Methodology	7-2
Sensitivity Analysis	7-2
Toll Rate Policy/Levels	7-3
Border Crossing Time	7-10
Crossing Choice Model	7-15
Corridor Growth	7-19

ILLUSTRATIONS

<u>FIGURE</u>	<u>PAGE</u>
ES-1 Detroit River International Crossing Location Map	ES-2
ES-2 United States – Canada PBOA Border Crossing, 2008/2009	ES-3
ES-3 Average Weekday Border Crossing Volumes (2008)	ES-4
ES-4 Average Weekday Border Crossing Volumes (2009)	ES-4
1-1. Detroit River International Crossing Analysis Evolution	1-3
1-2. Detroit River International Crossing Location	1-7
1-3. Detroit River International Crossing Plaza and Lane Configuration	1-8
2-1. Existing Detroit Transportation Network	2-3
2-2. Existing Windsor Transportation Network	2-4
2-3. Existing Port Huron/Sarnia Transportation Network	2-6
2-4. Detroit-Windsor Tunnel Configuration	2-8
2-5. Ambassador Bridge Configuration	2-9
2-6. Blue Water Bridge Configuration	2-10
2-7. United States – Canada PBOA Border Crossings, 2008/2009	2-11
2-8. Historical Annual Automobile Vehicle Crossings (1972-2009)	2-12
2-9. Historical Annual Commercial Vehicle Crossings (1972-2009)	2-13
2-10. Historical Annual Total Vehicle Crossings (1972-2009)	2-14
2-11. Ambassador Bridge Historical Seasonal Variations (2000-2009)	2-15
2-12. Detroit-Windsor Tunnel Historical Seasonal Variations (2000-2009)	2-15
2-13. Blue Water Bridge Historical Seasonal Variations (2000-2009)	2-16
2-14. Total Frontier Crossing Historical Seasonal Variations (2000-2009)	2-17
2-15. Nine-Year Average Seasonal Variations by Crossing (2000-2009)	2-18
2-16. Ambassador Bridge Historical Commercial Vehicle Shares (2000-2009)	2-18
2-17. Detroit-Windsor Tunnel Historical Commercial Vehicle Shares (2000-2009)	2-19
2-18. Blue Water Bridge Historical Commercial Vehicle Shares (2000-2009)	2-20
2-19. Total Historical Commercial Vehicle/Crossing Shares (2000-2009)	2-20
2-20. Historical Buses & Miscellaneous Vehicle/Crossing Shares (2000-2009)	2-21
2-21. Ambassador Bridge Historical Crossing Capture Shares (2000-2009)	2-22
2-22. Detroit-Windsor Tunnel Historical Crossing Capture Shares (2000-2009)	2-23
2-23. Blue Water Bridge Historical Crossing Capture Shares (2000-2009)	2-24
2-24. Historical Total Crossing Capture Shares (2000-2009)	2-24
3-1. Detroit Region Traffic Count Locations	3-5
3-2. Detroit Region Traffic Count Summary (2008)	3-6
3-3. Detroit Region Truck Traffic Summary (2008)	3-7
3-4. Detroit Region Historical Traffic Summary	3-8
3-5. Port Huron Region Traffic Count Locations	3-9

ILLUSTRATIONS (CONT)

<u>FIGURE</u>	<u>PAGE</u>
3-6. Port Huron Region Traffic Count Summary (2008)	3-9
3-7. Port Huron Region Truck Traffic Summary (2008)	3-10
3-8. Port Huron Region Truck Traffic Summary (2009)	3-11
3-9. Windsor Region Traffic Count Locations	3-13
3-10. Windsor Region Traffic Count Summary (2008)	3-14
3-11. Windsor Region Traffic Count Comparison (2008/2009)	3-15
3-12. Windsor Region Truck Traffic Summary (2009)	3-16
3-13. Traffic Count Locations at the US side for the Traffic Entering US through the Ambassador Bridge	3-18
3-14. Traffic Count Locations at Blue Water Bridge	3-20
3-15. Average Weekday Border Crossing Volumes (2008)	3-21
3-16. Average Weekday Border Crossing Volumes (2009)	3-21
3-17. Ambassador Bridge Daily Automobile Traffic Distribution	3-22
3-18. Ambassador Bridge Daily Truck Traffic Distribution	3-23
3-19. Detroit-Windsor Tunnel Daily Automobile Traffic Distribution	3-23
3-20. Detroit-Windsor Tunnel Daily Truck Traffic Distribution	3-24
3-21. Blue Water Bridge Daily Automobile Traffic Distribution	3-24
3-22. Blue Water Bridge Daily Truck Traffic Distribution	3-25
3-23. Ambassador Bridge Vehicle Classification Summary (2009)	3-27
3-24. Detroit-Windsor Tunnel Vehicle Classification Summary (2008)	3-28
3-25. Blue Water Bridge Vehicle Classification Summary (2009)	3-28
3-26. Ambassador Bridge Weekday/Weekend Traffic Distribution (2009)	3-29
3-27. Detroit-Tunnel Weekday/Weekend Traffic Distribution (2008)	3-30
3-28. Blue Water Bridge Weekday/Weekend Traffic Distribution (2009)	3-30
3-29. Ambassador Bridge Weekday Period Distribution (2009)	3-31
3-30. Detroit Tunnel Weekday Period Distribution (2009)	3-31
3-31. Blue Water Bridge Weekday Period Distribution (2009)	3-32
3-32. Weekday Passenger Car Trip Origins & Destinations	3-35
3-33. Location of Super Zones	3-36
3-34. Weekday Passenger Car O/D Trip Characteristics	3-39
3-35. Commercial Vehicle Traffic Characteristics	3-43
3-36. Passenger Car Stated Preference Behavior by Crossing	3-45
3-37. Primary Reasons of Passenger Cars for Never Selecting the New Bridge Option by Crossing	3-46
3-38. Primary Reasons of Passenger Cars for Selecting the New Bridge Option by Crossing	3-47

ILLUSTRATIONS (CONT)

<u>FIGURE</u>	<u>PAGE</u>
3-39. Commercial Vehicle Stated Preference Behavior by Crossing	3-48
3-40. Primary Reasons of Commercial Vehicles for Never Selecting the New Bridge Option by Crossing	3-49
3-41. Primary Reasons of Commercial Vehicles for Selecting the New Bridge Option by Crossing	3-50
4-1. Historical and Projected Regional Population Trends	4-3
4-2. Historical and Projected Regional Employment Trends	4-4
4-3. Historical U.S./Canada Trade Value Trends (Port Huron and Detroit)	4-6
4-4. Historical and Projected Regional Gross State Product Trends	4-7
4-5. Historical Total United States-Canada Border Crossing Trends	4-8
4-6. Historical Vehicle Miles Traveled Growth Trends	4-9
4-7. Historical Average Retail Fuel Prices Trends	4-10
4-8. Historical and Projected Gasoline and Oil Trends	4-11
4-9. U.S./Canada Foreign Exchange Rate Trends	4-12
4-10. South East Michigan County Boundaries	4-14
4-11. Historical and Projected Regional Population Trends	4-15
4-12. Historical County Population Trends	4-16
4-13. 2007 SEMCOG County Population Share	4-17
4-14. Historical and Projected Regional Employment Trends	4-18
4-15. Historical SEMCOG County Employment Trends	4-19
4-16. 2007 SEMCOG County Employment Share	4-20
4-17. County and Regional Unemployment Trends	4-21
4-18. Historical Regional Personal Income Trends	4-22
4-19. SEMCOG County Personal Income Trends	4-23
4-20. Historical Consumer Price Index Growth Trends	4-24
4-21. Essex County Municipal Boundaries	4-25
4-22. Historical and Projected Regional Population Trends	4-27
4-23. Historical Municipal Population Trends	4-28
4-24. 2009 Essex County Municipal Population Share	4-29
4-25. Historical and Projected Regional Employment Trends	4-30
4-26. Quarterly Short-term Labor Force/Employment Trends	4-31
4-27. Historical Municipal Labor Force and Employment Trends	4-32
4-28. 2006 Essex County Municipal Labor Force and Employment Share	4-33
4-29. Municipal and Regional Unemployment Trends	4-34
4-30. Historical Regional Household Income Trends	4-35
4-31. 2006 Essex County Municipal Average and Median Household Income	4-36

ILLUSTRATIONS (CONT)

<u>FIGURE</u>	<u>PAGE</u>
4-32. Historical Consumer Price Index Growth Trends	4-37
4-33. Combined Regional Population Growth	4-38
4-34. Combined Regional Employment Growth	4-39
4-35. Combined Disaggregate Population Growth	4-40
4-36. Combined Disaggregate Employment Growth	4-41
4-37. Population Growth Indices	4-43
4-38. Employment Growth Indices	4-44
4-39. Trade/GDP Growth Indices	4-45
4-40. Total Frontier Growth Forecast Comparison	4-46
5-1. Detroit River International Crossing Study Modeling Process Flowchart	5-3
5-2. Corridor Study Area	5-5
5-3. Detroit Screenline Traffic Period Distribution	5-7
5-4. Windsor Screenline Traffic Period Distribution	5-7
5-5. Highway Network Improvements	5-8
5-6. SEMCOG Domestic Trip Table Adjustment	5-12
5-7. Configuration of Two-Level Nesting Structure	5-18
5-8. Configuration of Three-Level Nesting Structure	5-18
5-9. Location of Model Validation Screenline and Cordon Line	5-22
5-10. Travel Demand Model Validation Results	5-23
5-11. Travel Time Routes for Model Validation	5-25
5-12. Passenger Car Crossing Choice Model Calibration Results	5-29
5-13. Commercial Vehicle Crossing Choice Model Calibration Results	5-30
5-14. Location of Super Zones	5-32
5-15. Passenger Car Crossing Choice Model Calibration in OD Pairs	5-33
5-16. Commercial Vehicle Crossing Choice Model Calibration in OD Pairs	5-33
6-1. Preferred DRIC Alignment	6-3
6-2. Historical Passenger Cash Toll Rates at the Three Existing Crossings	6-6
6-3. Consumer Price Index (CPI) of Michigan and Ontario	6-7
6-4. Passenger Car Crossing Share with Multinomial Logit Model	6-13
6-5. Commercial Vehicle Crossing Share with Multinomial Logit Model	6-13
6-6. Total Crossing Share with Multinomial Logit Model	6-13
6-7. 2025 Travel Time Comparison between Highway 401 and I-75/Pennsylvania Road	6-15
6-8. 2025 Travel Time Comparison between Highway 401 and I-96/Beech Daly Road	6-16

DRAFT

ILLUSTRATIONS (CONT)

<u>FIGURE</u>	<u>PAGE</u>
6-9. 2025 Travel Time Comparison between Huron Church Road /EC Row Expressway and Bridge	6-17
7-1. Crossing Shares - DRIC Toll Rate Sensitivity	7-4
7-2. Crossing Shares - Ambassador Bridge Toll Rate Sensitivity	7-5
7-3. Crossing Shares - Detroit-Windsor Tunnel Toll Rate Sensitivity	7-6
7-4. Crossing Shares - Blue Water Bridge Toll Rate Sensitivity	7-7
7-5. Traffic Index of the DRIC from Toll Rate Sensitivity Tests	7-9
7-6. Crossing Shares - DRIC Border Crossing Time Sensitivity	7-11
7-7. Crossing Shares - Ambassador Bridge Border Crossing Time Sensitivity	7-12
7-8. Crossing Shares - Detroit-Windsor Tunnel Border Crossing Time Sensitivity	7-13
7-9. Crossing Shares - Blue Water Bridge of Border Crossing Time Sensitivity	7-14
7-10. Traffic Index of the DRIC from Border Crossing Time Sensitivity Tests	7-15
7-11. Crossing Shares of Crossing Choice Model Sensitivity Tests	7-17
7-12. Traffic Index of the DRIC from Crossing Choice Model Sensitivity Tests	7-18
7-13. Traffic Projection - Corridor Growth Assumptions	7-20

TABULATIONS

<u>TABLE</u>	<u>PAGE</u>
ES-1 Passenger Car Toll Rate (\$U.S.)	ES-6
ES-1 Commercial Vehicle Toll Rate (\$U.S.)	ES-6
ES-3 Estimated Annual Average Weekday Transactions on the Proposed DRIC	ES-9
ES-4 Estimated Annual Transactions of the Proposed DRIC	ES-10
3-1 Vehicle Classification Counts in Detroit	3-3
3-2 Screenline 1 Traffic Volume Counts in Detroit	3-4
3-3 Screenline 2 Traffic Volume Counts in Detroit	3-5
3-4 Vehicle Classification Counts in Port Huron	3-8
3-5 Screenline 3 Traffic Volume Counts in Windsor	3-12
3-6 Screenline 4 Traffic Volume Counts in Windsor	3-13
3-7 Ambassador Bridge Crossing Counts	3-18
3-8 Detroit-Windsor Tunnel Crossing Counts	3-19
3-9 Blue Water Bridge Crossing Counts	3-19
3-10 Border Crossing Vehicle Axle Distribution	3-26
3-11 Weekend Traffic as a Percentage of Weekday Traffic (2009)	3-29
3-12 Passenger Car OD Survey Implementation	3-33
3-13 Passenger Car Roadside Survey Collection Results	3-34
3-14 Passenger Car Mail-back Survey Collection Results	3-34
3-15 Weekday Passenger Car OD Proportion of Trip Matrices-Ambassador Bridge	3-36
3-16 Weekday Passenger Car OD Proportion of Trip Matrices - Detroit-Windsor Tunnel	3-37
3-17 Weekday Passenger Car OD Proportion of Trip Matrices - Blue Water Bridge	3-37
3-18 Weekday Commercial Vehicle OD Proportion of Trip Matrices - Ambassador Bridge	3-40
3-19 Weekday Commercial Vehicle OD Proportion of Trip Matrices - Blue Water Bridge	3-41
3-20 Passenger Car SP Survey Respondent Sources	3-45
5-1 Highway Network Updates - 2004 to 2009	5-9
5-2 Highway Network Updates – 2015 and 2035	5-10
5-3 SEMCOG Domestic Trip Table Adjustment Factors	5-12
5-4 Passenger Car OD Survey Sample Summary	5-13
5-5 Commercial Vehicle Survey Sample Summary	5-15
5-6 Stated Preference Observations	5-15
5-7 MNL Model Specifications for Automobile and Commercial Vehicle	5-16
5-8 Automobile MNL Coefficients	5-17

TABULATIONS (CONT)

<u>TABLE</u>	<u>PAGE</u>	
5-9	Commercial Vehicle Driver MNL Coefficients	5-17
5-10	NL Coefficients for Automobile Drivers	5-19
5-11	NL Coefficients for Commercial Vehicle Drivers	5-19
5-12	Domestic Trip Matrices Hour to Period Conversion Factor	5-21
5-13	Travel Time Validation – Windsor	5-24
5-14	Travel Time Validation in Detroit - AM Peak	5-25
5-15	Travel Time Validation in Detroit - PM Peak	5-25
5-16	Passenger Car Crossing Shares	5-27
5-17	Commercial Vehicle Crossing Shares	5-28
5-18	Calibrated Multinomial Logit Model	5-31
5-19	Calibrated Nested Logit Model	5-31
6-1	Passenger Car Toll Rate (\$U.S.)	6-4
6-2	Commercial Vehicle Toll Rate (\$U.S.)	6-5
6-3	Passenger Car Toll Rate Adjustment (\$U.S.)	6-5
6-4	Commercial Vehicle Border Crossing Time from Previous Studies	6-9
6-5	Commercial Vehicle Daily Border Crossing Time	6-9
6-6	Passenger Car Border Crossing Time	6-10
6-7	Growth Index of Frontier International Traffic	6-11
6-8	Estimated Annual Transaction on the Proposed DRIC (in Thousands)	6-20
6-9	Estimated Annualization Factors for the Proposed DRIC	6-21
6-10	Estimated Annual Average Weekday Transactions on the Proposed DRIC	6-22
7-1	Toll Rate Sensitivity Test Scenarios	7-3
7-2	Border Crossing Time Sensitivity Test Scenarios	7-10
7-3	Logit Model Sensitivity Test Scenarios	7-16
7-4	Crossing Share Comparison of Multinomial and Nested Logit Model	7-19

EXECUTIVE SUMMARY

The Wilbur Smith Associates (WSA) team – comprised of Wilbur Smith Associates, IBI Group (consultant for the DRIC-EIS study model development), Resource Systems Group Inc. (a nationally recognized stated preference and behavioral market research firm), and the Centre for Spatial Economics (an independent economic forecasting firm) – was retained by the Michigan Department of Transportation (MDOT) to refresh the comprehensive traffic study undertaken in 2008 on behalf of Transport Canada for the new proposed Detroit River International Crossing (DRIC) within the Detroit-Windsor region. This analysis is part of MDOT’s ongoing efforts to collect and update relevant data to support the evaluation of the traffic and revenue potential of the DRIC, as part of the public-private partnership procurement that MDOT and the Partnership may undertake, to fund and build the proposed bridge infrastructure.

The following report provides a summary of all the relevant efforts undertaken to evaluate the DRIC project and provides a summary the initial traffic results only. The revenue analysis for the project is ongoing and will be submitted to MDOT at a later date.

PROJECT DESCRIPTION AND BACKGROUND

The flow of goods, services, and capital between the United States and Canada is the largest bilateral trade relationship between any two nations in the world. Since the enactment of the 1989 U.S.-Canada Free Trade Agreement (FTA) and the subsequent North American Free Trade Agreement (NAFTA), trade between the U.S. and Canada has grown by more than 245 percent, from \$243 billion in 1994 to \$596.9 billion in 2008¹. The Detroit-Windsor Gateway is one of the busiest commercial land border crossing in North America and has historically handled over 28 percent of all U.S./Canada border crossing traffic and over 45 percent of the border crossing traffic tracked by the Public Border Operators Association (PBOA). The Detroit-Windsor Gateway consists of the two high-volume international border crossings – the Ambassador Bridge and the Detroit-Windsor Tunnel crossings at the Detroit River within the Detroit-Windsor area, and the Blue Water Bridge in the Port Huron-Sarnia region. In addition, the Detroit-Windsor Gateway also includes the Detroit-Windsor Truck Ferry, Canadian Pacific Railway Tunnel, the Canada National Rail Tunnel in Port Huron, and the St. Clair River Ferries (Marine City-Sombra and Algonac-Walpole Island).

The forecasted growth of commercial and passenger cross-border traffic as part of the environmental assessments over the next 30 years were projected to exceed the capacity

¹ U.S. Bureau of Transportation Statistics

of the existing crossings as early as 2015, under certain project scenarios. The U.S.-Canada-Michigan-Ontario Border Transportation Partnership (the Partnership) – consisting of the U.S. Federal Highway Administration, the Michigan Department of Transportation, Transport Canada, and the Ontario Ministry of Transportation – was formed to address and develop a long-term solution that will service the various projected markets and accommodate the expected traffic volume growth. The DRIC was proposed as a viable solution to the long-term need and will provide a new end-to-end 1.8 mile (2.9 kilometer) long, six-lane bridge crossing, which in concert with the Windsor-Essex Parkway, will link Highway 401 to the I-75 and U.S. interstate system.

The DRIC will be located southwest of the existing Ambassador Bridge, as shown in **Figure ES-1**. The proposed new bridge is assumed for purposes of this report to be built and open to traffic by January, 2016, and will operate as a tolled facility with cash and electronic toll collection options.



Figure ES-1. Detroit River International Crossing Location Map

The proposed new bridge and its connecting links have received the respective environmental approvals from both countries. The U.S. and Canadian project teams are pursuing the required permits in their respective countries, and the exact configuration of the two bridge plazas are still in the development stages. The proposed inspection center on the U.S. side will be located between the Detroit River in the south and the direct

interchange connecting to the I-75 in the north. The proposed Canadian inspection center will be bound by Broadway Street to the south, Chappus Street to the north, the Detroit River to the west, and the Essex Terminal Railway line on the east. The connection to Highway 401 on the Canadian side will be made through the construction of the Windsor-Essex Parkway, which is assumed to be open by 2016.

CURRENT BORDER CROSSING CONDITIONS

The three combined Southeast Michigan/Southwest Ontario crossings in 2009 captured 14.98 million vehicles (45.4 percent of overall PBOA member vehicular traffic), and 3.70 million commercial vehicles (62.2 percent of the overall PBOA member commercial border crossing traffic). The Ambassador Bridge, Detroit-Windsor Tunnel, and Blue Water Bridge are among the five busiest PBOA monitored passenger vehicle crossings between the United States and Canada, as shown in **Figure ES-2**. The Ambassador Bridge currently carries the highest commercial vehicle traffic of all PBOA member border crossings between the United States and Canada.

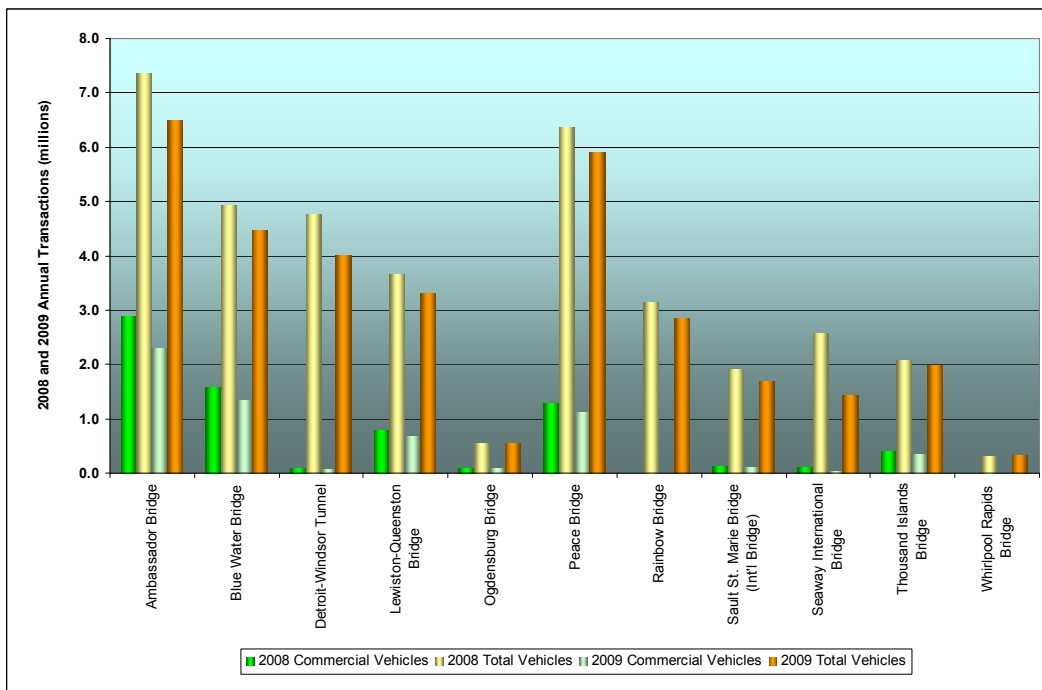

Figure ES-2. United States – Canada PBOA Border Crossings, 2008/2009

CURRENT DETROIT/ WINDSOR TRAFFIC TRENDS

A traffic count program was implemented to capture the hourly variations of current passenger and commercial vehicle demand at the Detroit/Windsor border crossings. In addition, a review of the historical and current trend of regional traffic was undertaken to

gauge the congestion characteristics that may influence the border crossing choice. The counts collected in November 2009 showed declines in overall daily traffic demand at the three crossings within the study area. The average weekday traffic volumes at the existing crossings within the Detroit/Windsor and Port Huron/Sarnia regions that were collected in April/May 2008 are summarized in **Figure ES-3**, along with the 2009 counts collected in November, as shown in **Figure ES-4**. The more recently captured 2009 traffic counts showed very similar directional patterns to the 2008 levels and showed that the Blue Water Bridge and Detroit-Windsor Tunnel captured slightly higher truck traffic volumes, while slight declines were captured at the Ambassador Bridge.

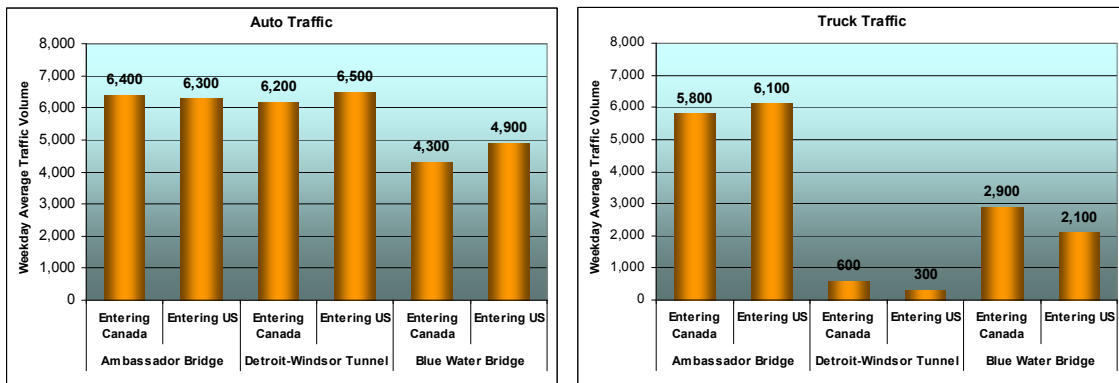
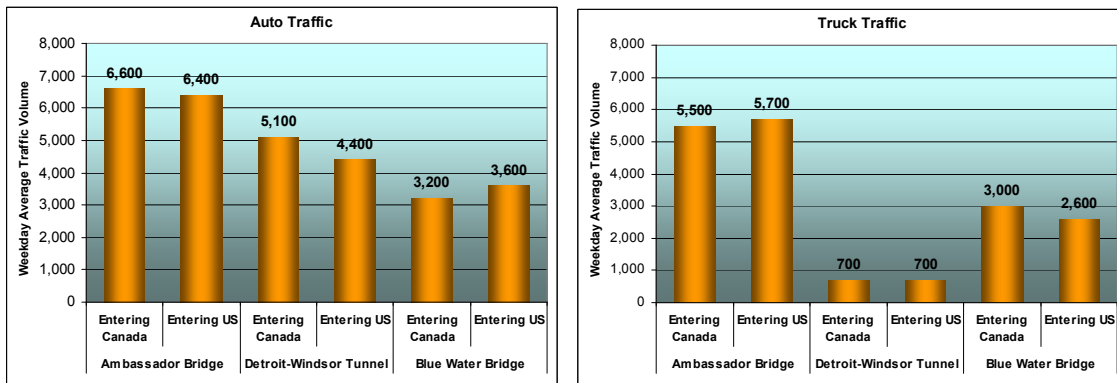

Figure ES-3. Average Weekday Border Crossing Volumes (2008)



Note: 2009 Detroit-Windsor Tunnel volumes reflect the unadjusted captured volumes that include the anomalies in the axle distributions.

Figure ES-4. Average Weekday Border Crossing Volumes (2009)

Further evaluation of the Detroit-Windsor Tunnel counts demonstrated anomalies in the directional split of both passenger cars and commercial vehicles and upon further review was found to be unreliable. A recount effort was not plausible due to the holiday season that would typically have skewed the normal travel patterns, therefore the 2008 auto and truck classification and hourly distributions were used as a reasonable proxy for the distributional characteristics. The Public Border Operators Association (PBOA) data was

used to gauge the magnitude of daily traffic at the Detroit-Windsor Tunnel for the 2009 calibration.

PROJECTED DETROIT/ WINDSOR BORDER CROSSING DEMAND

An independent economic assessment of the projected frontier corridor traffic growth was undertaken to update the 2008 comprehensive study efforts and incorporate the recent economic trends that occurred over the last two years within the Detroit/Windsor region. This study performed a corridor growth assessment of traffic demand across the three crossings spanning the Detroit River and the St. Clair River, within the Detroit-Windsor region known as “the frontier,” which includes the Ambassador Bridge, the Detroit-Windsor Tunnel, and Blue Water Bridge.

Many socio-economic variables were investigated to evaluate their correlation to the growth in border crossing demand using a multivariate regression analysis approach to test for multiple market segmentations. The final three market segments used to determine the overall corridor growth of traffic across the frontier were the same-day travelers (with a sub-market segmentation of work/commute and other/recreational), overnight travelers, and commercial vehicles. The most significant socio-economic variables found to best describe the historical demand for these three markets were:

- Same-Day Passenger Vehicles (work/commuter): sum of Michigan and Ontario employment;
- Same-Day Passenger Vehicles (other/recreational): SEMCOG 2035 Regional Transportation Plan (RTP) population and Windsor-Sarnia employment with a 911 dummy variable;
- Overnight Passenger Vehicles: sum of Michigan and Ontario population; and
- Commercial Vehicles: Ontario’s Foreign Trade Turnover (imports plus exports) and Foreign Exchange Rates between U.S./Canada.

BORDER CROSSING TOLL RATES

Passenger car tolls can be paid either by cash or a “commuter” token at all three existing crossings in either U.S. or Canadian dollars. **Table ES-1** shows the current passenger car toll rates for both cash and token payment. The Detroit-Windsor Tunnel currently assesses different cash toll rates for different directions when tolls are paid with Canadian dollars.

Crossing	Direction	Effective Date	Cash Rate	Discount Rate
Ambassador Bridge	To Canada	February 1, 2009	\$4.00	\$3.50
	To US		\$4.00	\$3.50
Detroit-Windsor Tunnel*	To Canada	December 1, 2009	\$4.00	\$3.50
	To US		\$4.00	\$3.50
Blue Water Bridge	To Canada	September 1, 2009	\$1.50	\$1.50
		January 5, 2010	\$3.00	\$2.00
	To US*	December 1, 2009	\$3.00	\$2.00

Note: 1. The toll rates for Canadian dollars are higher than paid with U.S. dollars at all crossings except for the Blue Water Bridge.

2. Discount rate at Ambassador Bridge was estimated based on the special discounts for reward card and NEXUS card.

* Reflects rates as of December 1, 2009.

The current commercial vehicle toll rates are assessed with different tolling schemes at the three existing crossings, as shown in **Table ES-2**. The Ambassador Bridge commercial vehicle tolling scheme has three classes whereby each class is charged a different per-axle toll rate and also takes into account the weight of the trucks. The Detroit-Windsor Tunnel commercial vehicle tolling scheme uses a gross weight approach with identical toll rates in both directions if paid in U.S. currency and a directional differential in the minimum toll rates for tolls that are paid with Canadian currency. The Blue Water Bridge assesses the toll charges of trucks by axles.

The different tolling schemes at the three crossings result in varied tolls being paid by individual commercial vehicles and warranted that the commercial toll rates used as part of the analysis be weighted to reasonably reflect the actual tolls that each commercial vehicle market would likely encounter. This was based on the existing profile of the commercial markets using the existing crossings that was captured from the OD surveys, and the axle distributions captured as part of the traffic count collection.

Crossing	Effective Date	Toll Rate
Ambassador Bridge	February 1, 2009	Class A: 0-38,000lbs, \$2.75/axle
		Class B: 38,001-56,000lbs, \$3.25/axle
		Class C: 56,001-145,000lbs, \$4.50/axle
Detroit-Windsor Tunnel*	December 1, 2009	To Canada: \$0.030 per 100lbs gross weight
		To US: \$0.030 per 100lbs gross weight
Blue Water Bridge – To Canada	September 1, 2009	\$1.75/axle
	January 5, 2010	\$2.50/axle
Blue Water Bridge - To US*	December 1, 2009	\$3.25/axle

Note: Canadian dollar paid toll rates are higher than the U.S. dollar paid rates at all crossings except for the Blue Water Bridge.

*Reflect rates as of December 1, 2009.

MODEL DEVELOPMENT SUMMARY

The existing travel demand model used for this study was originally developed in 2000 for the P/N&F study, and was then updated for the DRIC-EIS study in 2004. The P/N&F regional model was developed from three pre-existing models: Southeast Michigan Council of Governments (SEMCOG) model covering southeast Michigan, Windsor Area Long Range Transportation Study (WALTS) model covering the greater Windsor area, and the Ontario Ministry of Transportation (MTO) truck model, which focused primarily on Ontario, but also covered North America. The new traffic counts and speed profiles collected as part of this refresh study were used to verify the previously calibrated regional models. The models were used to validate the 2009 crossing choice model, which was developed from the stated preference survey data collected as part of the 2008 comprehensive study. The approach undertaken as part of the refresh study included:

- Updating the road network to incorporate the new highway improvement program in SEMCOG's 2035 Regional Transportation Plan (Direction 2035) and in WALTS for city of Windsor;
- Incorporating the selected preferred alternative of the proposed new Detroit River International Crossing (DRIC) into the road network;
- Calibrating the domestic trip tables on both U.S. and Canada sides to reflect current traffic profile;
- Updating the base international trip tables with the comprehensive passenger car origin-destination survey conducted in April 2008;
- Updating the base commercial vehicle trip tables with the national roadside survey/commercial vehicle survey (NRS/CVS) efforts which included a commercial vehicle origin-destination survey performed by MTO in 2006;
- Updating of the passenger car and commercial vehicle trip tables based on the 2009 border crossing traffic counts collected as part of this refresh;
- Incorporating a discrete choice model to represent the motorists' decision-making behavior based on the comprehensive stated-preference survey conducted in April 2008; and
- Calibrating the international and local models to 2009 levels using the 2008 extensive traffic counts and the 2009 spot traffic counts collected on both the Canada and United States side of the existing crossings.

TRAFFIC SUMMARY

The annual traffic estimates for the proposed DRIC were developed based on the following basic assumptions:

- The new crossing is assumed to open to traffic by January, 2016;

- Accessibility to the DRIC Bridge includes a freeway-to-freeway connectivity, and good accessibility to the regional roadways that are complemented by some new improvements within the current regional highway improvements plans on both sides of the bridge;
- Key variables such as border crossing travel times, corridor growth, seasonality, border crossing choices, and toll rate sensitivities were developed based on recently collected and available data;
- Toll rates and border processing times for the DRIC baseline were pegged to the existing Ambassador Bridge and are assumed to remain at parity in the future;
- Ramp-up is assumed to be modest at 90 percent in the first year and 95 percent in the second year, given that this bridge project has been discussed publicly for many years and is in close proximity to the existing crossings; and
- The crossing choice model that was developed based on the stated-preference survey efforts conducted in 2008 was calibrated to the 2009 existing revealed crossings choices.

AVERAGE WEEKDAY AND ANNUAL TRANSACTIONS

The DRIC is projected to yield a border crossing travel time saving that will range between 2.0 to 8.0 minutes compared to the existing crossings by 2025 for select representative long-distance movements. The DRIC will capture 34.5 percent of the overall combined 2025 traffic along the four frontier border crossings within the Detroit/Windsor/Port Huron/Sarnia region. The new crossing will result in an average overall traffic share reduction of 20.5 percent at the Ambassador Bridge, 7.2 percent reduction at the Detroit-Windsor Tunnel, and a 6.9 percent reduction at the Blue Water Bridge.

The DRIC is expected to capture 27.6 percent of the total passenger vehicle traffic and 44.2 percent of the overall commercial vehicle traffic by 2025. The new crossing will result in a 2025 average passenger vehicle share reduction of 12.7 percent at the Ambassador Bridge, an 11.8 percent reduction at the Detroit-Windsor Tunnel, and a 3.2 percent reduction at the Blue Water Bridge. The 2025 commercial vehicle shares as a result of the new crossing will yield a 31.5 percent reduction in the Ambassador Bridge commercial vehicle shares, while the Blue Water Bridge will experience a 12.1 percent reduction in its commercial vehicle share.

The annual average weekday traffic for the DRIC was calculated for the opening year and the other three future years, as shown in **Table ES-3**. The total traffic shown in the table includes some miscellaneous traffic, in addition to the passenger car and commercial vehicle markets. The DRIC is anticipated to attract approximately 9,000 passenger cars and 9,500 commercial vehicles during a normal weekday by the opening year of 2016. These will by 2025 grow to 12,800 and 13,500 for the passenger car and commercial vehicle, respectively. The DRIC is therefore expected to serve a total of approximately

26,500 daily vehicles by 2025, and over 37,100 by 2040 when the miscellaneous traffic is included.

Table ES-3			
Estimated Annual Average Weekday Transactions on the Proposed DRIC			
Year	Passenger Car	Commercial Vehicle	Total Weekday Traffic¹
2016	9,000	9,500	18,700
2025	12,800	13,500	26,500
2035	17,500	16,900	34,600
2040	18,500	18,400	37,100

Note: The total transactions of average weekday include passenger cars, commercial vehicles and miscellaneous traffic such as motorcycles.

The baseline traffic estimates are shown in **Table ES-4**. The total traffic listed in the table includes passenger car, commercial vehicle and a small percentage of miscellaneous classified traffic (motorcycles etc.), which was assumed based on the historical transactions at the Ambassador Bridge. The DRIC is expected to attract approximately 5.9 million vehicles annually in both directions in the opening year (2016), and is forecasted by 2025 to capture 8.4 million vehicles, representing an average annual growth rate of 4.0 percent (with ramp-up included).

Table ES-4 Estimated Annual Transactions on the Proposed DRIC (in Thousands)			
	Passenger Car	Commercial Vehicles	Total*
2016	3,073	2,747	5,862
2017	3,259	2,985	6,290
2018	3,448	3,234	6,730
2019	3,466	3,327	6,842
2020	3,524	3,423	6,997
2021	3,635	3,519	7,205
2022	3,790	3,616	7,459
2023	3,975	3,716	7,746
2024	4,204	3,819	8,080
2025	4,418	3,921	8,398
2026	4,651	4,022	8,736
2027	4,868	4,122	9,054
2028	5,069	4,221	9,357
2029	5,227	4,316	9,612
2030	5,384	4,411	9,866
2031	5,529	4,505	10,106
2032	5,650	4,597	10,321
2033	5,772	4,689	10,536
2034	5,894	4,780	10,751
2035	6,000	4,870	10,948
2036	6,108	4,959	11,147
2037	6,170	5,048	11,299
2038	6,231	5,137	11,450
2039	6,291	5,225	11,599
2040	6,351	5,312	11,747
2041	6,411	5,399	11,894
2042	6,470	5,485	12,041
2043	6,529	5,570	12,186
2044	6,588	5,654	12,330
2045	6,656	5,739	12,485
2046	6,724	5,824	12,638
2047	6,792	5,908	12,791
2048	6,859	5,991	12,943
2049	6,927	6,072	13,093
2050	6,995	6,153	13,242
2051	7,063	6,232	13,391
2052	7,131	6,312	13,540
2053	7,199	6,393	13,690
2054	7,267	6,475	13,841
2055	7,335	6,558	13,993
2056	7,404	6,641	14,146
2057	7,472	6,726	14,300
2058	7,541	6,811	14,455
2059	7,609	6,898	14,612
2060	7,678	6,985	14,769
2061	7,747	7,073	14,927
2062	7,816	7,163	15,086
2063	7,885	7,253	15,247
2064	7,954	7,344	15,409
2065	8,024	7,437	15,578

* The total transactions include passenger cars, commercial vehicles and miscellaneous traffic such as motorcycles. The annualization reflects consideration for seasonal variations and weekend traffic trends.

CHAPTER 1

INTRODUCTION

Wilbur Smith Associates (WSA) was retained by Michigan Department of Transportation (MDOT), in coordination with the Canada-U.S.-Ontario-Michigan Border Transportation Partnership (the Partnership) — consisting of Transport Canada (TC), the U.S. Federal Highway Administration, Transport Canada, the Ontario Ministry of Transportation, and the Michigan Department of Transportation — to conduct a refresh of the 2008 study conducted by Transport Canada for the new proposed Detroit River International Crossing (DRIC) within the Detroit-Windsor region. This analysis is part of MDOT’s ongoing efforts to evaluate the financial feasibility of a tolled bridge as part of the proposed DRIC. The study draws upon an extensive effort previously undertaken as part of the Planning/Need and Feasibility (P/N&F) Study, Detroit River International Crossing (DRIC-EIS) Study, the 2008 comprehensive study submitted to Transport Canada, and numerous other transportation modeling studies that were conducted to identify long-term strategies to meet the needs of the transportation network serving the border between southeast Michigan and southwestern Ontario and to support the environmental process.

The purpose of the initial 2008 comprehensive study and this refresh was to collect and update relevant data to support the evaluation of the traffic potential of the DRIC, and to support MDOT and the Partnership in their evaluation of financial mechanisms to fund and build the proposed bridge infrastructure.

OBJECTIVE AND SCOPE OF STUDY

The Detroit-Windsor Gateway is one of the busiest commercial land border crossing in North America and handles more than 28 percent of all U.S.-Canada border crossing traffic. The Detroit-Windsor Gateway consists of the two high-volume international border crossings – the Ambassador Bridge and the Detroit-Windsor Tunnel crossings at the Detroit River within the Detroit-Windsor area. In addition, the Detroit-Windsor

Gateway also includes the Detroit-Windsor Truck Ferry, Canadian Pacific Railway Tunnel, the Canada National Rail Tunnel in Port Huron, and the St. Clair River Ferries (Marine City-Sombra and Algonac-Walpole Island). The forecasted growth of commercial and passenger cross-border traffic, under certain project scenarios, has been projected to exceed the capacity of the existing crossings as early as 2015, under certain project scenarios. The U.S.-Canada-Michigan-Ontario Border Transportation Partnership (the Partnership) — consisting of the Michigan Department of Transportation, the U.S. Federal Highway Administration, Transport Canada, and the Ontario Ministry of Transportation — was formed to address and develop a long-term solution that will service the various projected markets and accommodate the expected traffic volume growth.

The existing cross-border demand traveling through the region consists of a traffic mix that includes a large portion of commuter traffic, recreational/vacation traffic, and commercial vehicular traffic – 90 percent of which is tractor trailer vehicles. The 2004 Planning/Need and Feasibility (P/N&F) Study identified a long-term need for a new crossing and the bi-national (U.S.-Canada) governance began exploring various mechanisms to finance, design, construct, and operate the new crossing. A key component necessary to implementing such a partnership includes a detailed assessment of the traffic potentials for the facility to assist decision makers in quantifying the potential asset value. Performing a traffic valuation of the new proposed crossing required detailed analyses of all underlying demographic trends, network characteristics, market characteristics, and willingness-to-pay characteristics, to produce a robust and defensible forecast to support decision makers. The comprehensive study, as outlined in this report, describes the level of detail undertaken to investigate the various characteristics of the current traffic demand within the Detroit/Windsor region, and the future projections of key elements that may affect the crossing demand and local traffic patterns within the region.

The extensive efforts undertaken as part of the P/N&F Study and Detroit River International Crossing (DRIC-EIS) Study to support the environmental process, along with the 2008 comprehensive study key tasks, are outlined in **Figure 1-1**. The refresh DRIC study draws upon the extensive databases developed through the 2008 efforts and provides an update to the traffic models based on recently collected data. The traffic models include model enhancements to account for the route choice and crossing choice characteristics obtained from the stated preference surveys.

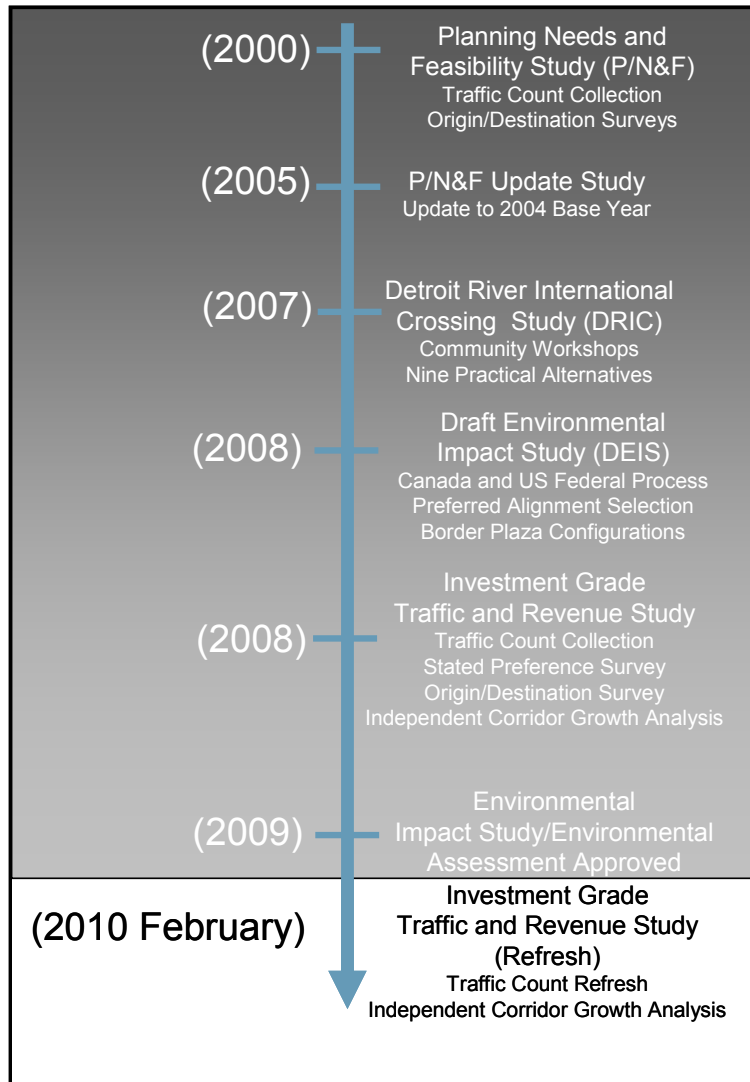

Figure 1-1. Detroit River International Crossing Analysis Evolution

The WSA team is comprised of Wilbur Smith Associates, IBI Group (current consultant for the DRIC study model development), Resource Systems Group Inc. (a nationally recognized state preference and behavioral market research firm), and the Centre for Spatial Economics (an independent economic forecasting firm). In addition, several local traffic counting firms were retained on either side of the border to capture the current traffic demands along the major facilities accessing the existing crossings within the region. The comprehensive nature of this study required that additional detailed analysis be performed beyond the typical analyses implemented as part of the environmental process. These include:

- A stated preference survey effort to capture automobile and commercial vehicle behavioral preferences and willingness-to-pay tolls. The automobile and commercial vehicle patrons were asked a series of questions regarding their willingness-to-pay tolls for border crossing trips depending on the level of benefits they receive. The results were used to develop market specific regional decision-making models that took into account multiple variables such as travelers values-of-time (a proxy to their willingness-to-pay), and identified key traveler preferences that may potentially affect their decision to use one crossing over the others;
- Identification of biases not explained by behavioral factors included in a travel demand model and model enhancements to incorporate the updated baseline information and stated preference route choice models;
- The application of enhanced traffic assignment, route selection, and toll diversion modeling techniques to improve the toll sensitivities; and
- A detailed traffic forecasts of the DRIC under the baseline assumptions that incorporate key variables.

In addition, this study also performed updates to the key inputs to the traffic forecasting process including:

- A comprehensive review of historical databases and studies. Detailed analysis of the temporal traffic distribution of the border crossing and key facilities on either side, throughout the day, and the distribution of traffic throughout the week. In addition, a detailed analysis of the current congestion characteristics along the facilities accessing the numerous existing crossings and the season variation was performed;
- A comprehensive traffic count program and refresh effort to assess current demand along the existing crossings and the key access facilities in the region. These were used to establish a baseline for projections;
- A new origin-destination survey to capture typical automobile and commercial vehicle traffic patterns and trends and to update the model trip tables in light of recent events affecting cross-border travel.
- An independent economic assessment of the local and provincial/state economic trends and key variables that affect the long-term forecast trends of international crossing traffic. An independent economic consultant with local knowledge within the Michigan/Windsor region was retained to provide an independent

evaluation of the local and provincial/state economies, and identify, as well as quantify, the key growth factors that will likely affect the study area through the forecast period. This evaluation also included an analysis of growth in the international passenger car and commercial vehicle traffic demand that are likely to use the Detroit/Windsor Crossings and incorporates the recent short-term trends that have occurred over the last two years;

- The assessment of recent economic trends (2008-2009) at the local, regional, national, and international level. This resulted in the modification of land use and economic growth outlooks to match recent levels of activity, trends, and long-term outlooks; and,
- The recalibration of the 2008 travel demand model to incorporate new traffic and travel survey data, including recent government-sponsored travel surveys.

The models were enhanced to incorporate all the new collected information and were calibrated and validated to account for the changes that were observed. The current trends in the economy and fuel prices, along with the numerous construction projects in both Detroit and Windsor in 2008, also required that extensive comparison to the historical trends be performed to normalize for these network conditions that departed from the normal operating conditions within the region.

DETROIT RIVER INTERNATIONAL CROSSING PROJECT DESCRIPTION

The Ambassador Bridge, the Detroit-Windsor Tunnel, and the Blue Water Bridge (hereafter referred to, collectively, as “the frontier”), as shown in **Figure 1-2**, are the three existing road border crossings in the Southeast Michigan region in Michigan and the Windsor-Sarnia economic region in Ontario. Trade at these international border crossings is estimated by several sources to range between one-fifth to one-third¹ of the total value in bilateral trade between United States and Canada. The U.S. Department of Homeland Security (DHS) and Canada Border Services Agency (CBSA) are the immigration border processing agencies at all the border crossings. Significant levels of traffic are channeled through the frontier border crossings, all of which traverse the geographic and political boundary at the Detroit and St. Clair Rivers. Several major freeway and arterial facilities on either side of the border provide the main access to the current border crossings, as briefly summarized below.

Detroit-Windsor Tunnel

The Detroit-Windsor Tunnel is a two-lane facility that opened to traffic in 1930 and directly connects downtown Detroit to downtown Windsor. The facility is approximately 1.0 miles (1.6 kilometers) long and currently operates as a tolled facility with toll

¹ Transport Canada; Canadian Chamber of Commerce

collection occurring at the entrance of the tunnel in both directions. Due to the limited dimensions of the tunnel and the geometric configuration of the access portals, the tunnel has restrictions on both the size and the contents of commercial vehicles that are allowed to traverse this facility. Both primary and secondary inspection facilities are available on-site on the U.S. side of the border. On the Canadian side of the border, secondary inspection of commercial vehicles is conducted at an off-site location. The tunnel connects directly to Jefferson Avenue on the Detroit side, and Park Street and Goyeau Avenue on the Windsor side – all of which are local arterial streets.

Ambassador Bridge

The Ambassador Bridge is a four-lane facility that opened to traffic in 1929 and connects from I-75 on the U.S. side to Huron Church Road in Windsor. The four-lane bridge is approximately 1.8 miles (2.8 kilometers) in length and is currently operated with one designated lane for commercial vehicles in each direction and with no lane restrictions for automobile traffic. The bridge currently operates as a tolled crossing with toll collection occurring on the U.S. side of the facility for each direction of travel. The commercial vehicle inspection facilities are located on-site for U.S.-bound traffic on the U.S. side, while a secondary facility exists on the Canadian side for Canada-bound commercial vehicle traffic. Due in part to the restrictions on commercial vehicles at the tunnel, the Ambassador Bridge services over 95 percent of the commercial traffic crossing the border in the Detroit-Windsor area. This large share of truck traffic, in concert with the multiple signalized intersections along the Huron Church Road (which provides the main arterial accessibility to the bridge on the Windsor side), has historically contributed to some operational constraints within the corridor.

Blue Water Bridge

The Blue Water Bridge opened to traffic in 1938 as a three-lane facility and eventually was expanded with the addition of a second three-lane span in 1999. The bridge traverses the St. Clair River for approximately 1.2 miles (1.9 kilometer) long and provides access between Port Huron and Sarnia. The bridge provides direct access from I-94/I-69 on the U.S. side to Highway 402 on the Canadian side. The bridge currently operates as a tolled crossing with toll collection occurring on the U.S. side for Canada-bound traffic and on the Canadian side for U.S.-bound traffic. The primary inspection sites separate the passenger and commercial vehicles for processing and the secondary inspection facilities are located on-site on either side of the crossing. The bridge serves a mix of both automobile and commercial vehicle traffic and provides direct freeway-to-freeway access for long-distance traffic.

Proposed Detroit River International Crossing

The proposed bridge crossing will provide an end-to-end new 1.8 miles (2.9 km) long, six-lane bridge crossing which in concert with the Windsor-Essex Parkway will link Highway 401 to the I-75 and U.S. interstate system. The proposed inspection center on the U.S. side will be located between the Detroit River in the south with a direct

interchange connect to the I-75 in the north. The U.S. inspection center will be bound by Campbell Street to the north, Post Street to the south, Jefferson Avenue to the west, and the NS/CSX rail line. The proposed Canadian inspection center will be bound by Broadway Street to the south, Chappus Street to the north, the Detroit River to the west, and the Essex Terminal Railway line on the east. The connection to Highway 401 on the Canadian side will be made through the construction of the Windsor-Essex Parkway, which is assumed to be open by 2015. The conceptual plaza design footprints for the U.S. and Canada are further illustrated in **Figure 1-3**.



Figure 1-2. Detroit River International Crossing Location

The proposed new bridge, for forecasting purposes, is scheduled to be built and open to traffic by January, 2016, and will operate as a tolled facility with cash and electronic toll collection options. The proposed new bridge and its connecting links received the respective environmental approvals from both countries. The U.S. and Canadian project teams are pursuing the required permits in their respective countries, and the exact configuration of the two bridge plazas are still in the development stages.

Plaza Footprint (United States)

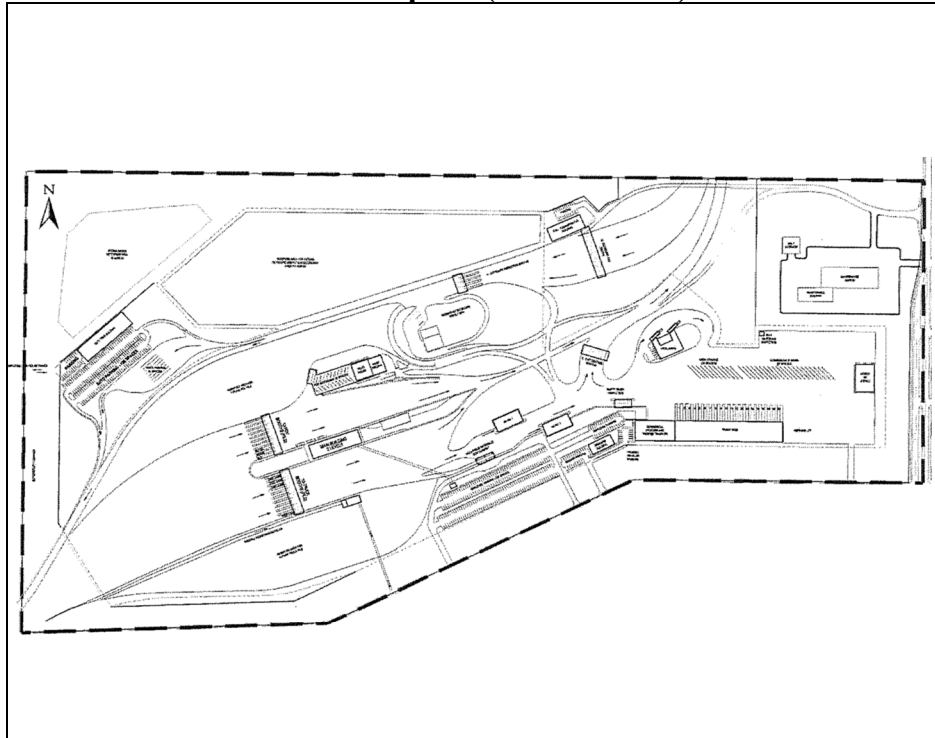

Conceptual Plaza Configuration (Canada)

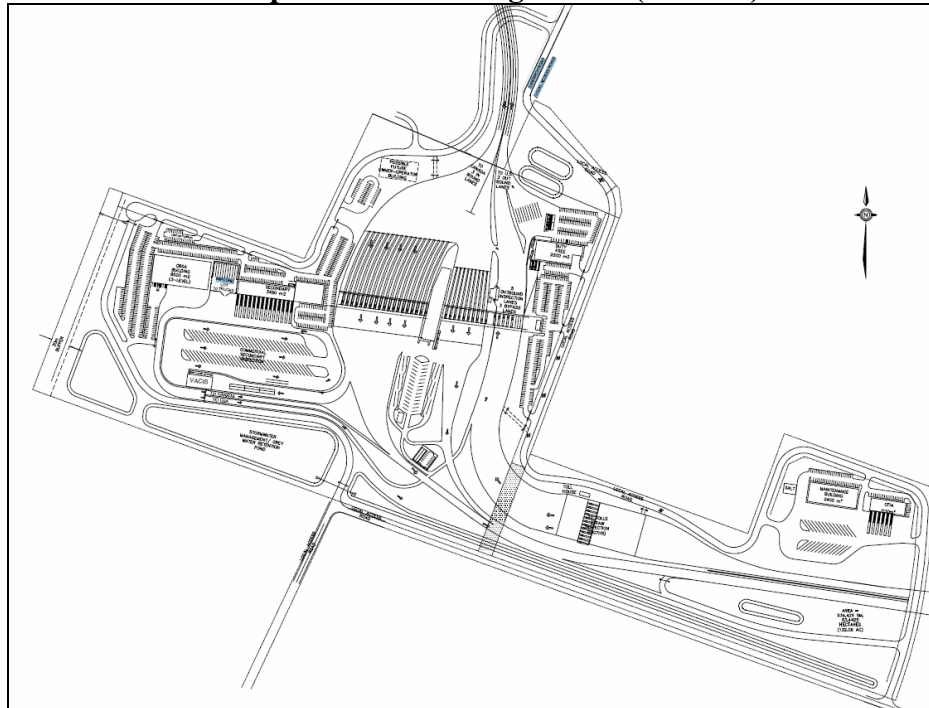

Figure 1-3. Detroit River International Crossing Plaza and Lane Configuration

DETROIT RIVER INTERNATIONAL CROSSING – PROJECT ALTERNATIVES

The Detroit River International Crossing was evaluated under a single geometric configuration as part of this study. The toll rate scenario considered for the proposed DRIC was a fixed toll regime policy similar to the Ambassador Bridge vehicle classification regime with a base passenger car toll rate of \$4.00 in 2009 dollars. The current border processing and crossing times at the Ambassador Bridge were also assumed for the DRIC in developing the baseline traffic forecasts.

REPORT STRUCTURE

This report is divided into several chapters that refer to major work elements undertaken as part of the study.

- **Chapter 2 – Existing Transportation System and Traffic Characteristics:** This section summarizes the existing transportation infrastructure on both sides of the border and describes and profiles the historical and current demand along the existing border crossing facilities.
- **Chapter 3 – Traffic Data Collection and Analysis:** New updated traffic data collected as part of this study is described and summarized in this section. The data collection efforts included a comprehensive traffic count collection program, an origin-destination survey effort, and a stated-preference survey effort. The methodologies implemented for each of these efforts are detailed, and the results are summarized and compared with the historical data that was previously collected from past studies within the region.
- **Chapter 4 – Corridor Growth Assessment:** This section describes the key economic variables within the Detroit/Windsor region along with the independent economic analysis implemented to estimate the future corridor traffic growth for various travel modes across the entire border crossing frontier. The methodology and assumptions applied in the forecasting process and the ensuing corridor growth forecasts are presented along with the rationale for the key assumptions embedded within the analysis.
- **Chapter 5 – Model Development and Enhancement:** This section describes the model enhancements implemented as part of this study. The models developed were based on the 2008 comprehensive study with modifications to account for newly collected data and more recent economic trends. This section outlines how the extensive data collection and corridor growth forecasts were incorporated into the models. The comprehensive model calibration and validation efforts

undertaken to develop the final model used to forecast the traffic estimates for the new proposed crossing are also summarized herein.

- **Chapter 6 – Traffic Estimates:** The key assumptions and estimated traffic for the Detroit River International Crossing are presented in this chapter.
- **Chapter 7 – Sensitivity Analysis and Risk Assessment:** Sensitivity analyses to quantify the potential impact of key parameters on the traffic forecast are described in this chapter. This chapter also describes the sensitivity analyses that were undertaken to investigate the key parameters that may affect the traffic estimates for the new proposed Detroit River International Crossing.

CHAPTER 2

EXISTING CORRIDOR SYSTEM, TRENDS, AND CHARACTERISTICS

The purpose of this chapter is to provide some background information pertaining to the existing transportation characteristics surrounding the proposed Detroit River International Crossing corridor in the Detroit/Windsor/Port Huron/Sarnia region. This chapter provides a summary of the historical traffic trends and characteristics along the three existing border crossings: the Ambassador Bridge, the Detroit-Windsor Tunnel, and the Blue Water Bridge. The chapter also outlines the existing highway infrastructure that will provide access to the proposed Detroit River International Crossing located within Detroit, Wayne County, and Windsor, Ontario.

The data collection efforts performed previously within the corridor include the Planning/Need and Feasibility (P/N&F) Study, Detroit River International Crossing (DRIC-EIS) Study, and numerous transportation modeling studies conducted to support the environmental process. The data collection efforts undertaken in the corridor as part of these studies were used as background information to understand the historical trends and characteristics over the past ten years, and relevant information obtained as part of this review is briefly summarized herein.

DESCRIPTION OF EXISTING HIGHWAY FACILITIES

The Detroit region has a highway network that consists of several major interstate facilities servicing the Detroit local traffic, as well as long-distance markets, as shown in **Figure 2-1**. The major facilities accessing the Detroit region include a series of radial routes with federal designations that include:

- **Interstate 94 (I-94)** – Provides the Detroit region with east-west access to southwestern Michigan and beyond. The facility runs east-west through northern Detroit and continues northwards toward Port Huron;
- **Interstate 75 (I-75)** – Provides the Detroit region with north-south access to southern Michigan and beyond. The facility approaches the Detroit region from the south and runs east-west through the Detroit downtown before turning in a north-westerly direction towards the Michigan Upper Peninsula;
- **Interstate 96 (I-96)** – Provides the Detroit region with north-westerly access to the Michigan Peninsula. The facility originates directly north of the Ambassador Bridge and runs to the eastern shore of Lake Michigan;
- **Interstate 375 (I-375)** – Provides local north-south access, on the eastern side of Detroit, from I-75 to the downtown central business district (CBD).

Several local/state designated routes within the Detroit region include:

- **John C Lodge Freeway (M-10)/East Jefferson Avenue** – Provides direct north-south local access from the northern regions of Detroit to the downtown CBD. This facility runs directly from the east into East Jefferson Avenue, which provides the main access to the existing Detroit-Windsor Tunnel crossing. East Jefferson Avenue is an eight-lane divided facility that runs along the Detroit River through the downtown CBD and directly connects eastbound traffic to the Detroit-Windsor Tunnel entrance. Westbound traffic along East Jefferson Avenue is required to make a U-turn to the west of the Detroit-Windsor Tunnel entrance to access the facility.
- **Michigan Avenue (US 12)** – Provides local traffic with north-westerly access to the Detroit CBD. This major arterial runs through the I-75/I-96 interchange and traverses in a diagonal fashion towards the Detroit CBD.



Figure 2-1. Existing Detroit Transportation Network

The Windsor region has a highway network that consists of several major highway facilities servicing the Windsor local traffic and long-distance through-traffic, as shown in **Figure 2-2**. The major facilities accessing the Windsor region includes a series of routes that include:

- **Highway 401** – Provides the major east-west access from Ontario and the rest of Eastern Canada. The facility is the primary trade corridor between the Windsor Region/Canada and the U.S., and currently terminates on the periphery of the city of Windsor at Talbot Road (Highway 3).
- **E.C. Row Expressway** – Provides an east-west facility that services local traffic within the Windsor region. This facility provides a critical link for local travelers destined from the eastern regions of Windsor.

Several local/state facilities also providing accessibility within the Windsor region include:

- **Talbot Road/Huron Church Road** – Talbot Road provides the existing north-south access from the Highway 401 that then merges into Huron Church Road, which serves as a local arterial with signalized intersections as it approaches and merges into the Ambassador Bridge. The Huron Church Road is a 6-lane arterial

with speed restrictions, where trucks are encouraged to use the center lane of the facility in each direction to/from the Ambassador Bridge. The facility has numerous signalized intersections that in effect meters traffic from Highway 401 towards the Ambassador Bridge.

- **Ouellette Avenue/Dougall Avenue** – This local four-lane street (with several six-lane segments) provides north-south access from the Windsor CBD to the E.C. Row Expressway and Highway 401. This corridor is connected to the Detroit-Windsor Tunnel via Goyeau Street. Truck traffic restrictions along this corridor during certain hours of the day, coupled with the size restrictions at the Detroit-Windsor Tunnel, limits commercial vehicle usage. This corridor also serves as a transit route with frequent bus stops that effectively limit the flow of traffic in the right lane.
- **Wyandotte Street and Tecumseh Road** – These major arterial roads provide east-west access through the Windsor downtown. The two routes serve as key access facilities to the CBD for traffic traveling to/from the eastern regions of Windsor, where a majority of industrial plants servicing the automotive industry are located (Ford engine, Chrysler mini-van, and General Motors transmission plants).

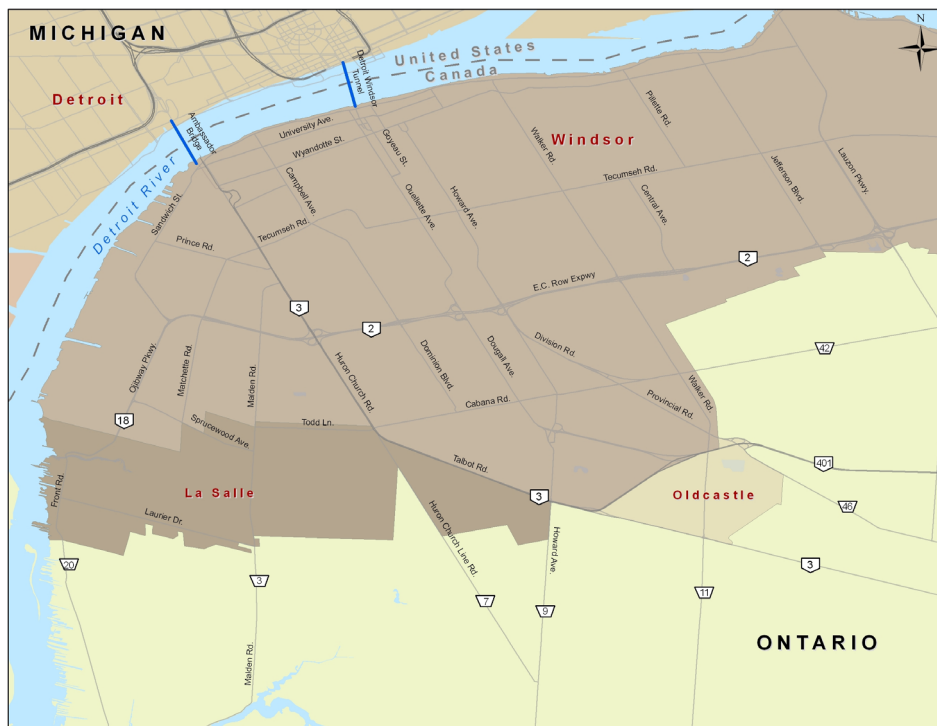

Figure 2-2. Existing Windsor Transportation Network

The major routes in the Port Huron region, as shown in **Figure 2-3**, include:

- **Interstate 69 (I-69)** – Provides the Port Huron region with east-west access to the rest of Michigan Lower Peninsula. The facility travels east-west and eventually turns north-south in Lansing to intersect with I-94 to the east of Battle Creek;
- **Interstate 94 (I-94)** – Connects Port Huron directly with the Detroit region to the south, and provides east-west access to southwestern Michigan and beyond.
- **Pine Grove Road (M-25)** – Provides a diagonal northwest/ southeast connection for local traffic accessing the Blue Water Bridge and I-94.
- **Pine Grove Connector (I-94BR)** – Provides a north-south connection from Pine Grove Road to the I-69/I-94BR, just north of the Blue Water Bridge.

The major routes in the Sarnia region, as shown in **Figure 2-3**, include:

- **Highway 402** – Provides a direct connection from the Blue Water Bridge to the rest of Canada as a four-lane freeway that links Sarnia with the rest of the Ontario, and eventually connects with Highway 401, approximately 100 kilometers (62.5 miles) to the southeast of Sarnia.
- **Front Street/Christina Street** – Provides the local north-south accessibility to the downtown and industrial regions in Sarnia. Front Street is closest to the bridge crossing and has ramp connections that accommodate all directions of traffic to/from the bridge, while the Christina Street ramps currently only accommodate traffic going to the bridge.



Figure 2-3. Existing Port Huron/Sarnia Transportation Network

DESCRIPTION OF EXISTING BORDER CROSSING FACILITIES

The bi-lateral trade between the United States and Canada is one of the largest in the world and the majority of the trade flows are concentrated at a few key border crossing locations. The border crossings in southeast Michigan and southwest Canada account for approximately one-third of the total bilateral trade between the United States and Canada and traverse three main crossings:

- Ambassador Bridge: located west of the tunnel and connecting southwest Detroit to western Windsor. This is directly connected to I-75 and I-96 and indirectly connected to I-94 on the U.S. side. The bridge is indirectly connected to Highway 401 via Huron Church Road and Talbot Road on the Canadian side;
- Blue Water Bridge: connecting Port Huron to Sarnia across the St. Clair River. This is directly connected to I-69 and I-94 on the U.S. side, and is directly connected to Highway 402 on the Canadian side ; and
- Detroit-Windsor Tunnel: connecting the Detroit and Windsor central business districts (CBDs) across the Detroit River and directly connects to the local streets on either side.

The existing three crossings have on-site toll collection plazas, customs and immigration facilities, and duty free stores to collect revenue, provide border security, and assistance to the traveling public. Two of the three facilities also have off-site secondary customs inspection facilities on the Canadian side of the border.

Detroit-Windsor Tunnel

The Detroit-Windsor Tunnel is an approximate 1.0 mile (1.6 kilometers) long submersed facility with a single lane in each direction, which connects the Detroit and Windsor central business districts, as shown in **Figure 2-4**. Access to the tunnel on the United States side is from Randolph Street that runs directly into the tunnel entrance or from East Jefferson Avenue that intersects with Randolph Street just prior to the tunnel entrance. A no-left turn restriction at the intersection of Randolph Street and East Jefferson Avenue for traffic traveling westbound along East Jefferson Avenue requires that this traffic go past Randolph Street, make a U-turn, and weave across four lanes along East Jefferson Avenue to make the right turn into the tunnel. The entrance to the tunnel has 5 toll booth plazas that collect cash or token tolls just prior to the entrance. Traffic then immediately merges into a single lane to enter the tunnel and maneuver through a 330 degree turn. The U.S.-bound traffic exiting the tunnel on the United States side is processed through 12 primary inspection booths and flows directly into the intersection of Randolph Street and East Jefferson Avenue. The secondary inspection site for commercial vehicles is limited but located adjacent to the primary inspection sites.

Access to Detroit-Windsor Tunnel on the Windsor side can occur from the north or from the south along Goyeau Street, between Park Street and Wyandotte Street East. The entrance to the tunnel has 6 toll booth plazas that collect cash or token tolls just prior to the entrance to the tunnel, and traffic then has to immediately merge into a single lane to enter the tunnel. The Canada-bound commercial vehicle traffic exiting the tunnel into Canada has the option to feed straight into Goyeau Street just before the intersection with Wyandotte Street East, where three primary inspection booths are available to process commercial vehicles. Alternatively, the commercial vehicles have the option to navigate through a 180 degree turn along with the passenger vehicles that accesses 9 primary inspection booths (only left-most lane for commercial vehicle processing), beyond which traffic has the option to turn right or left onto Park Street to go east or west, respectively. The secondary inspection site for commercial vehicles is located at Hanna Street south of the tunnel.

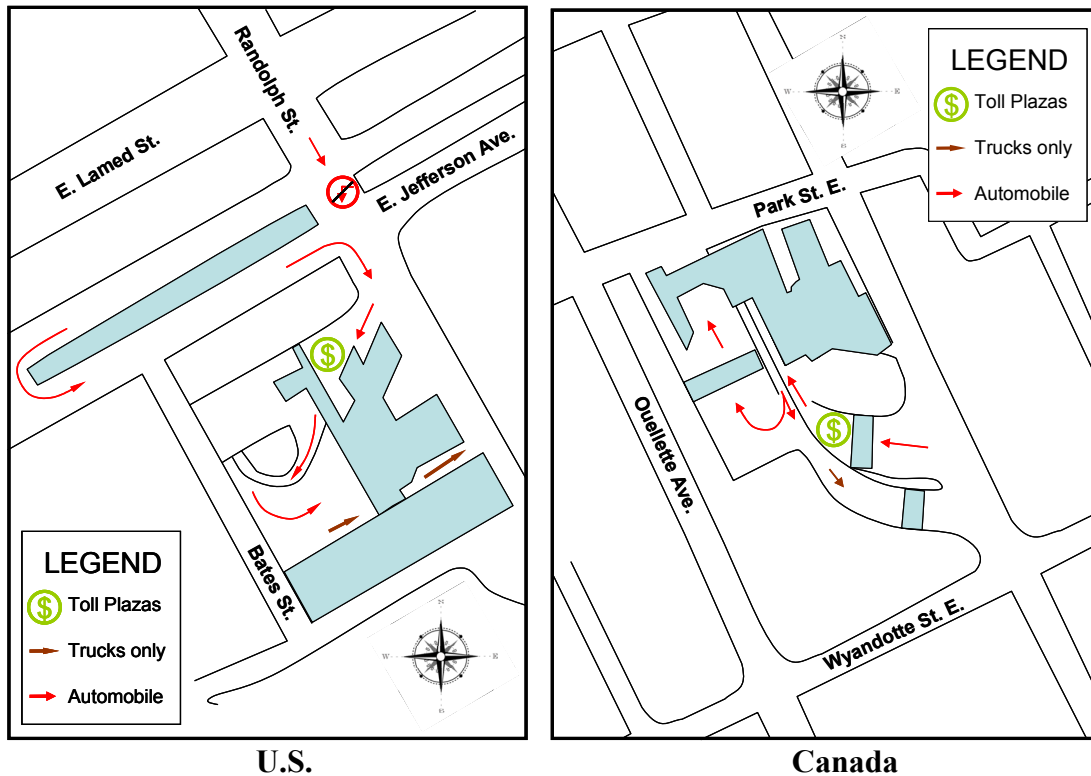
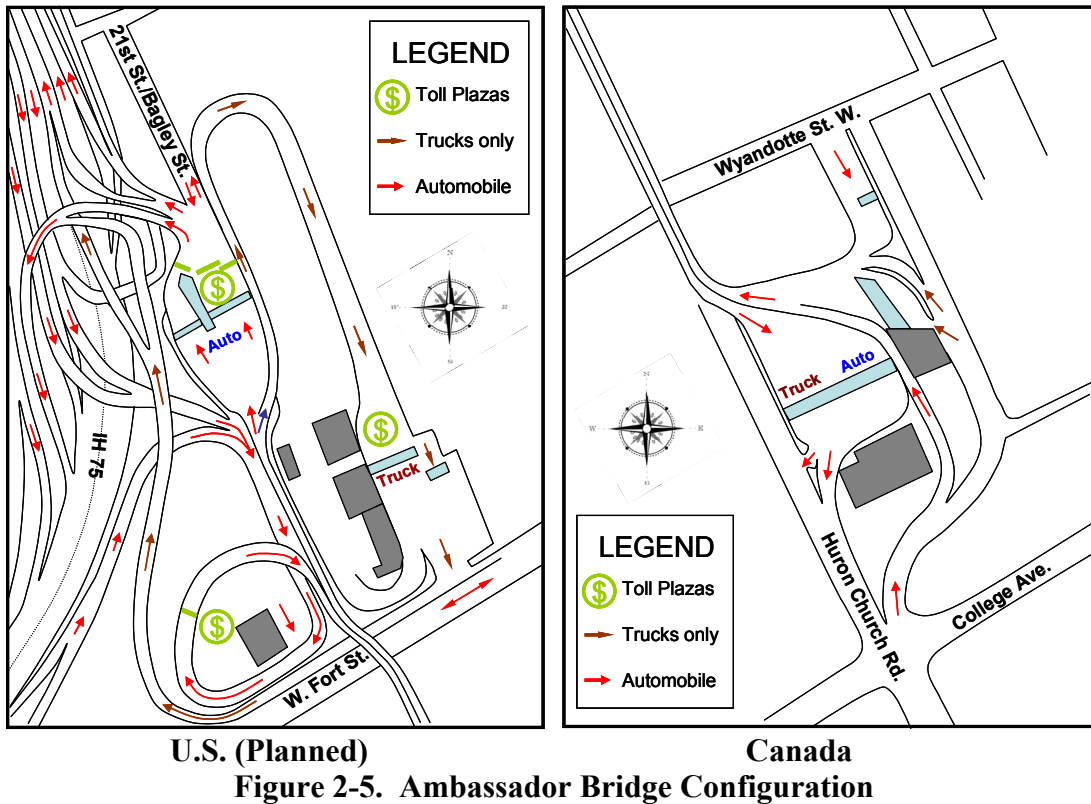

Figure 2-4. Detroit-Windsor Tunnel Configuration

Ambassador Bridge

The Ambassador Bridge is approximately 1.8 miles (2.8 kilometers) long from entrance to exit, and has two lanes in each direction. The construction of Ambassador Bridge plaza improvements on the U.S. side was underway as this study was conducted. The description herein of the Ambassador Bridge access on the U.S. side reflects the planned “full-build” of the designed plaza improvements. Direct access to the bridge on the United States side is provided from both southbound I-96 and I-75 mainlanes with 10 toll plaza booths, just before the entrance to the bridge, as shown in **Figure 2-5**. The northbound I-75 traffic can access the bridge by using the Clark Street exit ramp to travel along the service road and through seven toll plaza booths located just before the bridge entrance. The exit to the bridge on the United States side funnels automobile traffic through 12 primary inspection booths, and then through 12 toll booth plazas immediately after the immigration inspection booths. The automobile traffic can then proceed to enter westbound I-96, northbound I-75, southbound I-75, or the Detroit street grid thereafter. The commercial vehicle traffic is funneled through separated lanes to the east of the bridge to a truck exclusive designated customs and immigration inspection site that has nine primary inspection booths. The commercial vehicle secondary inspection facilities are located right next to the primary inspection site. Upon clearing the inspection booths, the trucks are then directed through nine toll booths and funneled onto the direct ramps to westbound I-96, southbound I-75, and northbound I-75. No direct access to the Detroit

street grid is permitted for commercial vehicles. Access to Ambassador Bridge on the Windsor side can occur from the south along Huron Church Road or from the north off of Wyandotte Street West. The exiting traffic from the bridge on the Canadian side has 10 automobile and 10 truck primary inspection plazas. The traffic leaving the inspection point can then proceed north or south along Huron Church Road. The commercial vehicle secondary site is located further south along Huron Church Road at Malden Road.



Blue Water Bridge

The Blue Water Bridge is approximately 1.2 miles (1.9 kilometers) long from entrance to exit, and has a three-lane dedicated bridge span for each direction. Direct access to the Blue Water Bridge on the United States side is from the four-lane east-west link of Interstate 69/94 that terminates at the bridge, as shown in **Figure 2-6**. The westbound automobile traffic from Canada is processed by 8 primary inspection booths, and commercial vehicles must stay in the leftmost lane and are processed by 5 dedicated primary inspection booths. Upon exiting the inspection booths, commercial vehicles re-merge with the automobile traffic. From here, the general traffic can travel northbound along the I-94/Pine Grove Connector or west/southbound along 1-69/I-94. The Canada-bound traffic has direct access from eastbound/northbound I-69/I-94, whereas the southbound traffic and local northbound traffic from Port Huron must use the Pine Grove

Road to access the bridge. The traffic from I-69/I-94 and Pine Grove Road merge just before 5 toll booth plazas and re-merges onto the three lane bridge span toward Canada.

Access to Blue Water Bridge on the Sarnia side can occur from the south along Highway 402 or from the east off of St. Clair Street. The U.S.-bound traffic passes through 6 toll booths prior to entering the bridge. The exiting traffic from the bridge on the Canadian side has 12 automobile and 8 truck primary inspection plazas. The traffic leaving the inspection point can then proceed south along Highway 402 or north along Venetian Boulevard via Marina Road. The commercial vehicle secondary site is located on-site, just south of the primary inspection site.

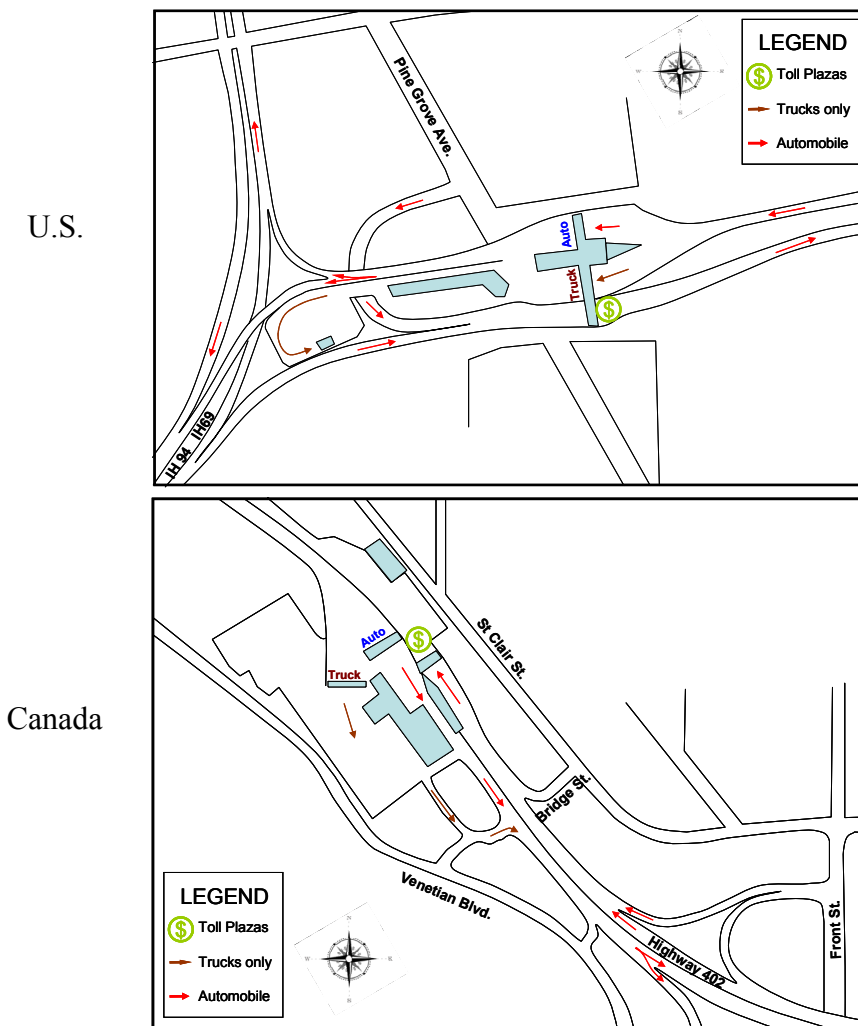

Figure 2-6. Blue Water Bridge Configuration

HISTORICAL BORDER TRAFFIC GROWTH TRENDS

The Public Border Operators Association (PBOA – formally known as Bridge and Tunnel Operators Association) has been recording the annual average monthly traffic volumes of several major border crossings in the north east between the United States and Canada since the 1970’s. The three combined Southeast Michigan/Southwest Ontario crossings in 2009 captured 14.98 million two-way border crossing traffic (45.4 percent of overall PBOA tracked vehicular traffic), and 3.70 million two-way commercial vehicular traffic (62.2 percent of the overall PBOA tracked commercial border crossing traffic). According to the PBOA, the Ambassador Bridge currently carries the highest commercial vehicle traffic of all border crossings tracked by PBOA between the United States and Canada, as shown in **Figure 2-7**. The Ambassador Bridge, Detroit-Windsor Tunnel, and Blue Water Bridge are among the five busiest PBOA monitored passenger vehicle crossings between the United States and Canada.

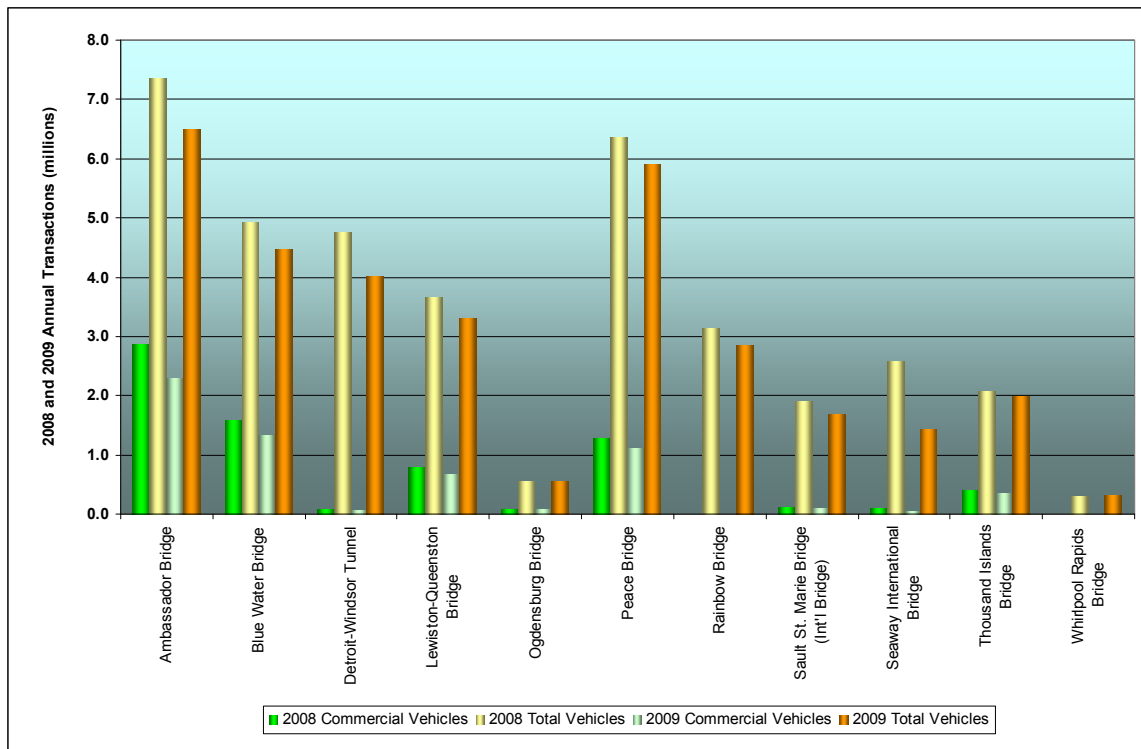
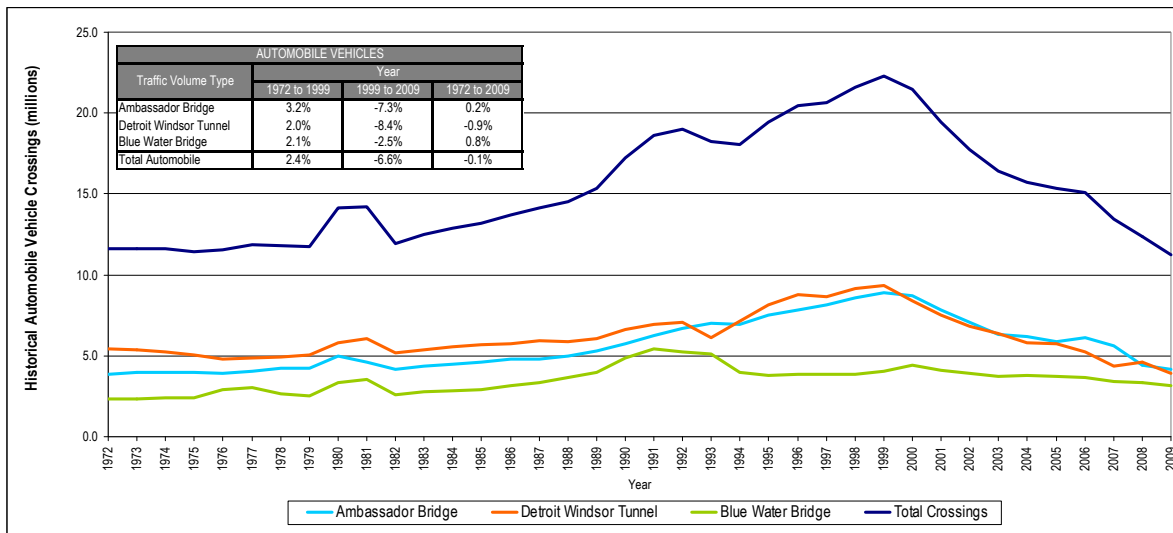

Figure 2-7. United States – Canada PBOA Border Crossings (2008/2009)

The historical annual automobile vehicular traffic along the three crossings exhibited a steady increase in traffic between 1972 and 1999, as shown in **Figure 2-8**. The automobile traffic at the three crossings reached their highest volumes in 1999, and demonstrated an average annual growth of approximately 2.4 percent between 1972 and 1999. The Ambassador Bridge, during this same period, had an average annual traffic

growth of approximately 3.2 percent, while the remaining two crossings illustrated an average annual growth in automobile traffic of close to 2.0 percent. Since 1999, the traffic declined at an average rate of -6.6 percent, and the Detroit-Windsor Tunnel demonstrated the most significant average annual decline of -8.4 percent until 2009. The 2008/2009 increase in fuel prices, along with the economic and financial crisis that the United States and the global economies have faced since 2007, may have contributed to the negative trend of the border crossing demand that has continued through 2009. The decrease in traffic volumes may also have been further exacerbated by the implementation of the Western Hemisphere Travel Initiative (WHTI) in June 2009, which required all U.S.-bound travelers to have a passport or an enhanced driver's license to clear the U.S. immigration.

The Detroit-Windsor Tunnel historically carried slightly higher shares of the overall passenger vehicle market, but has since the early 1990's been on par with the Ambassador Bridge. The long-term growth trends between 1972 and 2009 demonstrated that the Blue Water Bridge automobile traffic, while capturing a smaller share of the overall frontier automobile traffic market, experienced a 0.8 percent average annual growth between 1999 and 2009. The Detroit-Windsor Tunnel on the other hand experienced a negative average annual growth of -0.9 percent during the same period.



Note: Percentages in summary table reflect average annual compound growth.

Figure 2-8. Historical Annual Automobile Vehicle Crossings (1972-2009)

The historical annual commercial vehicular traffic along the three crossings increased significantly between 1972 and 1999, as shown in **Figure 2-9**. The commercial vehicle traffic at the three crossings plateaued in 1999 and demonstrated an average annual growth of approximately 5.6 percent between 1972 and 1999. The Ambassador Bridge, during this same period, showed commercial vehicle average annual traffic growth of

approximately 5.9 percent, while the Blue Water Bridge illustrated an average annual growth in commercial vehicle traffic of close to 6.8 percent. Since 1999, the traffic plateaued with unprecedented declines occurring in 2008 and 2009. The Detroit-Windsor Tunnel experienced the greatest decline in commercial traffic between 1972 and 2009, with an average annual decline of -3.1 percent. The overall commercial vehicle market across the frontier experienced a positive average annual growth of 3.2 percent between 1972 and 2009, however, the average annual growth more recently between 1999 and 2009 was -3.2 percent annually. This drop-off in commercial vehicle traffic to a large extent is primarily a result of the sharp declines in commercial vehicle traffic that has occurred over the last two years at all three crossings.

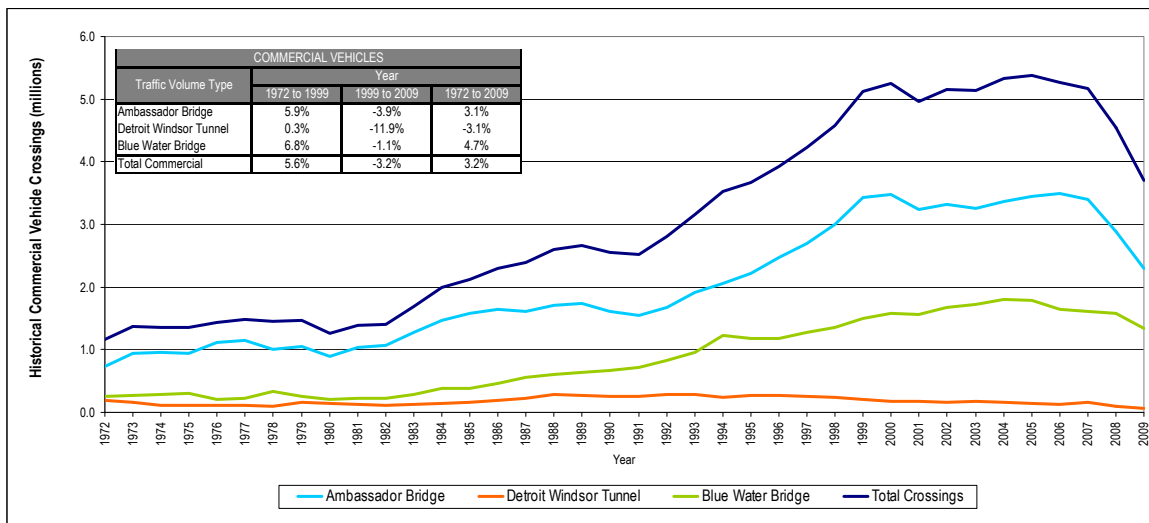

Note: Percentages in summary table reflect average annual compound growth.

Figure 2-9. Historical Annual Commercial Vehicle Crossings (1972-2009)

The Detroit-Windsor Tunnel historically handled the smallest share of commercial vehicles, due primarily to the physical and cargo constraints in place at the tunnel, and the accessibility constraints of the connecting roadways. The Ambassador Bridge has historically dominated the commercial vehicle market and has consistently carried almost double the commercial traffic crossing the Blue Water Bridge.

The historical annual total vehicular traffic for the three crossings exhibited significant increases in traffic between 1972 and 1999, as shown in **Figure 2-10**. The total vehicle traffic at the three crossings follows a similar trend to the automobile traffic, given the dominance of this overall market, with an average annual growth of approximately 2.9 percent for the 1972 to 1999 period. The Ambassador Bridge had the highest average annual growth of 3.8 percent for the total vehicles among the three crossings over this period, while the Detroit-Windsor Tunnel had the lowest average annual growth of 2.0 percent.

Consistent with the patterns established by automobile traffic, total traffic volumes at the three crossings since 1999 declined at a combined average annual rate of approximately -5.9 percent. The drop in total traffic volumes has been the greatest at the Detroit-Windsor Tunnel, declining at an average annual rate of approximately -8.4 percent, while the Blue Water Bridge exhibited the smallest rate of decline of -2.1 percent over the same period.

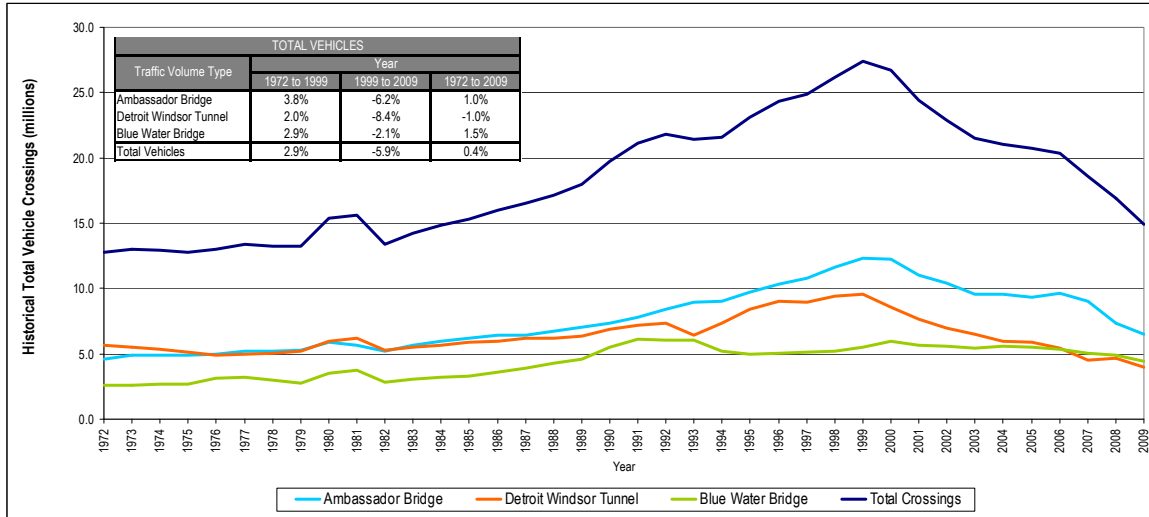

Note: Percentages in summary table reflect average annual compound growth.

Figure 2-10. Historical Annual Total Vehicle Crossings (1972-2009)

HISTORICAL BORDER CROSSING SEASONAL VARIATIONS

A look at the historical monthly data for automobile, commercial vehicles, and total traffic across the three crossings reveals that seasonal variations are somewhat different for each vehicle type and facility. The Ambassador Bridge seasonal variations, as shown in **Figure 2-11**, reveals that the automobile traffic peaks in the months of July/August, where traffic can be as much as 15 percent higher than the average. The lowest automobile volumes at the Ambassador Bridge typically occur during the months of September to February, where traffic has been shown to be consistently below the average by as much as 10 percent.

The commercial vehicle distribution shows a very different seasonal variation, with the peak months typically occurring in March and May, where the volumes are 10 percent higher than average volumes. The current 2009 trend shows the commercial vehicle monthly demand since August has been over 20 percent higher than the annual average trend which, to some extent, is a reflection of the low volumes that were captured in the early part of 2009. The low volume month over the last nine years has consistently been during July, when the commercial vehicle traffic drops by over 15 percent. The

automobile and commercial vehicle demand at the bridge showed very consistent seasonal variations over the last nine years.

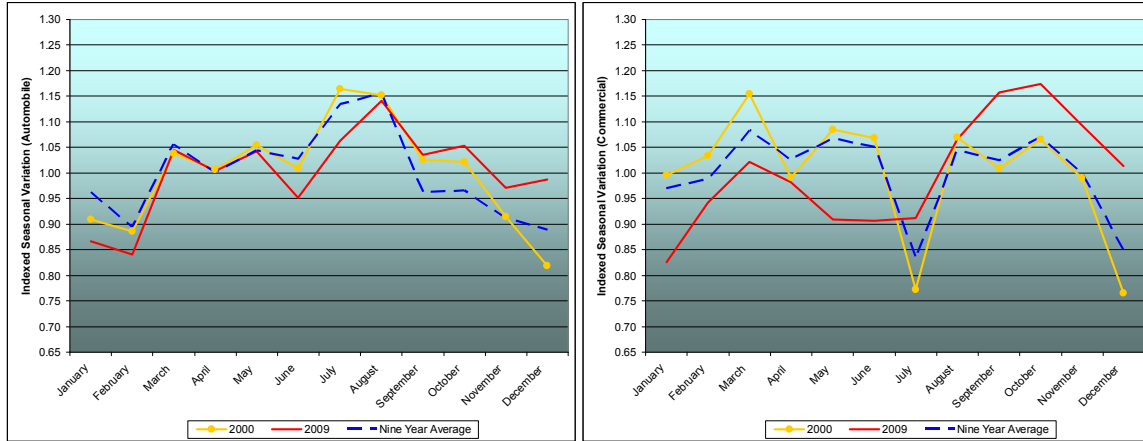

Figure 2-11. Ambassador Bridge Historical Seasonal Variations (2000-2009)

The Detroit-Windsor Tunnel seasonal variations, as shown in **Figure 2-12**, reveal that the automobile traffic variations were similar to the Ambassador Bridge and peaked in the months of July/August, where traffic can be as much as 5 percent higher than the average. The recent 2009 traffic data shows an atypical trend which most likely a result of the implementation of Western Hemisphere Travel Initiative (WHTI) that resulted in decreased traffic levels beginning in June. The effect of the initiative is evident at all the crossings, however, it appears to have had a more pronounced impact at the Tunnel. The low automobile volumes at the tunnel are typically during the months of September to February, when traffic was consistently below the average by as much as 5 to 10 percent.

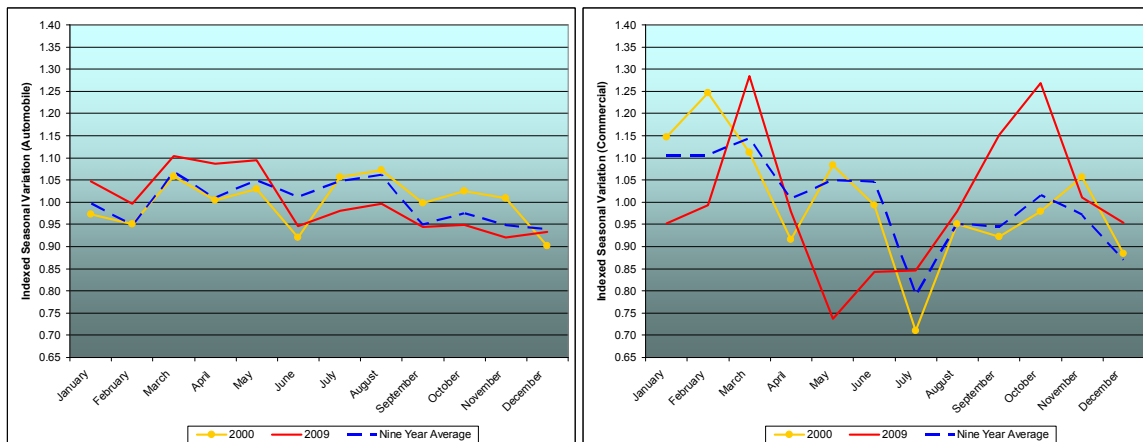

Figure 2-12. Detroit-Windsor Tunnel Historical Seasonal Variations (2000-2009)

The commercial vehicle distribution at the Detroit-Windsor Tunnel is volatile with seasonal variations that are sensitive to the automobile manufacturing industries. The peak months typically occur during March and May and are shown to be within the range of 10 percent higher than average volumes. The lowest-volume month over the last nine years has consistently been similar to the Ambassador Bridge and occurs during July, where the commercial vehicle traffic can drop by over 25 percent (this in part is a result of the automobile making industries’ model changeover period). The last nine years showed very consistent and stable seasonal variations for automobile traffic demand at the Detroit-Windsor Tunnel, while the commercial trends were more volatile given the low commercial vehicle demand.

The Blue Water Bridge seasonal variations, as shown in **Figure 2-13**, are similar to the Ambassador Bridge and Detroit-Windsor Tunnel. Automobile traffic peaks in the months of July and August, however, the magnitude of the variation is much more significant, with traffic varying by as much as 35 percent more than the average during these months. The low automobile volumes at the bridge are typically during the months of January and February, when traffic is consistently below the average by as much as 20 to 25 percent.

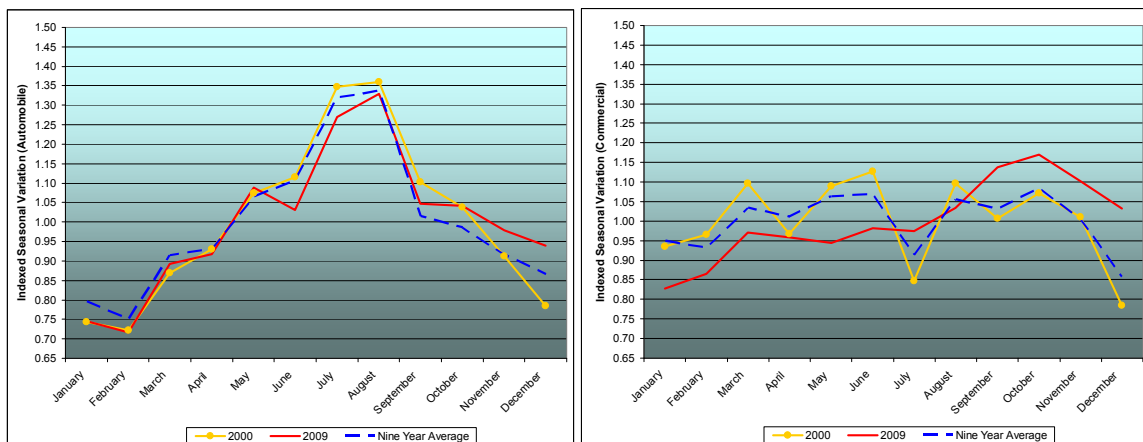

Figure 2-13. Blue Water Bridge Historical Seasonal Variations (2000-2009)

The commercial vehicle distribution at the Blue Water Bridge has very different seasonal variation to the automobile traffic with the peak months typically occurring during May and October, where traffic is close to 10 percent higher than the average volumes. The recent 2009 trends after August illustrate an increase of close to 20 percent in commercial vehicle demand compared to the annual average which, to some extent, reflects the low growth trends in the early part of the year. The lowest-volume month over the last nine years is similar to the other Detroit/Windsor crossings and has consistently been during July, where the commercial vehicle traffic drops by over 10 to 15 percent. The automobile and commercial vehicle demand at the Blue Water Bridge showed very consistent seasonal variations over the last nine years.

The total “frontier” (combined three crossings) seasonal variations, as shown in **Figure 2-14**, reveal that the automobile traffic demand peaks in the months of July and August, with traffic varying by as much as 15 percent more than the average during these months. The lowest automobile volumes across the “Frontier” are typically during the months of September and February, where traffic was consistently below the average by as much as 10 to 15 percent. The automobile 2009 trends for the most part follow a similar pattern to the nine year average with the exception of June, which to some extent reflects the implementation of the WHTI. The commercial vehicle 2009 trend shows a departure from the normal average trends with increased truck participation that appear to be occurring in the later months of 2009.

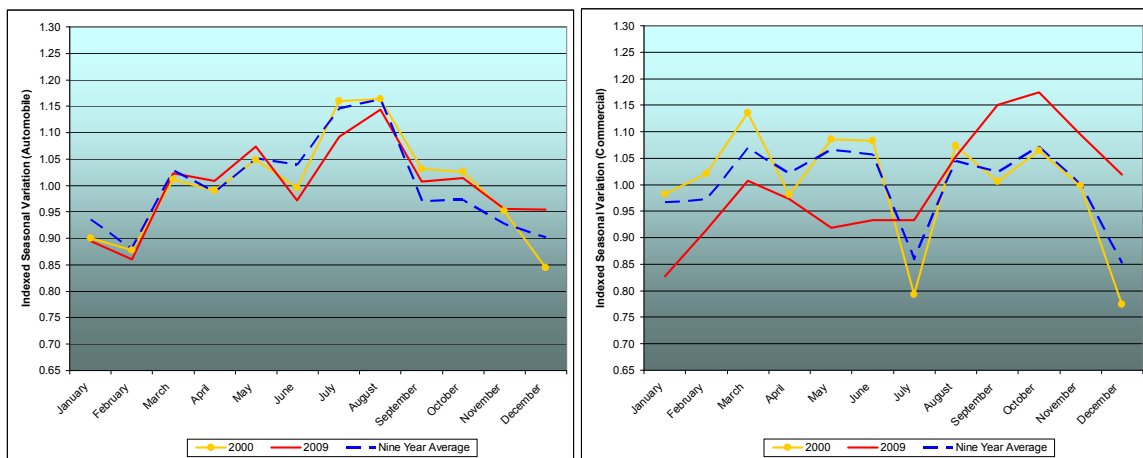

Figure 2-14. Total Frontier Crossing Historical Seasonal Variations (2000-2009)

The commercial vehicle distribution for the frontier exhibited very different seasonal variation to the automobile traffic markets, with the peak months typically occurring during March, May, and October, where commercial vehicle traffic is 10 percent higher than the average volumes.

Figure 2-15 provides a summary of the average nine year total seasonal variations across the three Southeastern Michigan/Southwestern Ontario border crossings. The Blue Water Bridge showed the highest variation between its peak and low volumes compared to the average, while the Ambassador Bridge and Detroit-Windsor Tunnel showed very similar seasonal distributions with August being the highest peak month and December the lowest volume month.

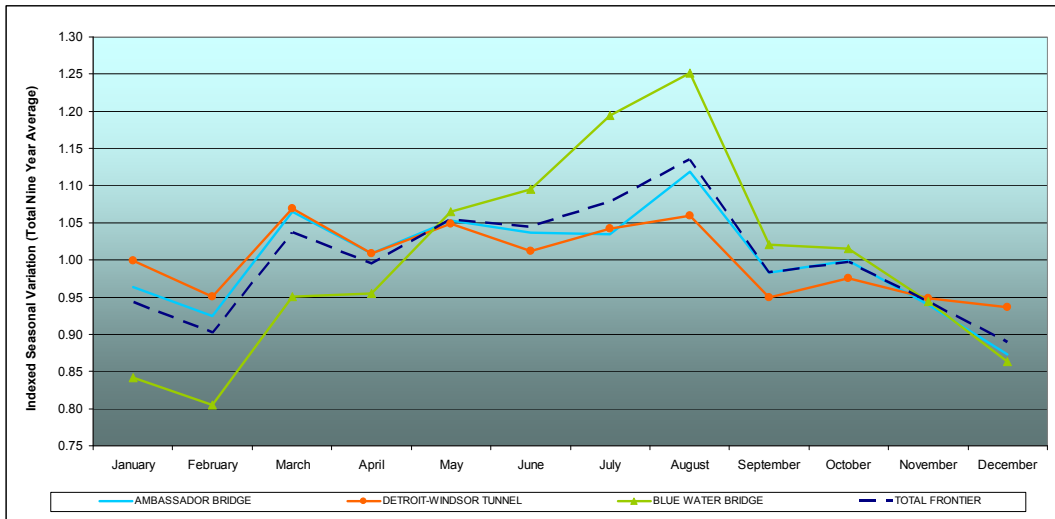

Figure 2-15. Nine-Year Average Seasonal Variations by Crossing (2000-2009)

HISTORICAL VEHICLE TYPE DISTRIBUTIONS

The following section summarizes the historical distribution of vehicles by major vehicle-type shares (passenger cars and commercial vehicles) using the border facilities within the Detroit/Windsor, and Port Huron/Sarnia regions.

The Ambassador Bridge commercial vehicle shares, as a percentage of the total Ambassador Bridge crossing traffic, have historically ranged between 20 and 40 percent, as shown by the annual monthly distributions in **Figure 2-16**.

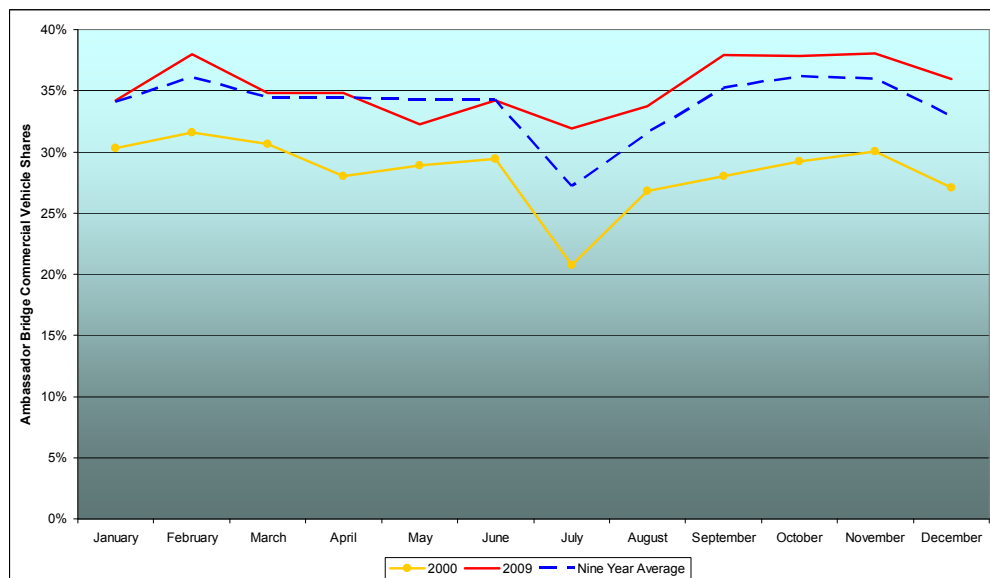

Figure 2-16. Ambassador Bridge Historical Commercial Vehicle Shares (2000-2009)

The average over the last nine years was approximately 35 percent over most months, with the exception of July and August when the shares decreased slightly below 30 percent. The 2009 distributions were very consistent with the nine-year average trends, with slightly higher overall shares occurring in the later months of 2009.

The commercial vehicle traffic at Detroit-Windsor Tunnel crossings have historically ranged between 1.5 and 2.5 percent, as shown in **Figure 2-17**. The average over the last nine years was just over 2.0 percent in most months, with the exception of July and August where the shares decreased. The 2009 commercial vehicle shares were lower than the nine-year average. This in part may be a result of the increase in overall automobile traffic diverted from the Ambassador Bridge Gateway construction project that began in 2008 and continued in 2009. The reduction in 2009 is also likely to be a result of the economic recession.

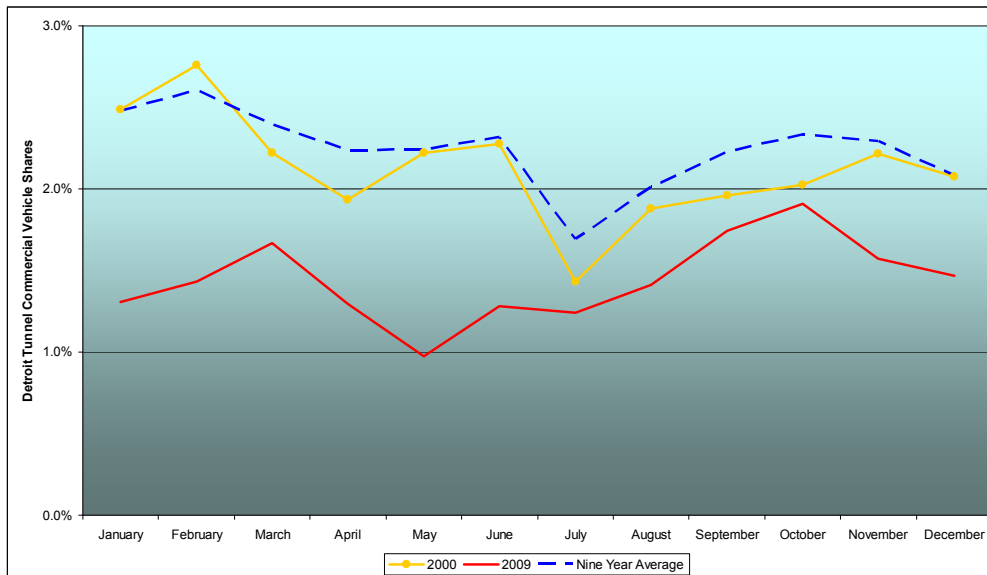

Figure 2-17. Detroit-Windsor Tunnel Historical Commercial Vehicle Shares (2000-2009)

The commercial vehicle traffic at the Blue Water Bridge crossings have historically ranged between 20 and 40 percent, as shown in **Figure 2-18**. The average over the last nine years has been approximately 30 to 35 percent over most months, with the exception of July and August, when the shares decreased. Overall, the commercial vehicle shares have remained fairly consistent at this crossing in 2009 compared to the nine-year average.

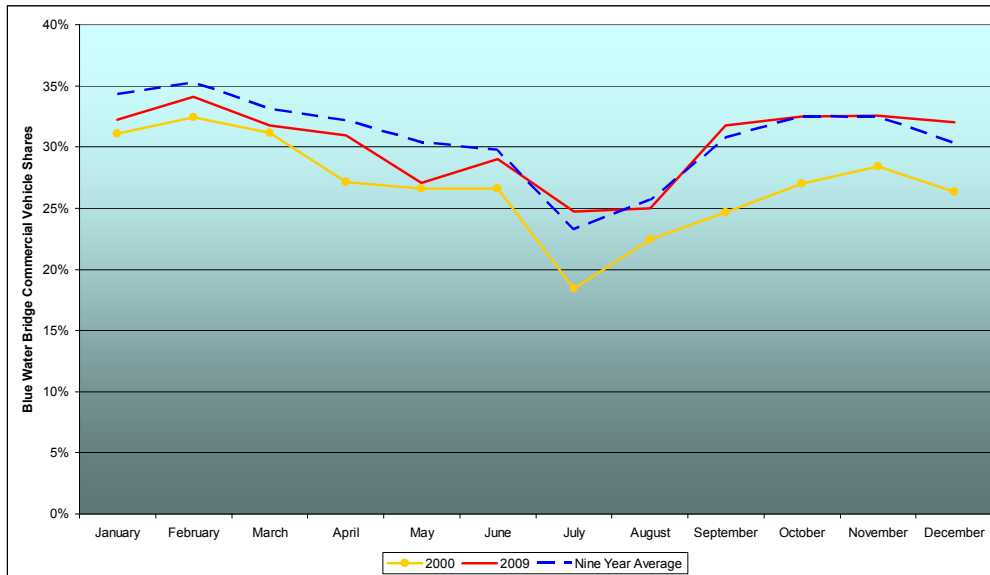

Figure 2-18. Blue Water Bridge Historical Commercial Vehicle Shares (2000-2009)

The total frontier commercial vehicle shares, as a percentage of the total crossings, have been shown to be consistently growing from 20 percent in 2000 to over 25 percent more recently, as shown in **Figure 2-19**. This increase in commercial vehicle share across the frontier in part is a result of the decline in passenger traffic that has been occurring since 1999. The nine-year average ranges between 20 and 25 percent with the lowest monthly share occurring in August.

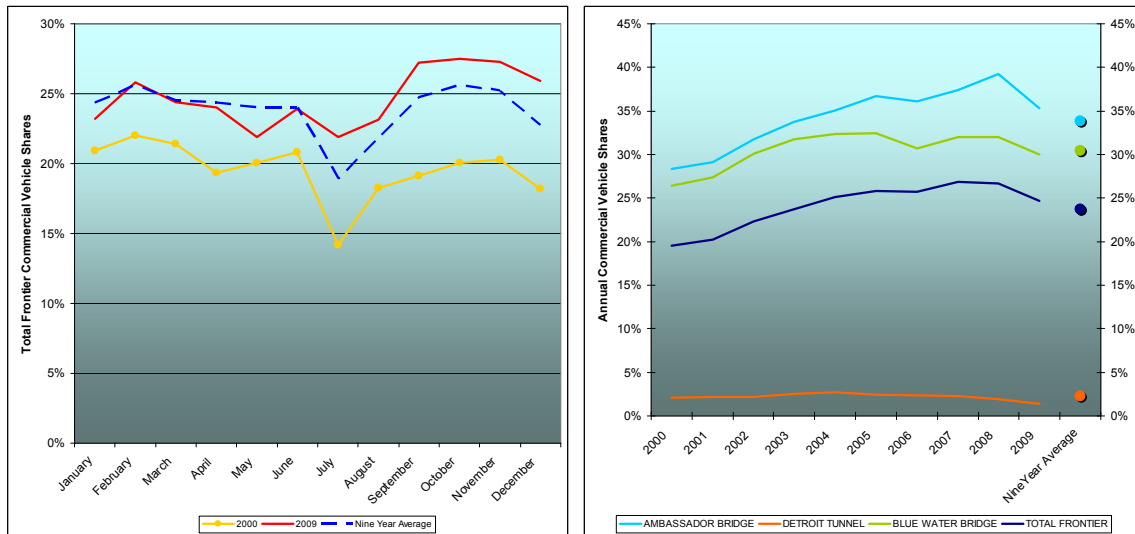

Figure 2-19. Total Historical Commercial Vehicle/Crossing Shares (2000-2009)

Figure 2-19 also illustrates the trends of the overall annual share of commercial vehicles over the last nine years for the respective crossings, and shows the Detroit-Windsor Tunnel commercial vehicle shares falling, while the share of the other two crossings were increasing until 2008, and have since then declined in 2009.

The total frontier vehicle shares for buses and miscellaneous vehicles have consistently been less than 1 percent of the overall traffic at all three crossings, as shown in **Figure 2-20**. The trends of the overall annual share of buses and miscellaneous vehicles over the last nine years for the respective crossings show that the share for this vehicle type market has more recently declined at the Ambassador Bridge and Blue Water Bridge and increased slightly at the Detroit-Windsor Tunnel.

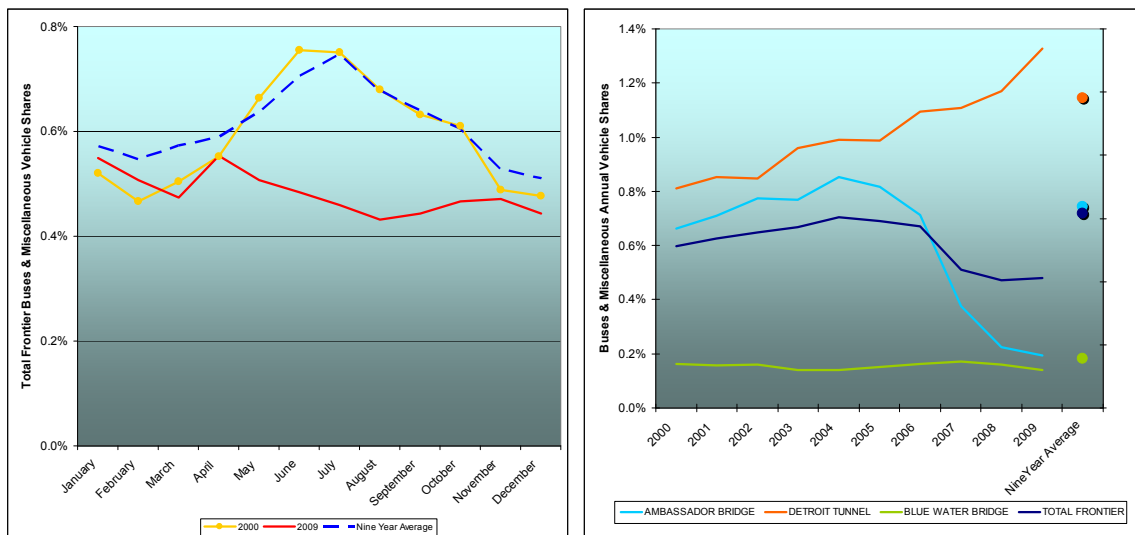

Figure 2-20. Historical Buses & Miscellaneous Vehicle/Crossing Shares (2000-2009)

HISTORICAL BORDER CROSSING CAPTURE SHARES

The following section summarizes the historical distribution and trends of the passenger and commercial vehicle border crossing shares across the facilities in the Detroit/Windsor and Port Huron/Sarnia regions.

Historically the Ambassador Bridge has, on average, captured approximately 40 percent of the three Detroit-Windsor-Port Huron-Sarnia total automobile border crossings traffic. This passenger vehicle share appeared to remain consistent throughout most months of the year with minimal fluctuations, as shown in **Figure 2-21**.

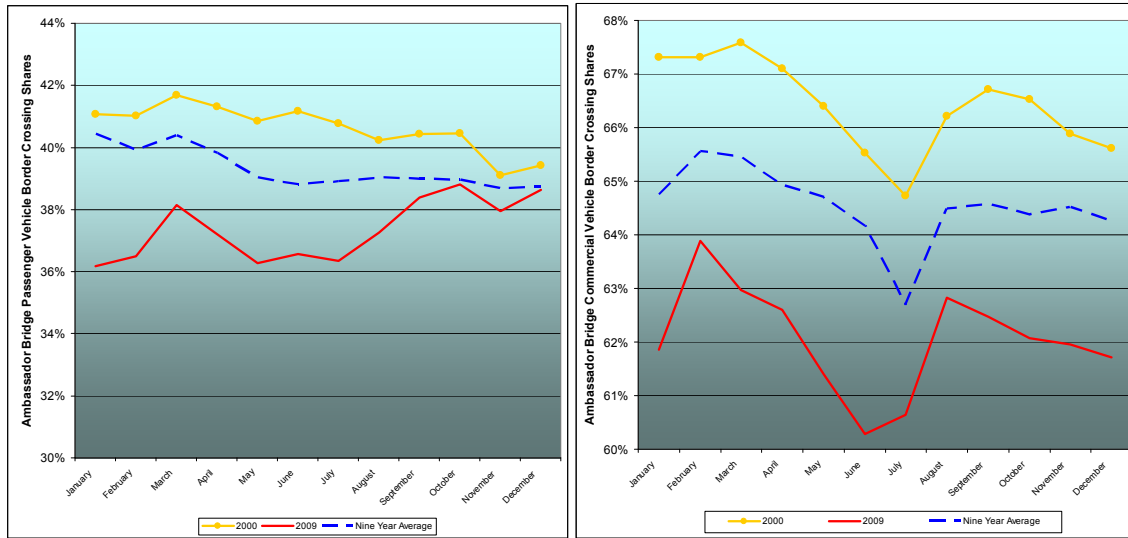

Figure 2-21. Ambassador Bridge Historical Crossing Capture Shares (2000-2009)

The 2009 commercial crossing share at the Ambassador Bridge remained slightly lower than the nine-year average for most of the year, even after the major completion of the Gateway construction project on the U.S. side. The commercial vehicle shares along the Ambassador Bridge historically captured between 60 and 70 percent of the overall commercial traffic across the frontier border crossings during the last nine years. The shares in 2009 were lower than the nine year average but followed a similar monthly variation.

Historically, the Detroit-Windsor Tunnel has, on average, captured a wide range of the automobile border crossing vehicular traffic that range between 30 percent and 40 percent of the total frontier traffic, as shown in **Figure 2-22**. The shares captured by the Detroit-Windsor Tunnel are lowest during the summer periods. This decrease in overall share is primarily due to the large influx of automobile traffic that the Ambassador Bridge captures during the July and August months, as shown in the seasonal variation section for the tunnel (see **Figure 2-12**). The commercial vehicle shares along the Detroit-Windsor Tunnel have historically captured between 2.0 and 3.0 percent of the overall commercial traffic across the frontier border crossings over the last nine years. The current 2009 trends show that the tunnel is currently capturing lower shares than the typical averages that have been exhibited over the past nine years.

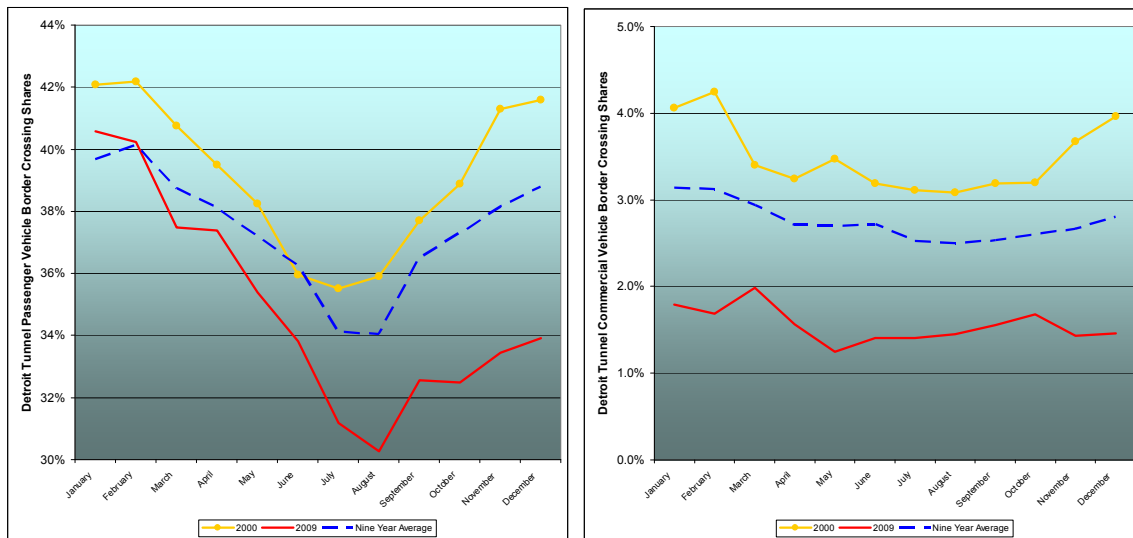

Figure 2-22. Detroit-Windsor Tunnel Historical Crossing Capture Shares (2000-2009)

Historically, the Blue Water Bridge has, on average, captured shares that range between 20 percent and 30 percent of the automobile border crossing vehicular traffic across the frontier, as shown in **Figure 2-23**. The shares captured by the Blue Water Bridge are highest during the summer periods, which is consistent with the higher traffic experienced at the bridge during the months of July and August. The commercial vehicle shares at the Blue Water Bridge have historically captured between 30 and 35 percent of the frontier commercial traffic over the last nine years. The 2009 shares for both automobile and commercial vehicle traffic at the Blue Water Bridge have increased compared to average trends, and this, in part, illustrates that the recessionary trends may have affected the Detroit border crossings to a larger extent than the Port Huron border crossing.

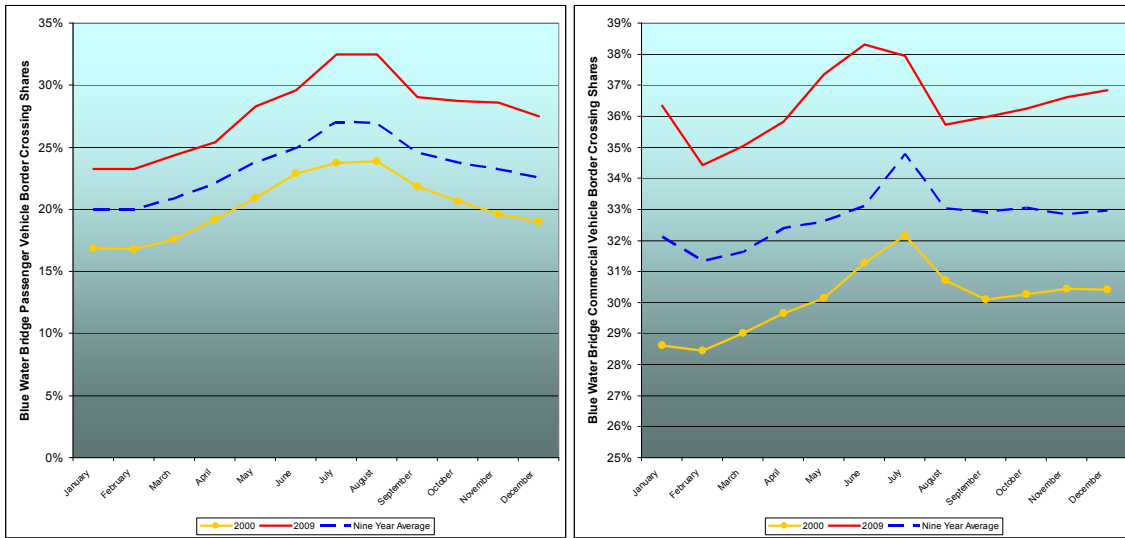

Figure 2-23. Blue Water Bridge Historical Crossing Capture Shares (2000-2009)

The overall annual captured shares for the automobile, commercial and total vehicles across the three border crossings are shown in **Figure 2-24**. The Blue Water Bridge passenger vehicle capture rates as a percentage of the total frontier passenger vehicle traffic have been consistently increasing over the last nine years, while the Detroit-Windsor Tunnel and Ambassador Bridge rates continue to fall. This, in part, may be due to the more rapid decline in traffic that was experienced within the Detroit/Windsor region compared to the Port Huron region.

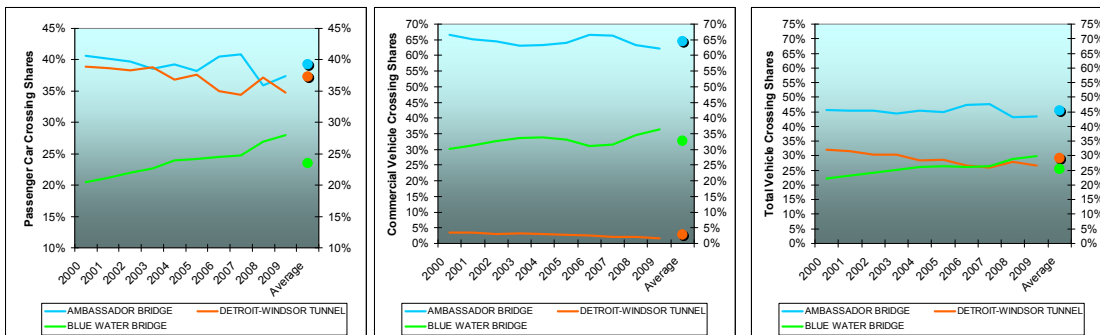

Figure 2-24. Historical Total Crossing Capture Shares Summary (2000-2009)

CHAPTER 3

TRAFFIC DATA COLLECTION AND ANALYSIS

The purpose of this chapter is to describe the comprehensive data collection effort that was undertaken as part of the proposed Detroit River International Crossing within the Windsor/Detroit/Port Huron/Sarnia region. The chapter describes the methodologies implemented for the traffic count collection, the origin-destination survey effort, and the stated preference survey effort. The key data and parameters generated as a result of these data collection efforts are then summarized. The data collection was developed to focus specifically on the travel demand markets currently using the Ambassador Bridge, the Detroit-Windsor Tunnel, and the Blue Water Bridge.

The data collection efforts were also designed to complement the previously performed data collection efforts that were undertaken as part of the Planning/Need and Feasibility (P/N&F) Study, the Detroit River International Crossing (DRIC-EIS) Study, and the 2008 comprehensive study undertaken for Transport Canada. General comparisons are provided between the new data collected and the previous studies to outline the significant temporal changes that have occurred since the previous studies.

The information contained in this section of the report outlines and summarizes:

- The Traffic Count Program;
- The Origin-Destination Survey efforts; and
- The Stated Preference Survey efforts.

TRAFFIC COUNT PROGRAM

A comprehensive traffic count program was conducted as part of the 2008 study along key screenline locations in Detroit/Windsor, Port Huron/Sarnia, and at the three international crossings of the Ambassador Bridge, the Detroit-Windsor Tunnel, and the Blue Water Bridge. These counts were also timed to occur in conjunction with the Origin and Destination (O-D) survey program undertaken as part of the Transport Canada 2008 comprehensive study. The traffic count program was structured to capture the current magnitude of traffic demand along the major roadways that provide access to the existing crossings, the commercial vehicle distributions, and the temporal and congestion characteristics typically experienced by the border crossing demand. As part of the 2008 traffic count program, two screenline count locations were selected on either side of the border in Detroit and Windsor, and along several key spot count locations to gauge the overall local demand along the facilities that were providing access to the international crossings.

The vehicle classification traffic volumes at the existing international crossings and their temporal profiles were captured using both automatic and manual vehicle classification counts to ensure that sufficient and reliable data was available to establish a baseline of the current conditions. These vehicle classification counts were carried out in accordance with the Federal Highway Administration (FHWA) vehicle classification system (13 vehicle class identification). Three reputable traffic count firms, Ontario Traffic Inc. in Canada, and Midwestern Consulting and MCV Inc. in the U.S., were selected to perform the traffic count collection. The following sections provide a detailed description of the 2008 and the refresh traffic count efforts that were undertaken. A summary of the results follows thereafter. The 2008 data collection undertaken as part of the Transport Canada comprehensive study included an extensive data collection effort to gain a good understanding of the overall regional traffic characteristics. As part of the refresh, the counts were recollected at selected key locations including the crossings to investigate any significant changes that may have occurred since the 2008 data collection efforts. Historical traffic count information was also collected to enhance the traffic profiling databases along key routes within the Detroit/Windsor region.

LOCAL TRAFFIC COUNT COLLECTION

During the initial development of the 2008 traffic count program, it was recognized that several significant construction projects on the Canadian and U.S. side were underway within the study area that would undoubtedly affected the normal distribution and characteristics of traffic along the major facilities within the Detroit/Windsor region. These projects made it difficult to obtain typical route specific demand profiles – therefore demand was evaluated on a screenline basis.

Detroit Region Traffic Counts – 2008 Collection Efforts

The accessibility to the existing international crossings on the Detroit side can occur via several major interstates and major roadways that include I-75, I-96, I-375, and M-10. The I-75 Ambassador Bridge Gateway Project was identified as a major construction project on the Detroit side during the 2008 study. This project began in February 2008, and involved the reconstruction of the interchange at I-75 and I-96, between Clark Street and Rosa Parks Boulevard on I-75, and Warren Avenue on I-96. While it was recognized that this construction, which was immediately north of the Ambassador Bridge, obviously impeded traffic, the bridge still maintained sufficient accessibility through local street detours. The 2008 traffic count program on the Detroit side therefore focused on obtaining the overall frontier demand characteristics from which to generate sufficient calibration information for use in the travel demand models.

The two screenlines identified to capture the traffic going to/from Detroit downtown, and the international trips traveling through the two existing Detroit River crossings included:

- Screenline 1: located south of I-96 to capture the total north-south traffic traveling towards the Detroit downtown area; and
- Screenline 2: located west of the Ambassador Bridge to capture the total east-west traffic traveling towards the Detroit downtown area.

A unique count number was assigned to each count location for purposes of identification and summary, as shown in the subsequent tables and figures. In order to understand the travel pattern of the commercial vehicle traffic, vehicle classification counts were collected at I-96, M-10, and I-75 for a continuous 48-hour period. **Table 3-1** illustrates the count locations and dates for the vehicle classification counts. These counts were important to get a sense of the overall truck traffic along the major facilities within the Detroit region, particularly in and around the existing Ambassador Bridge crossing.

Table 3-1 Vehicle Classification Counts in Detroit			
Count Number	Location Description	Duration (hours)	Collection Start Date
101/102	EB/WB I-75 West of Green Street	48	04/17/2008
103/104	NB/SB I-96 North of Buchanan Street	48	04/15/2008
105/106	NB/SB John C Lodge Freeway M10 at Warren Avenue	48	04/15/2008
107/108	NB/SB I-75 North of Canfield Street	48	04/16/2008

Screenline 1 was designed to capture the north/south directional traffic going to/from Detroit downtown and the international crossings. The screenline was located south of

Warren Avenue and extended from Livernois Avenue in the west, to Gratiot Avenue in the east. The fourteen (14) key traffic count locations along screenline 1 were identified as servicing the majority of the north-south traffic originating/destined to the Detroit downtown and the international crossing traffic, as shown in **Table 3-2**. These counts were all 48-hour counts that were collected during the middle of the week, to gauge the overall traffic characteristics along the identified routes. The traffic count collection along this screenline also enabled the study team to identify the high-volume local routes that serviced the local and border crossing demand. This information was then used to establish the current magnitude of traffic demand and the influence this demand had on the congestion characteristics along the major corridors providing access to the existing Ambassador Bridge and Detroit-Windsor Tunnel.

Table 3-2
Screenline 1 Traffic Volume Counts in Detroit

Count Number	Location Description	Duration (hours)	Collection Start Date
201	Livernois Avenue South of I-94	48	04/16/2008
202	W Grand Boulevard South of Warren Avenue	48	04/16/2008
203	Jeffries Freeway Service Road North of Buchanan Street	48	04/15/2008
204	Grand River Avenue South of Warren Avenue	48	04/16/2008
205	14 th Street South of Warren Avenue	48	04/16/2008
206	12 th Street South of Warren Avenue	48	04/16/2008
207	SB John C Lodge Service Road South of Warren Avenue	48	04/16/2008
208	NB John C Lodge Service Road South of Warren Avenue	48	04/16/2008
209	Woodward Avenue South of Warren Avenue	48	04/16/2008
210	SB Chrysler Drive South of Warren Avenue	48	04/16/2008
211	NB Chrysler Drive South of Warren Avenue	48	04/16/2008
212	Mt Elliot Street South of Warren Avenue	48	04/16/2008
213	E Grand Avenue South of Warren Avenue	48	04/16/2008
214	Gratiot Avenue South of Warren Avenue	48	04/16/2008

Screenline 2 was identified to capture the east/west movements between Michigan Avenue and Jefferson Avenue to/from the Detroit downtown area between Central Street and Green Street. A total of seven (7) count locations were identified along this screenline and included a vehicle classification count at I-75. The screenline traffic locations, also captured an additional spot count on Jefferson Avenue east of Sheridan Street (east of Detroit downtown), as shown in **Table 3-3**.

Table 3-3 Screenline 2 Traffic Volume Counts in Detroit			
Count Number	Location Description	Duration (hours)	Collection Start Date
301	Michigan Avenue East of Martin Street	48	04/15/2008
302	Dix Street East of Waterman Street	48	04/15/2008
303/304	WB/EB Fisher Freeway Service Road West of Green Street	48	04/15/2008
305	Fort Street West of Green Street	48	04/16/2008
306	Jefferson Avenue West of Green Street	48	04/15/2008
307	Jefferson Avenue East of Sheridan Street	48	04/15/2008

Figure 3-1 graphically illustrates the traffic count and screenline locations that were captured within the Detroit region as part of the 2008 study.



Figure 3-1. Detroit Region Traffic Count Locations

The traffic counts collected along the two screenlines showed that the I-75 (101/102) along the western section before the Ambassador Bridge carried approximately 73,000

vehicles in 2008, while the John C Lodge M10 (105/106) carried over 136,000 daily vehicles, as shown in **Figure 3-2**. The major north-south arterials along screenline 1 that carried over 25,000 daily vehicles included Livernois Avenue (201), Woodward Avenue (209), and Gratiot Avenue (214). The major east-west arterials carrying close to 20,000 daily vehicles included Michigan Avenue (301), Dix Street (302), and Jefferson Avenue (307).

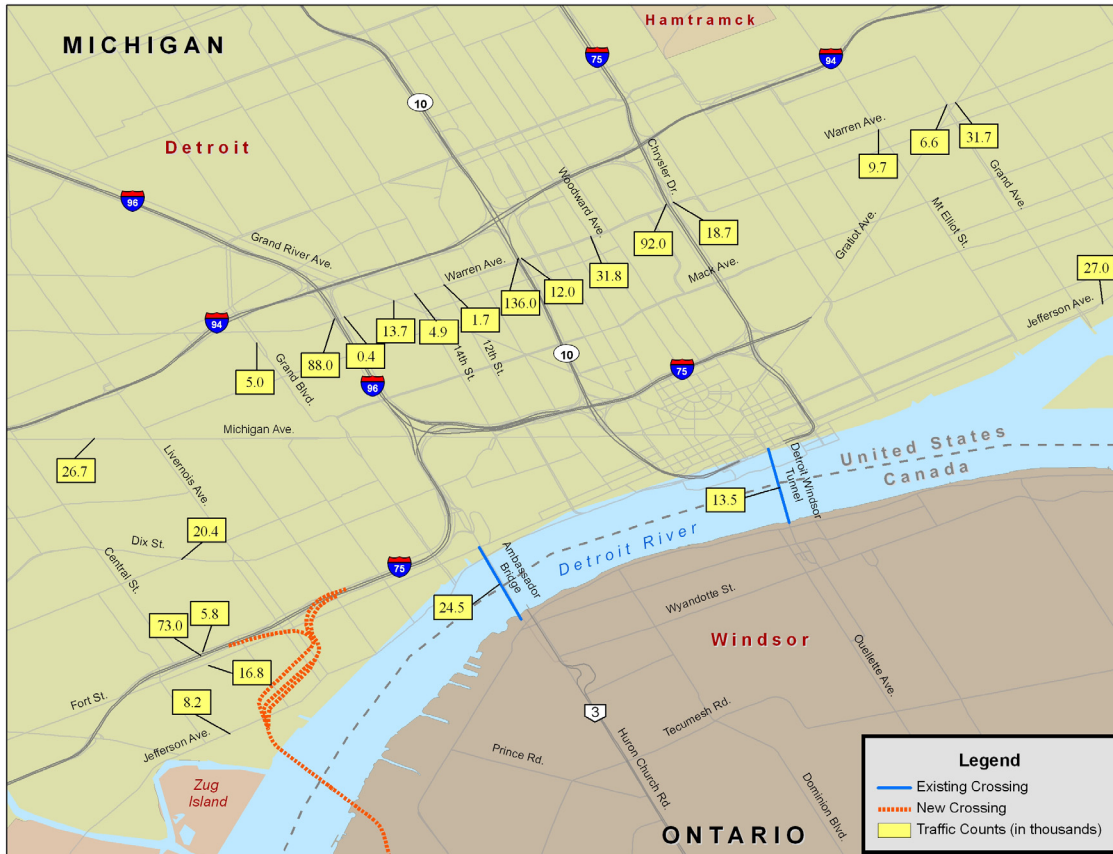

Figure 3-2. Detroit Region Traffic Count Summary (2008)

Analysis of the vehicle classification count data collected along some key highways within the Detroit region are shown in **Figure 3-3**. Truck traffic along the I-75 west of the Green Street location (101/102) was shown to account for over 15 percent of the overall traffic, with the eastbound truck volumes (over 8,000 average daily) far exceeding the westbound directional truck volumes (approximately 4,000 average daily) in 2008. This, in part, was a result of the aforementioned Gateway construction project at the Ambassador Bridge that was disrupting the patterns of traffic along the facilities accessing the existing crossings. The I-75 location west of the Ambassador Bridge was shown to carry a total directional truck volume of over 12,000 trucks in 2008. The total directional daily truck volumes along I-96 were approximately 4,900 while M-10 and I-

75 east of Detroit both carried less than 2,600 daily truck volumes and accounted for less than 5 percent of the overall daily traffic volumes.

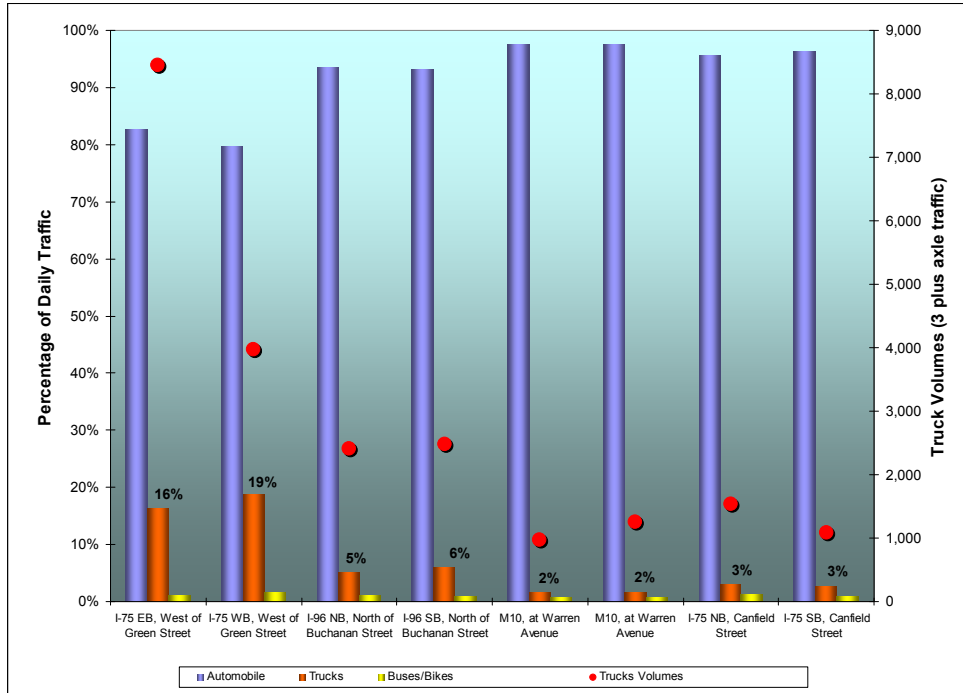

Figure 3-3. Detroit Region Truck Traffic Summary (2008)

Detroit Region Traffic Counts – 2009 Collection Efforts

The historical traffic databases maintained by the Michigan Department of Transportation for the major corridors within the Detroit region were used to evaluate the existing trends of auto and truck traffic along major facilities within the region. Ten site locations were identified along I-96, I-75, and I-696 to gauge the overall volume trends and traffic characteristics within the region and to measure the magnitude of overall growth that occurred since 2007. **Figure 3-4** provides a summary of the modal shares and bi-directional average monthly traffic volumes at the respective locations. The analysis showed that the daily truck traffic (Class 2 – single-unit commercial vehicles and Class 3 – single and multi-trailer commercial vehicles) has declined significantly along I-75 to the north of I-96 (10,170 less average daily trucks) and along I-696 just west of I-94 (17,900 less average daily trucks) between 2007 and 2009¹. Further review illustrates that the majority of the lost truck traffic consisted of the Class 2 (single-unit commercial vehicles) and occurred in October 2008, during the time when GM announced its plans for plant closures.

¹ Note: Summarized estimates were obtained from MDOT daily volumes that were averaged for each individual month and then averaged over the months to obtain an average annual daily volume estimate for each year, no seasonal adjustments are undertaken.

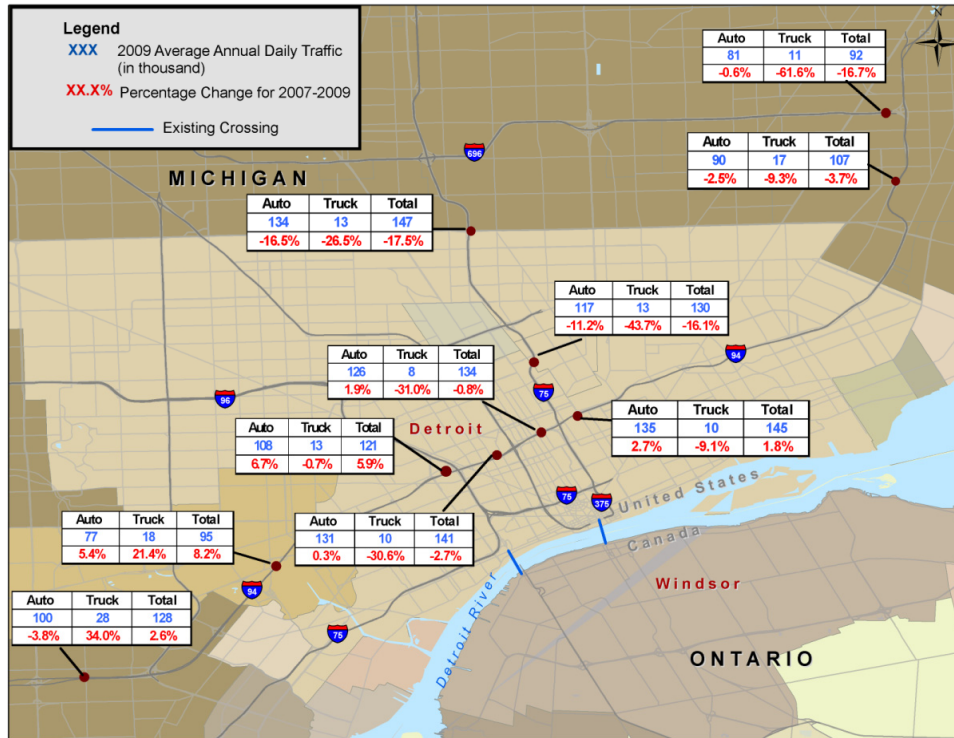

Figure 3-4. Detroit Region Historical Traffic Summary

Port Huron Region Traffic Counts – 2008 Collection Efforts

The Blue Water Bridge in the Port Huron region also acts as a competitor to the Detroit/Windsor international crossings, especially for the commercial and long distance travel markets. In order to understand the truck movements on the two main freeway routes within Port Huron, vehicle classification counts were conducted at I-69 and I-94, as illustrated in **Table 3-4** and **Figure 3-5**. The vehicle classification counts were established to gauge the magnitude of the commercial vehicle traffic destined to the western regions along I-69 and the southern regions along I-94.

Table 3-4
Vehicle Classification Counts in Port Huron

Count Number	Location Description	Duration (hours)	Collection Start Date
401/402	EB/WB I-69 West of N Range Road	48	04/22/2008
403/404	NB/SB I-94 South of Griswold Road	48	04/22/2008



Figure 3-5. Port Huron Region Traffic Count Locations

The traffic counts collected at the Port Huron locations, as summarized in Figure 3-6, showed that the I-94 (403/404) carried a more significant volume compared to the I-69 (401/402).



Figure 3-6. Port Huron Region Traffic Count Summary (2008)

A review of the truck traffic volumes at these two locations, as summarized in **Figure 3-7**, shows that while the I-69 carries significantly less overall daily traffic, it carries a larger proportion of truck traffic compared to the I-94. The percentage of truck traffic along I-69 is over 20 percent, while the truck traffic along I-94 within the vicinity accounted for 10 percent of the overall daily traffic. The total directional daily truck volumes along I-69 captured approximately 3,800 daily trucks and 3,000 daily trucks along I-94 in 2008.

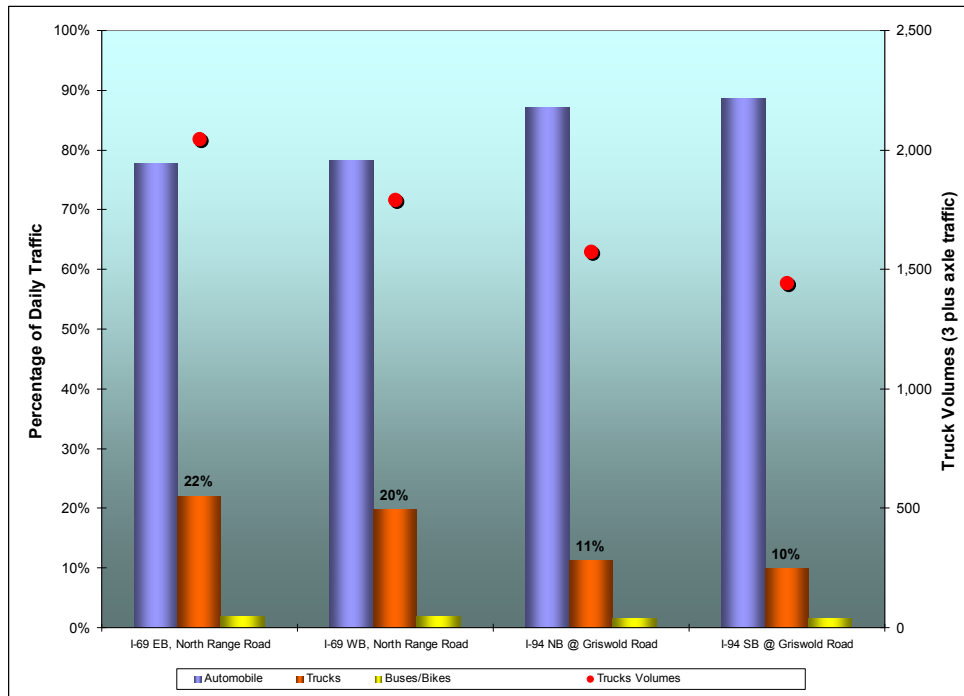

Figure 3-7. Port Huron Region Truck Traffic Summary (2008)

Port Huron Region Traffic Counts – 2009 Collection Efforts

A recount was undertaken at the same locations as the 2008 traffic count collection in order to gauge the differences in the truck movements along the two main freeway routes within Port Huron. The vehicle classification counts were conducted at I-69 and I-94, as illustrated in **Table 3-4** and **Figure 3-4** in November 2009. The new vehicle classification counts were also undertaken to identify any significant changes in truck traffic destined to the western regions along I-69 and the southern regions along I-94. **Figure 3-8** provides a summary of the new truck traffic volume counts at the two locations, and illustrated that the patterns did not change significantly from the 2008 patterns. The I-69 corridor continues to carry significantly less overall daily traffic with a higher proportion of truck traffic (over 20 percent) compared to the I-94 (10 percent). The westbound truck traffic along the I-69 was shown to have declined slightly compared to the 2008 counts. The 2009 captured total directional daily truck volumes along I-69

were approximately 3,360 daily trucks and 2,810 daily trucks along I-94. Both were close to previous 2008 truck volume counts at these locations.

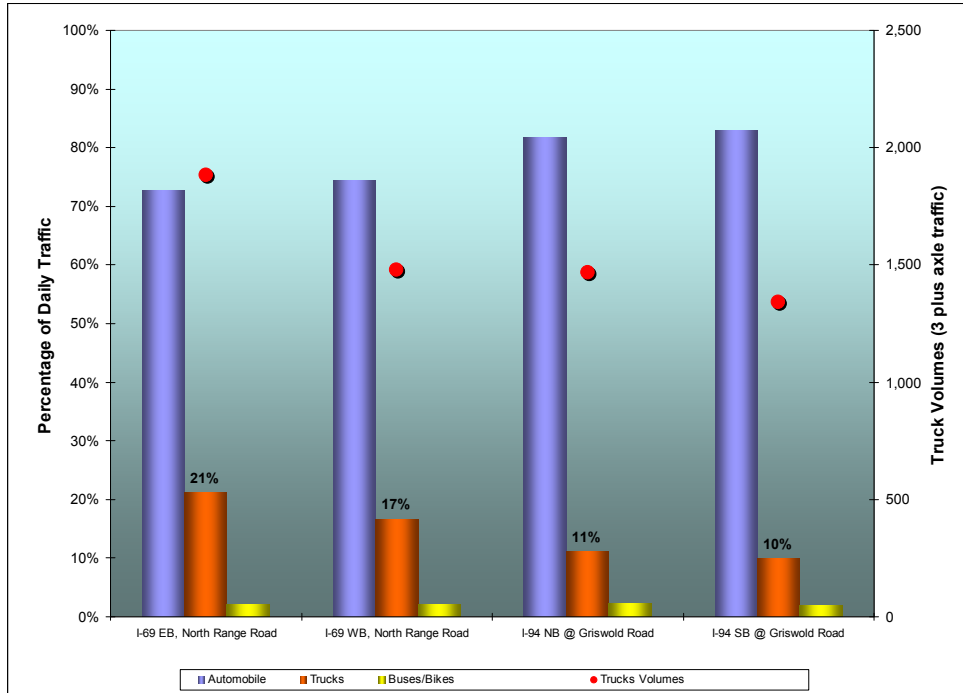

Figure 3-8. Port Huron Region Truck Traffic Summary (2009)

Windsor Region Traffic Counts – 2008 Collection Efforts

The accessibility on the Windsor side of the international crossing consists of several major arterials that included Huron Church Road, Highway 401, Highway 2 (E.C. Row Expressway), and Ojibway Parkway. Several major construction projects within Windsor were underway during the traffic count collection in April 2008, which included:

- Dougall Avenue closures between Highway 401 and Sixth Concession Road;
- Walker Road closures for through-traffic between St. Julien Avenue and Parkdale Place/Grand Marais Road; and
- Highway 401 was under construction between Highway 3 and Manning Road with both eastbound and westbound reduced to one lane in each direction from the regular two lanes in each direction.

These construction projects affected the normal travel pattern in the Windsor area and, therefore, the focus of the data collection was to gain a better understanding of the overall traffic demand and its temporal distribution. A review of the traffic distributional changes

and follow-up discussions with local Windsor contacts revealed that the long-distance traffic was observed to divert to Highway 2 (E.C. Row Expressway) and Tecumseh Road to avoid the construction on both Dougall Avenue and Highway 401. The closure of Walker Road also diverted traffic to parallel routes on either side along Central Avenue, and Howard Avenue.

Two screenlines were defined to capture both north/south movements within the Windsor area and the long-distance east/west markets traveling into/out of Windsor.

- Screenline 3: located north of the Highway 2 (E.C. Row Expressway) and extending from Ojibway Parkway in the west, to Central Avenue in the east;
- Screenline 4: located east of the Windsor region to capture the east/west traffic movement into the Windsor region and extending from Tecumseh Road in the north, to Highway 3 in the south.

Screenline 3 was developed to capture the overall demand profile of traffic traveling north toward the two international crossings. It was selected to ensure that all traffic from the E.C. Row Expressway and Highway 401 were accounted for, and to measure the magnitude of traffic demand during the peak periods. A total of eight (8) locations were collected along this screenline as continuous 48-hour counts on April 15, 2008, as shown in **Table 3-5**.

Count Number	Location Description	Duration (hours)	Collection Start Date
501	Ojibway Parkway North of Highway 18	48	04/15/2008
502	Machette Road North of E.C. Row Expressway	48	04/15/2008
503	Malden Road North of E.C. Row Expressway	48	04/15/2008
504	Huron Church Road North of E.C. Row Expressway	48	04/15/2008
505	Dominion Boulevard North of Highway 2	48	04/15/2008
506	Dougall Avenue North of the Ramp to Highway 2	48	04/15/2008
507	Howard Avenue North of E.C. Row Expressway	48	04/15/2008
508	Central Avenue North of E.C. Row Expressway	48	04/15/2008

Screenline 4 was designed to capture the movement traveling into/out of the Windsor area from the east. The Ontario Ministry of Transportation (MTO) continuously monitors the traffic on Highway 401 in Windsor through a permanent vehicle classification traffic count detector located close to the County Road 17. The screenline was therefore

established to include this location, thus ensuring that this MTO data could be used in conjunction with the new data collected. The April 2008 vehicle classification counts were obtained from MTO as part of the Transport Canada 2008 comprehensive study. A description of the traffic count locations and dates are shown in **Table 3-6** and **Figure 3-9**.

Table 3-6 Screenline 4 Traffic Volume Counts in Windsor			
Count Number	Location Description	Duration (hours)	Collection Start Date
601	Tecumseh Road West of Banwell Road	48	04/15/2008
602/603	EB/WB E.C. Row Expressway West of Banwell Road	48	04/15/2008
604	Lauzon Parkway North of Service Road B	48	04/15/2008
605 ¹	Highway 401 West of County Road 17	48	04/15/2008
606	Highway 3 East of Sexton Sideroad	48	04/15/2008

¹ Traffic counts were obtained from Ontario Ministry of Transportation.

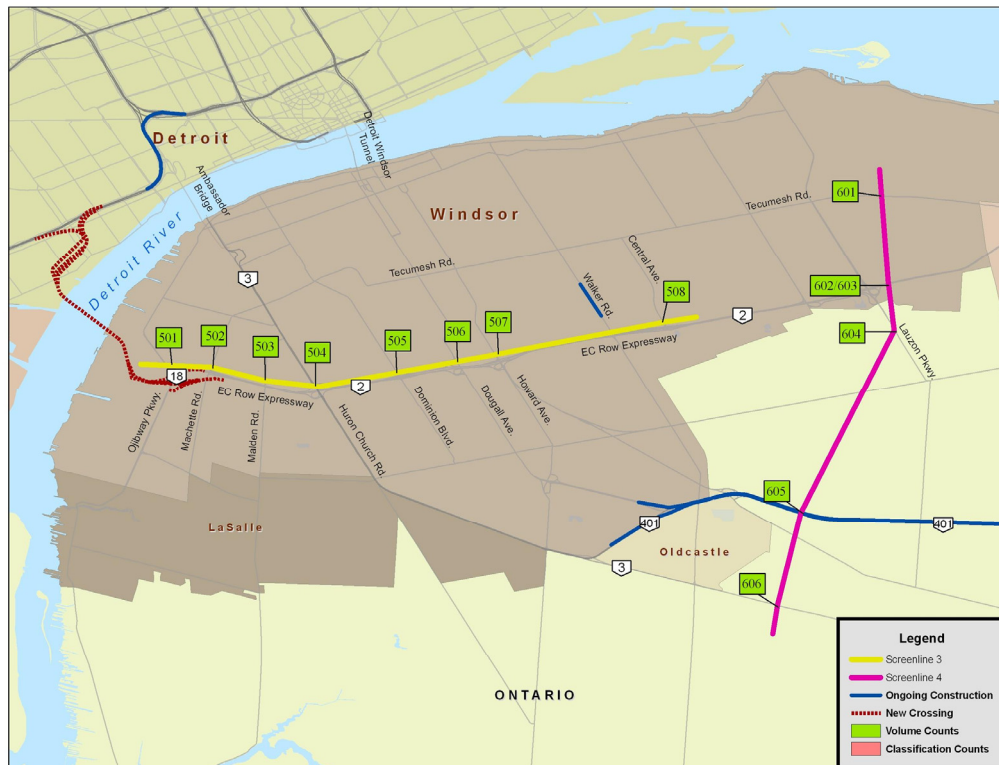

Figure 3-9. Windsor Region Traffic Count Locations

The counts collected along the two screenlines in the Windsor region, as summarized in **Figure 3-10**, show that Dougall Avenue (506), Howard Avenue (507), and Central Avenue (508) all carried significant traffic volumes of close to 50,000 daily vehicles. The construction along Walker Road diverted traffic to these three respective facilities, such that the typical volumes would be expected to be less than those captured as part of the traffic count program. Historical data was obtained to gauge the typical levels of traffic along these three routes and to quantify the magnitude of the diversion that must have occurred to each facility. The east-west traffic, to the east of Windsor, showed that the E.C. Row Expressway carried close to 45,000 daily vehicles, while the Highway 401 was found to capture 25,000 daily vehicles.

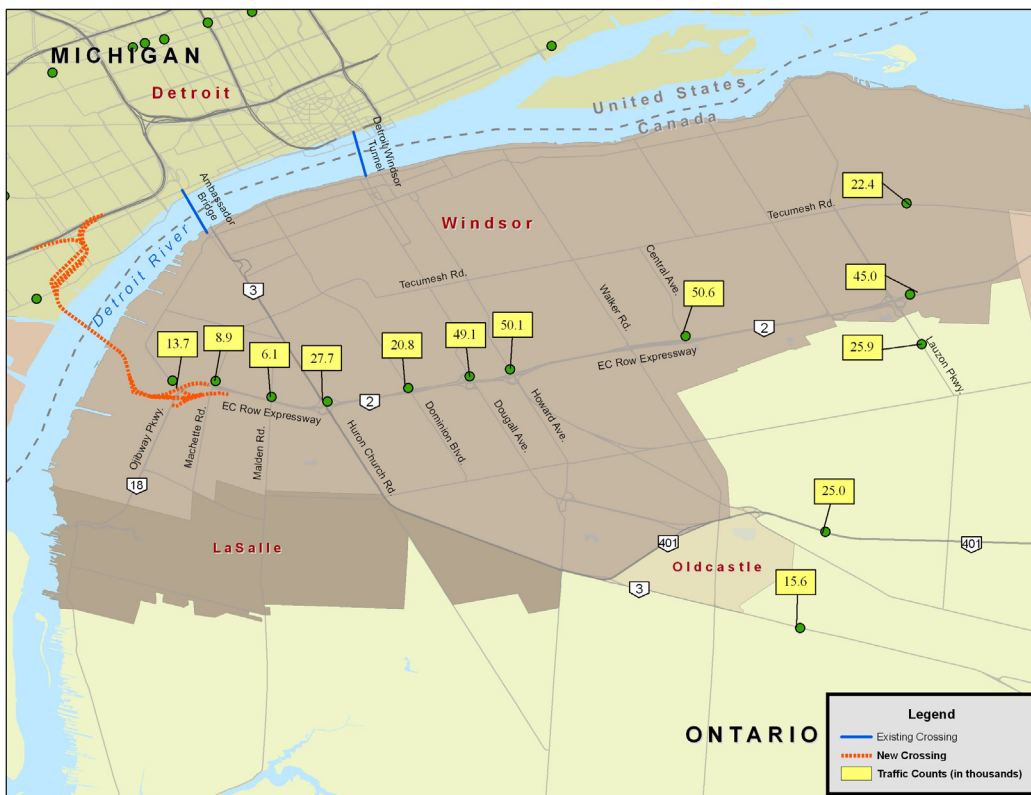

Figure 3-10. Windsor Region Traffic Count Summary (2008)

Windsor Region Traffic Counts – 2009 Collection Efforts

As part of the refresh study, additional 48-hour counts were collected on the Windsor side of the international crossing along Highway 2 (E.C. Row Expressway) west of Lauzon Parkway, and Huron Church Road, north of the E.C. Row Expressway. The counts collected in 2009, as illustrated in **Figure 3-11**, show that the traffic along E.C. Row has remained fairly consistent while the Huron Church Road traffic increased from the captured 2008 levels. The 2009 daily volumes along Huron Church Road increased

by 21 percent compared to 2008 volumes, and showed approximately 33,600 daily vehicles currently traveling along the facility north of E.C. Row Expressway. This in part may reflect the return of traffic that was previously diverted by the construction activities along Highway 401 during the 2008 count collection. The E.C. Row Expressway was shown to carry approximately 44,800 daily vehicles, which was consistent with collected counts in 2008.

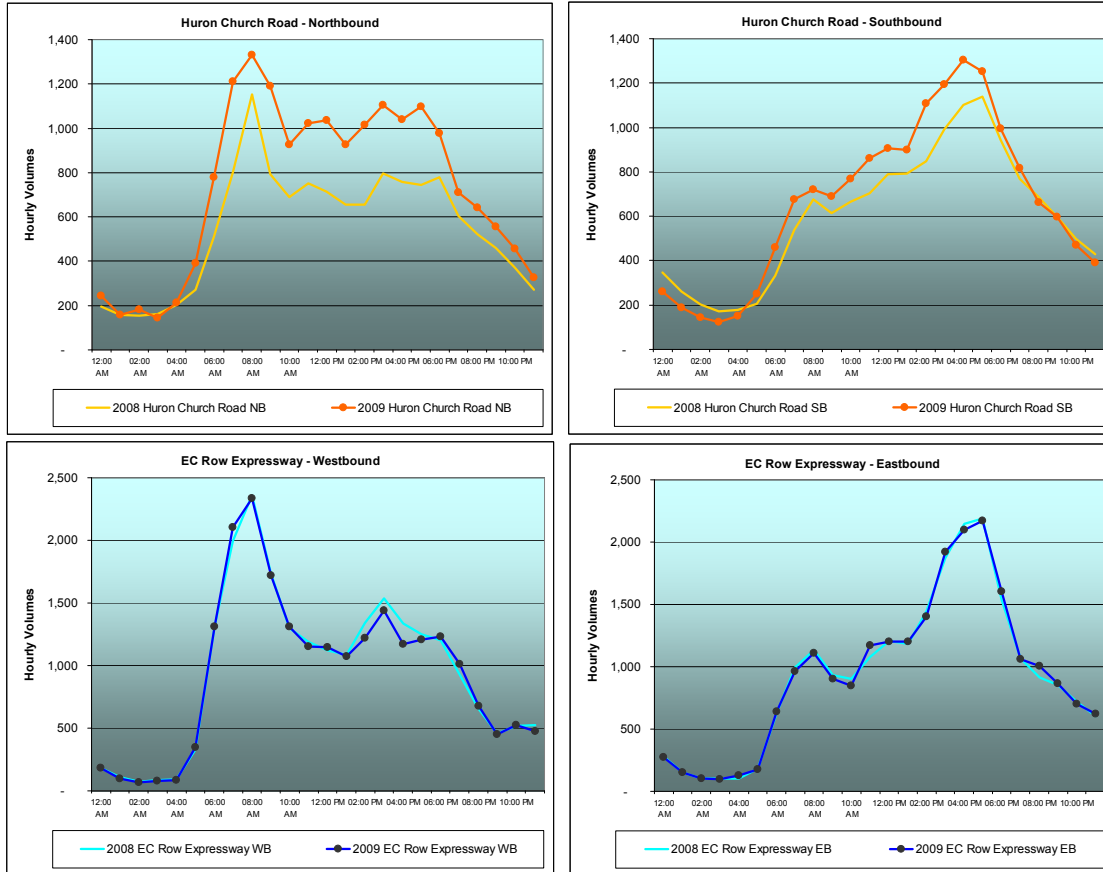

Figure 3-11. Windsor Region Traffic Count Comparison (2008/2009)

Vehicle classification counts were also captured as part of the 2009 data collection to gain a better sense of the overall distribution of trucks at the two locations. **Figure 3-12** illustrates the truck percentages and volumes at the two locations. The truck shares along Huron Church Road were shown to be balanced in both directions and were approximately 25 percent of the total traffic, with an average daily total truck volume of over 8,500 trucks. The E.C. Row Expressway was shown to carry modest truck volumes and showed higher truck volumes in the eastbound direction (over 2,000 daily trucks), compared to the westbound (under 900 daily trucks).

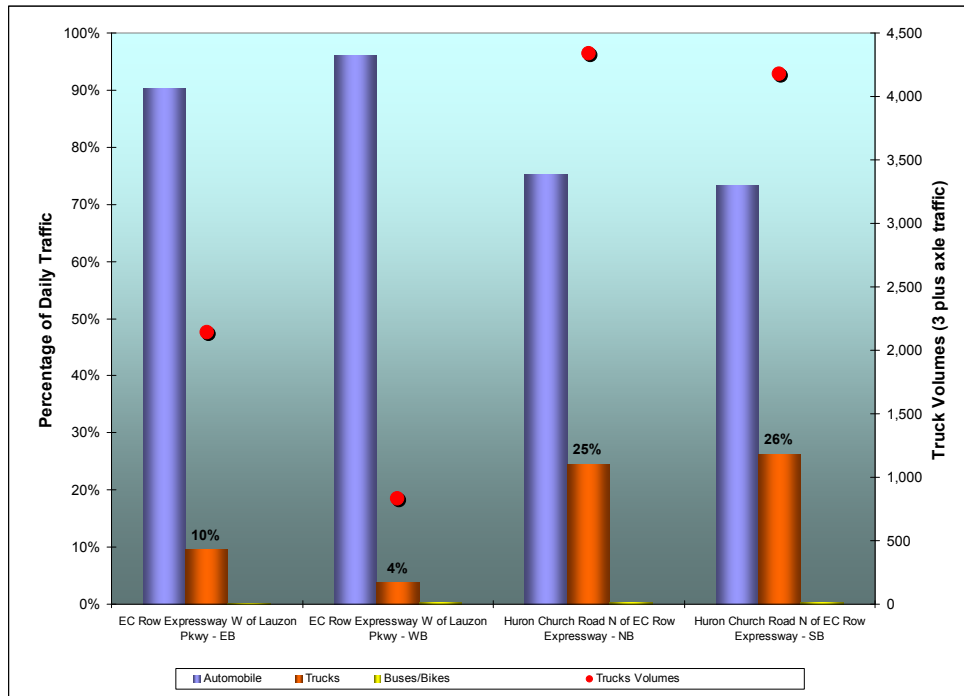

Figure 3-12. Windsor Region Truck Traffic Summary (2009)

BORDER CROSSING COUNT COLLECTION

A detailed understanding of the current traffic profile for the existing international crossings was important to ensure that sufficient information was available to establish a reliable baseline of the international crossing markets, for purposes of calibrating the travel demand models. The 2008 traffic count data collection efforts included seven (7)-day vehicle classification counts for both the U.S. and Canada-bound traffic at the Ambassador Bridge, Detroit-Windsor Tunnel, and Blue Water Bridge. In addition, 12-hour manual vehicle classification counts were conducted at the Ambassador Bridge and Blue Water Bridge.

Ambassador Bridge (2008)

The existing Canada-bound traffic from the Ambassador Bridge has the option to go straight towards Huron Church Road or make a U-turn onto Wyandotte Street. The existing U.S.-bound traffic has three entrances to the bridge that include one directly from Huron Church Road, another via Patricia Road, and the third serving traffic from Wyandotte Street. The 2008 traffic counts originally planned for capture on the Canadian side at Ambassador Bridge were revised and implemented on the U.S. side, following complications related to site limitations and site access approvals from the Ambassador Bridge.

The manual 12-hour counts, on the other hand, were collected successfully on April 16, 2008 at the five entrances/exits to the Ambassador Bridge on the Canadian side. In

addition, automatic seven (7)-day counts at the two entry points into Canada were collected. Review of this data showed that the data quality of the collected counts at the three entrances were flawed due to the high volume of truck traffic that interfered with the count tubes as a result of their queuing characteristics, especially at Patricia Road, where space limitations made it difficult to lay out back-up counter tubes while still remaining outside of the Ambassador Bridge property. A recount effort was undertaken by Midwestern Consulting Inc. based in Michigan, U.S., to capture the seven-day counts on the U.S. side, instead. The Ambassador Bridge, on the U.S. side, has a separate exit for trucks, where trucks are required to turn either eastbound or westbound along Fort Street. Prior to the Gateway construction project, the automobile traffic exiting the Ambassador Bridge could only access I-75 and the local arterial network via local street access. As part of the construction detours, the section of 21st Street that directly connected to the auto toll booth plazas was used to funnel all U.S.-bound traffic from the bridge during the Ambassador Bridge Gateway construction project.

On the U.S. side, the Ambassador Bridge Gateway construction project posed some additional challenges in performing the recount while remaining outside the Ambassador Bridge property. The first round of the recounting along eastbound Fort Street was conducted on May 27, 2008, and vehicle classification counts were successfully obtained for seven (7) days. The westbound tubes at Fort Street and 21st Street were dislodged during the first 48 hours and the tubes that were installed at the driveway to I-75 were removed after one day due to construction activities on the I-75 ramp and closure of the driveway.

The second round of recounting along westbound Fort Street and 21st Street was conducted on June 5, 2008 (21st Street had become the only exit for automobile traffic due to the construction activities). Following several recount efforts, the seven-day counts collected at 21st Street were implemented on June 20, 2008 along 21st Street, immediately after exiting the Ambassador Bridge and further down along Bagley Street, as part of a contingency to ensure that quality data was collected. Bagley Street west of 21st Street was closed for construction at the time of the data collection, thus traffic exiting the bridge could only turn right onto the Bagley Street toward the traffic count location, such that all automobile traffic from the bridge was funneled through this location and would therefore be captured. This last recounting effort was finally successful in capturing a good profile of the automobile traffic entering the U.S. from the Ambassador Bridge. The collected counts covered the weekend and two weekday profiles for use in the 2008 study. The final data collection locations and dates at the Ambassador Bridge are shown in **Table 3-7. Figure 3-13** illustrates the count locations on the U.S. side implemented to capture the U.S.-bound traffic.

Table 3-7 Ambassador Bridge Crossing Counts			
Direction	Location Description	Duration (hours)	Collection Start Date
Automatic Classification Counts			
Entering Canada	Bridge Exit to Huron Church Road (in Canada)	168	04/15/2008
	Bridge Exit to Wyandotte Street (in Canada)	168	04/15/2008
Entering US	Bagley Street West of 21 st Street (in US)	96	06/20/2008
	EB Fort Street East of Bridge Exit (in US)	168	05/27/2008
	WB Fort Street West of Bridge Exit (in US)	168	06/20/2008
Manual Classification Counts			
Bridge Exit to Canada (in Canada)		8am-8pm	04/16/2008
Bridge Entrance to US (in Canada)		8am-8pm	04/16/2008



Figure 3-13. Traffic Count Locations at the US side for the Traffic Entering US through the Ambassador Bridge

Detroit-Windsor Tunnel (2008)

Capture of the access/egress to the Detroit-Windsor Tunnel on the Canadian side was made possible due to the limited access points to the tunnel. Access to the tunnel property was granted such that counts were placed directly within the tunnel on the Canadian side prior to the immigration plazas. Vehicle classification counts were first implemented at Detroit-Windsor Tunnel for seven (7) days on April 15, 2008, however, the data collected was found to be unreliable compared to historical counts and calibration counts

conducted on May 21, 2008. Recounts were then collected on June 5, 2008 for a continuous seven (7) days, as shown in **Table 3-8**.

Table 3-8 Detroit-Windsor Tunnel Crossing Counts		
Location Description	Duration (hours)	Collection Start Date
Automatic Classification Counts		
Bridge Exit to Canada (in Canada)	168	06/05/2008
Bridge Entrance to US (in Canada)	168	06/05/2008

Blue Water Bridge (2008)

Manual vehicle classification counts and automatic classification counts were collected at the Blue Water Bridge at identified locations, as shown in **Figure 3-14**. The 12-hour manual classification counts were conducted on April 17, 2008 on the Canadian side in both directions. The queuing of traffic on the Canadian side along the Highway 402 approach to the bridge required that the automatic counts be conducted on the U.S. side, and were implemented on April 18, 2008. The counts on the U.S. side were conducted at the ramps and freeways connecting to the entrance/exit of the bridge, as illustrated in **Table 3-9** and **Figure 3-14**.

Table 3-9 Blue Water Bridge Crossing Counts			
Direction	Location Description	Duration (hours)	Collection Start Date
Automatic Classification Counts			
Entering Canada	Ramp from I-94 Business route to Bridge (in US)	168	04/18/2008
	Northbound I-94 to Bridge (in US)	168	04/18/2008
Entering US	Ramp from Bridge to northbound I-94 (in US)	168	04/18/2008
	Bridge to southbound I-94 (in US)	168	04/18/2008
Manual Classification Counts			
Bridge Exit to Canada (in Canada 6 am-6 pm)		12	04/17/2008
Bridge Entrance to US (in Canada 6 am-6 pm)		12	04/17/2008



Figure 3-14. Traffic Count Locations at Blue Water Bridge

Border Crossing Counts (2009)

The border crossing traffic counts were again collected as part of the refresh efforts at the same locations identified in the 2008 study. The completion of the Gateway construction project enabled the counts to be performed at the ramps to the I-75 for the U.S.-bound traffic. The counts were performed for a five-day period to capture part of the weekday and weekend in mid-November, 2009. All counts were completed and reviewed for consistency and were deemed of sound quality with the exception of the Detroit-Windsor Tunnel counts and the Canada-bound traffic at the I-94 ramp in Port Huron, which was recounted during the first week of December, 2009. The results from the recount are shown in concert with previously collected data in the subsequent sections. The Detroit-Windsor Tunnel counts were not recounted.

BORDER TRAFFIC COUNT SUMMARY

The collected counts were all summarized and reviewed to ensure that they were of good quality. The counts were evaluated for consistency with the temporal peaking distributions, as well as for consistency across the number of days collected. The traffic distributions were graphed to easily review the differences between the multiple counts, and to check the reasonableness of the traffic profiles, and the peaking and directional characteristics.

The peak traffic distributions were also reviewed to ensure reasonable profiles were obtained within the expected times and in the expected directions. The collected volumes were then compared to the maximum capacity of the facilities based on the number of lanes along which the counts were performed and the roadway type. The counts were also compared to any historical counts within close proximity to the count locations along the numerous roadways to evaluate the traffic trend and to validate the quality of the data collected.

Daily Border Crossing Traffic Counts

The average weekday traffic volumes at the existing crossings within the Detroit/Windsor/Port Huron/Sarnia region that were collected in April/May 2008 are summarized in **Figure 3-15**, while the 2009 counts collected in November are shown in **Figure 3-16**.

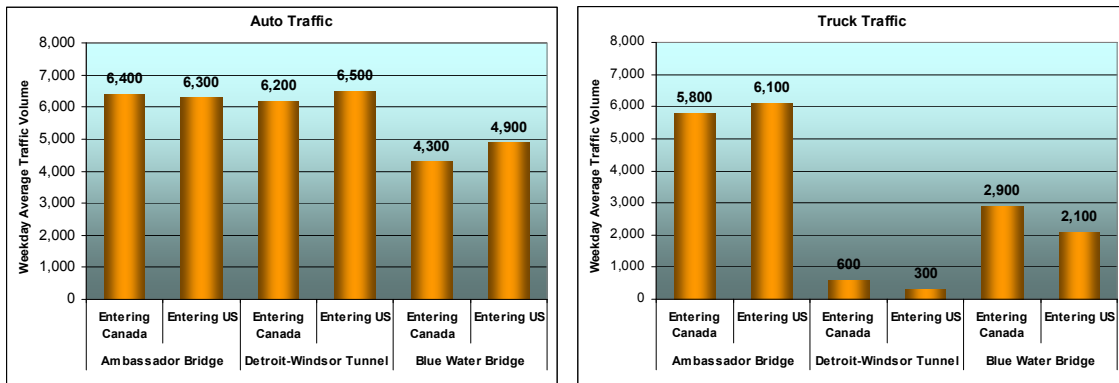
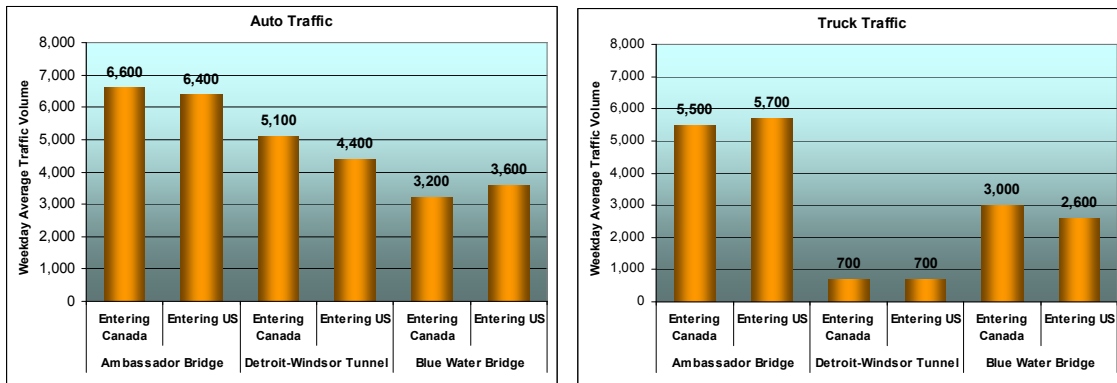

Figure 3-15. Average Weekday Border Crossing Volumes (2008)



Note: the 2009 Detroit-Windsor Tunnel counts were shown to have flawed axle distributions (subject to recount efforts)

Figure 3-16. Average Weekday Border Crossing Volumes (2009)

Further review of the Detroit-Windsor Tunnel counts is ongoing to evaluate the axle classification of the counts. It appears that the recent 2009 U.S.-bound traffic has shown an increase in the truck traffic and decrease in the passenger traffic as compared to the

2008 profile, which showed the U.S.-bound truck traffic was half of the Canada-bound truck traffic with an even directional distribution of the passenger vehicle market. The 2008 auto and truck classification and hourly distributions were used as a reasonable proxy for the distributional characteristics. The Public Border Operators Association (PBOA) data was used to gauge the magnitude of daily traffic at the Detroit-Windsor Tunnel for the 2009 calibration.

Border Crossing Daily Traffic Profiles

The collected traffic counts at the three existing border crossings provided a description of the current temporal distribution of traffic throughout the day during a typical weekday and during the weekend. A comparison to the historical observed distributions collected in 2000, 2004, 2008 and 2009 was undertaken to evaluate the changes that occurred over the last nine years between the automobile and truck traffic and for the different crossing directions.

The Ambassador Bridge crossing profile for the automobile traffic, as shown in **Figure 3-17**, illustrates that the peak traffic occurs in the morning for traffic entering the United States and in the evening for traffic entering Canada. While the overall magnitude of daily volumes has been consistently declining since 2000, the overall peaking distribution of traffic has been shown to remain fairly consistent. The off-peak periods and directions are shown to be capturing much lower overall volumes, which to some extent may be a result of the decline in discretionary traffic compared to the frequent commuter markets.

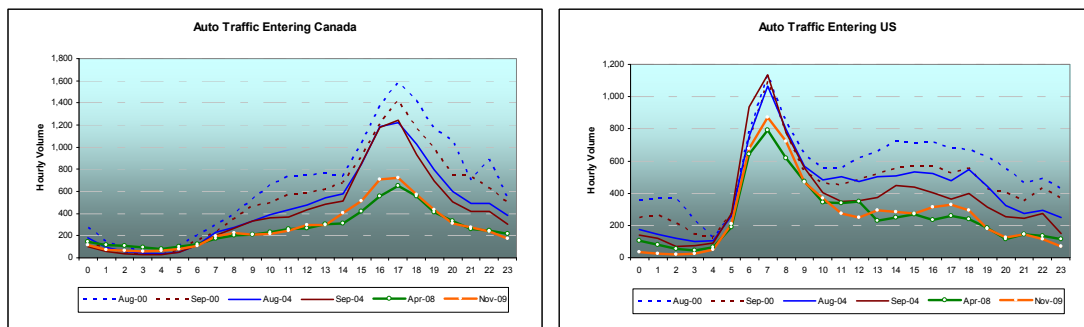

Figure 3-17. Ambassador Bridge Daily Automobile Traffic Distribution

The truck traffic across the Ambassador Bridge has also remained fairly consistent over the last nine years with declines in truck traffic volumes entering Canada, and increases in truck traffic volumes entering the United States since 2000, as shown in **Figure 3-18**. The daily distribution of this traffic typically peaks during the mid-day periods although the more recent trend shows slight peaking characteristics in both the morning and evening peak periods for truck traffic entering the United States.

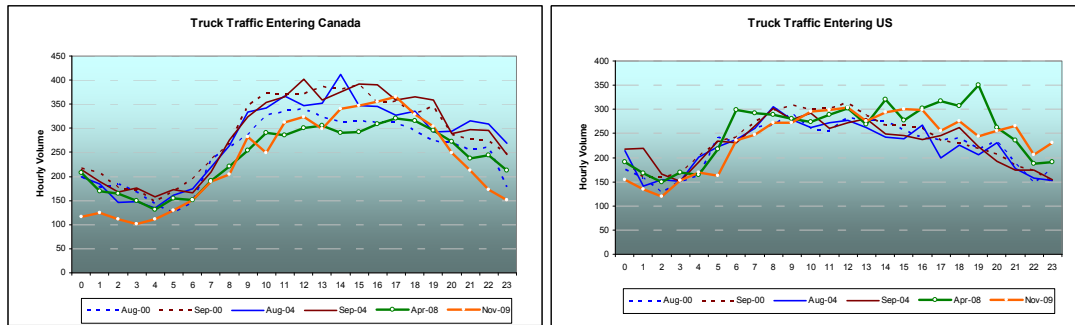
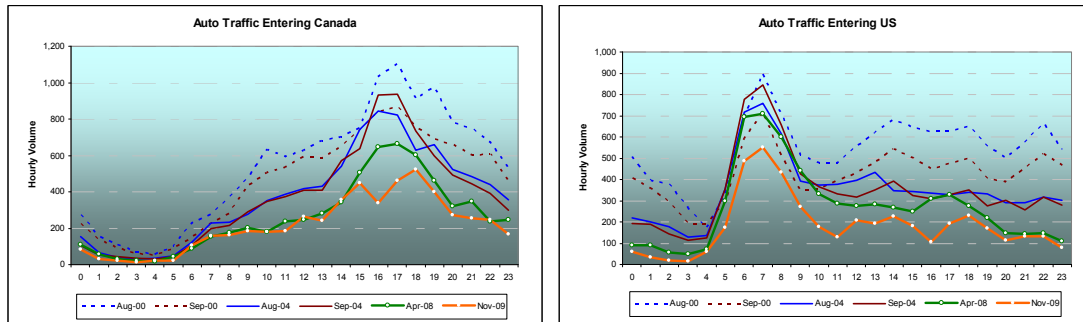

Figure 3-18. Ambassador Bridge Daily Truck Traffic Distribution

The Detroit-Windsor Tunnel crossing profile for the automobile traffic, as shown in **Figure 3-19**, illustrates a similar peaking characteristic to the Ambassador Bridge, with the peak traffic occurring in the morning for traffic entering the United States and in the evening for traffic entering Canada. While the magnitude of automobile volume has been consistently declining since 2000, the overall peaking distribution of traffic has been shown to remain fairly consistent. The off-peak periods and directions are shown to be capturing significantly lower volumes to reflect the likely erosion in discretionary traffic compared to the commuter markets.



Note: U.S.-bound traffic profiles for the Detroit-Windsor Tunnel subject to a recount to account for revised classification shares

Figure 3-19. Detroit-Windsor Tunnel Daily Automobile Traffic Distribution

The magnitude of the peaking traffic entering the United States in the morning has shown less of a decline in traffic compared to the evening peak of traffic entering Canada, where the decline is more prominent. The slower decline in traffic entering the United States in 2008 to some extent is a reflection of the diverted traffic from the bridge as a result of construction activities that impeded accessibility to the bridge. The recent 2009 trends show a more consistent reduction in the overall traffic volumes and peaking characteristics.

The truck traffic across the Detroit-Windsor Tunnel has fluctuated more significantly and this is primarily because of the low volume nature of the truck traffic using the facility. The truck restrictions in place at the tunnel inhibit the truck traffic using this facility and

the market is more volatile in nature, as shown in **Figure 3-20**. An increase in evening peak truck traffic volumes entering Canada in addition to the increase in the overall volume of truck traffic entering the United States was observed with the more recently collected counts compared to the 2000 and 2008 data, although the overall truck volumes are much lower than those captured at the Ambassador Bridge.

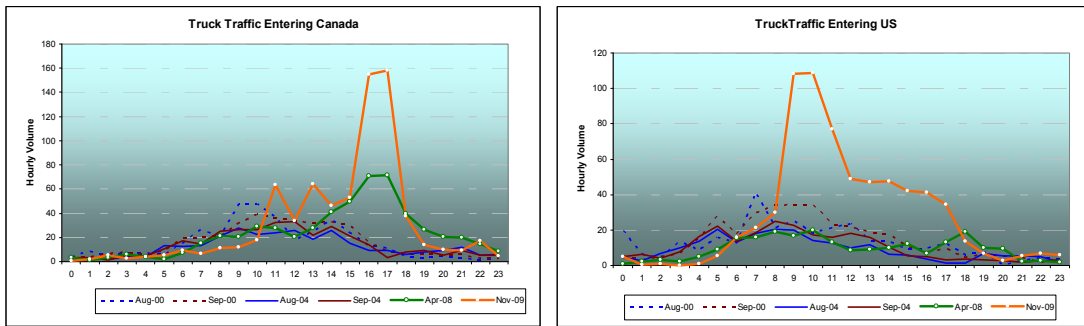

Note: US Bound traffic profiles for the Detroit-Windsor Tunnel subject to change to account for revised classification shares

Figure 3-20. Detroit-Windsor Tunnel Daily Truck Traffic Distribution

An additional visual inspection was performed at the Tunnel to confirm the captured truck trends – the result of which showed much less truck participation than was being captured through the counts, therefore, more confidence was placed in the previous 2008 counts at this location. The daily distribution of this traffic has historically been shown to peak during the late morning and mid-day periods, although the more recent trend shows peaking characteristics in the evening peak periods for both Canada and U.S.-bound truck traffic.

The Blue Water Bridge crossing profile for the automobile traffic, as shown in **Figure 3-21**, illustrates very little peaking traffic during the morning or evening periods occurring. A slight peaking profile in the morning was evident for traffic entering the United States. When compared to the 2000 profile, the typical Blue Water Bridge daily peaking profile remains fairly flat from 9:00 a.m. in the morning until 6:00 p.m. in the evening.

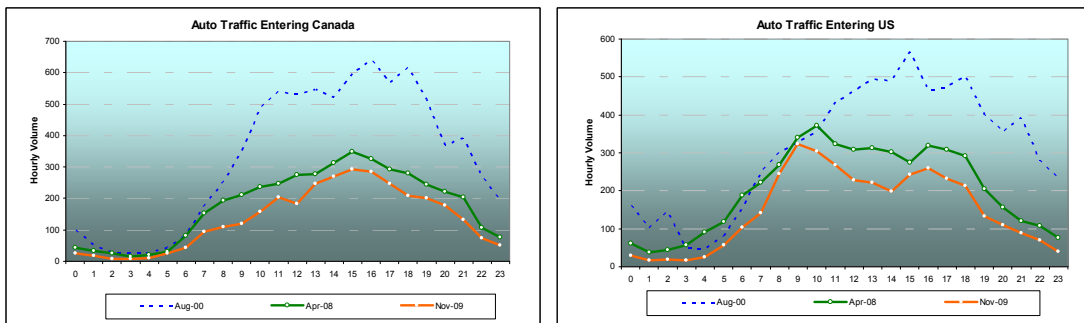

Figure 3-21. Blue Water Bridge Daily Automobile Traffic Distribution

The hourly distributional profile has not changed dramatically since 2000; however, a significant drop in overall traffic volumes is evident with the loss occurring in both the Canada and the U.S.-bound traffic for both 2008 and 2009.

The truck traffic across the Blue Water Bridge has remained fairly consistent since 2000, with a flat distribution over the course of the day, as shown in **Figure 3-22**. An increase in truck traffic volumes entering Canada was shown in 2008 and appears to be continuing in 2009. The drop in traffic entering the United States in 2008 has since rebounded back to the typical hourly profile for this crossing and is similar to the distribution in the 2000 levels.

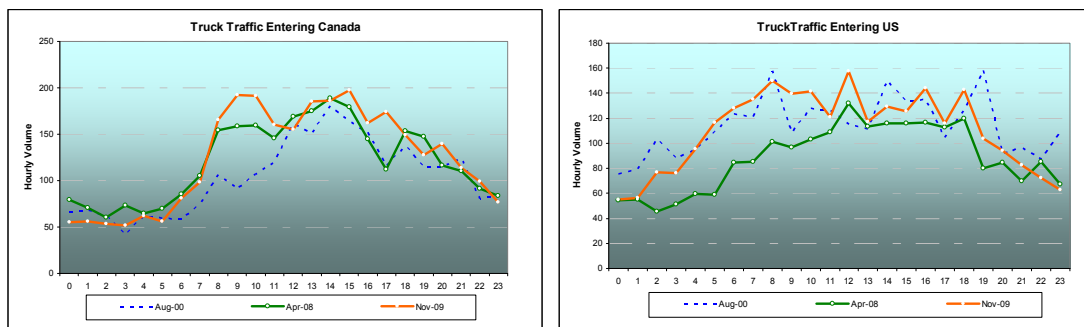

Figure 3-22. Blue Water Bridge Daily Truck Traffic Distribution

Vehicle Classification Counts

The vehicle classification counts conducted at the three existing crossings included both Canada and U.S.-bound traffic to gauge the axle distribution of the existing border crossing traffic demand. The vehicle classification counts were also complemented with manual classification counts conducted in 2008 at the Ambassador Bridge and Detroit-Windsor Tunnel. **Table 3-10** provides a summary of the total directional vehicle classification counts captured at the three existing crossings in 2009.

The over five-axle vehicles at the Ambassador Bridge accounts for over 30 percent of the daily weekday traffic, with the peak shares reaching over 38 to 42 percent for the U.S. and Canada-bound traffic, respectively, in 2009. This share is greatly reduced during the weekends, when the five-axle vehicles only accounted for 13 to 14 percent of the overall daily weekend traffic in 2009. The night-time share for the over five-axle traffic at the Ambassador Bridge was shown to yield the highest shares in both directions of traffic compared to all other time periods, and showed that there are a significant number of trucks using the facility during this period. This trend was shown to be increasing in 2009, most likely as a result of the overall decline in the passenger market daily traffic. The Detroit-Windsor Tunnel is shown to capture a large share of the two-axle (automobile) traffic during all the time periods and directions with the over five-axle vehicles only accounting for 1.0 to 5.0 percent of the overall daily weekday traffic

volumes. The two-axle (automobile) traffic shares are shown to increase even more during the off-peak and weekends.

**Table 3-10
Border Crossing Vehicle Axle Distribution**

Border Crossing		Time Period	2009			
			Buses Bikes	2 Axle Vehicles	3 or 4 Axle Vehicles	5 or More Axle Vehicles
Canada-Bound	Ambassador Bridge	DY-WD	2.5%	55.2%	2.3%	33.1%
		AM	2.9%	44.6%	2.5%	42.9%
		PM	2.3%	62.8%	2.6%	25.5%
		NT	2.8%	49.1%	2.0%	39.6%
		DY-WE	1.4%	82.1%	1.3%	13.4%
	Detroit-Windsor Tunnel*	DY-WD	1.1%	92.1%	3.7%	3.1%
		AM	1.2%	90.0%	3.8%	5.0%
		PM	0.6%	92.2%	3.8%	3.4%
		NT	1.2%	93.4%	3.3%	2.1%
		DY-WE	1.0%	95.1%	2.7%	1.3%
	Blue Water Bridge	DY-WD	0.7%	56.6%	4.7%	38.0%
		AM	1.2%	49.4%	4.8%	44.7%
		PM	0.5%	64.5%	5.7%	29.3%
		NT	0.7%	54.0%	4.1%	41.2%
		DY-WE	0.4%	74.5%	1.5%	23.5%
Canada-Bound	Ambassador Bridge	DY-WD	4.5%	59.7%	1.7%	31.5%
		AM	3.7%	54.7%	1.6%	37.6%
		PM	4.2%	67.8%	1.5%	24.5%
		NT	6.3%	42.1%	2.3%	46.0%
		DY-WE	3.0%	79.8%	1.2%	14.4%
	Detroit-Windsor Tunnel*	DY-WD	0.4%	96.3%	1.6%	1.6%
		AM	0.2%	95.8%	2.1%	1.9%
		PM	0.8%	96.6%	1.7%	1.0%
		NT	0.5%	97.2%	0.8%	1.5%
		DY-WE	0.3%	97.4%	1.4%	0.9%
	Blue Water Bridge	DY-WD	3.3%	58.1%	2.5%	36.1%
		AM	1.4%	79.5%	1.2%	17.9%
		PM	3.8%	55.1%	2.6%	38.4%
		NT	5.2%	38.3%	4.0%	52.5%
		DY-WE	2.5%	75.6%	2.5%	19.5%

Note: DY-WD: daily weekday; AM: 6:00 am - 9:00 am; PM: 3:00 pm - 7:00 pm; NT: 7:00 pm - 6:00 am; DY-WE: daily weekend

*Reflects 2008 Traffic Count Data

The over five-axle vehicles at the Blue Water Bridge account for approximately 36 to 38 percent of the daily weekday traffic, with the peak shares reaching over 38 to 45 percent

for the U.S. and Canada-bound traffic, respectively. This share is also greatly reduced during the weekends, with the five-axle vehicles only accounting for approximately half of the weekday shares at 20 to 24 percent of the overall daily weekend traffic. The relatively low automobile utilization at the Blue Water Bridge shows that the truck traffic is a significant market at this border crossing.

A more detailed review of the directional and weekday versus weekend axle-distribution (under the 13 vehicle classifications) at the Ambassador Bridge, as illustrated in **Figure 3-23**, shows that the bridge captures a high percentage of five-axle vehicles with the weekend U.S.-bound traffic yielding the highest overall shares. The remaining classifications have very low shares compared to the car and trailer, and five-axle double vehicles classifications. The 2009 counts indicated that very little change had occurred in the overall vehicle classification shares for the traffic at the Ambassador Bridge compared to the 2008 counts.

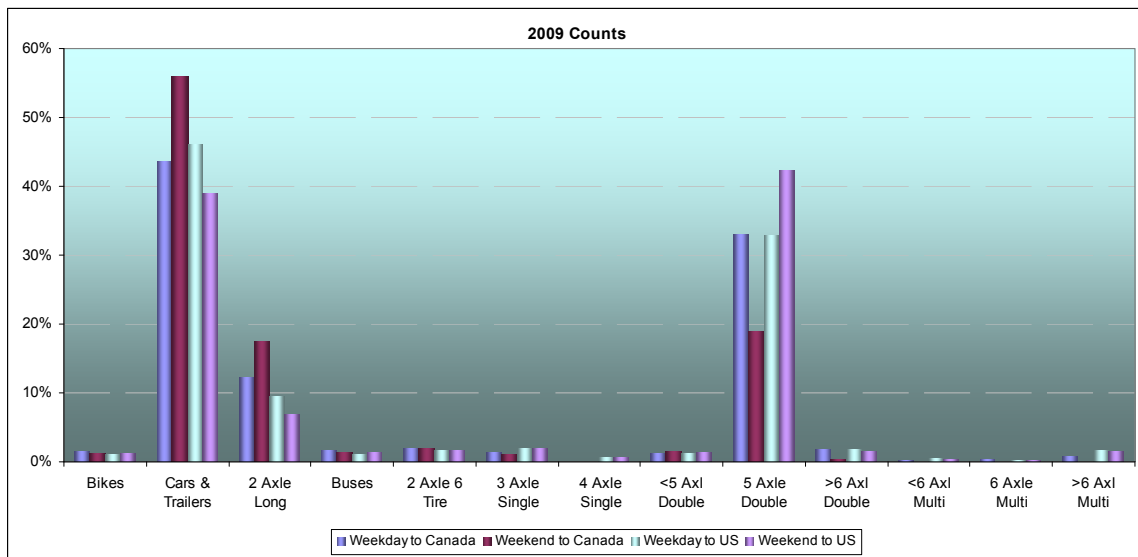
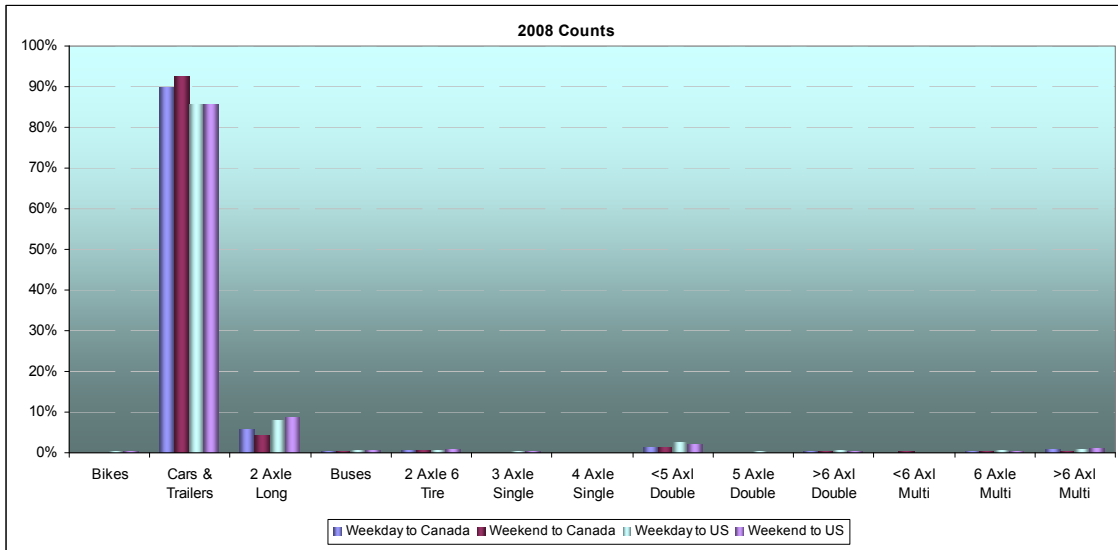

Figure 3-23. Ambassador Bridge Vehicle Classification Summary (2009)

The detailed review of the directional and weekday versus weekend axle-distribution at the Detroit-Windsor Tunnel, as illustrated in **Figure 3-24**, shows that the tunnel captures a high percentage of cars and trailers with the Canada-bound weekend traffic yielding the highest overall shares. The remaining classifications have very low shares with a slightly higher share for the two-axle long vehicle classification.



Note: 2009 Detroit-Windsor Tunnel counts are not summarized pending further review and recount

Figure 3-24. Detroit-Windsor Tunnel Vehicle Classification Summary (2008)

The detailed review of the directional and weekday versus weekend axle-distribution at the Blue Water Bridge, as illustrated in **Figure 3-25**, shows that the bridge captures a high percentage of five-axle vehicles with the U.S.-bound weekend traffic yielding the highest overall shares similar to the Ambassador Bridge distribution. The remaining classifications have very low shares compared to the car and trailer and five-axle double vehicles classifications. The Canada-bound car and trailer traffic during the weekend have significantly lower shares of 5-axle double vehicles, compared to the U.S.-bound traffic.

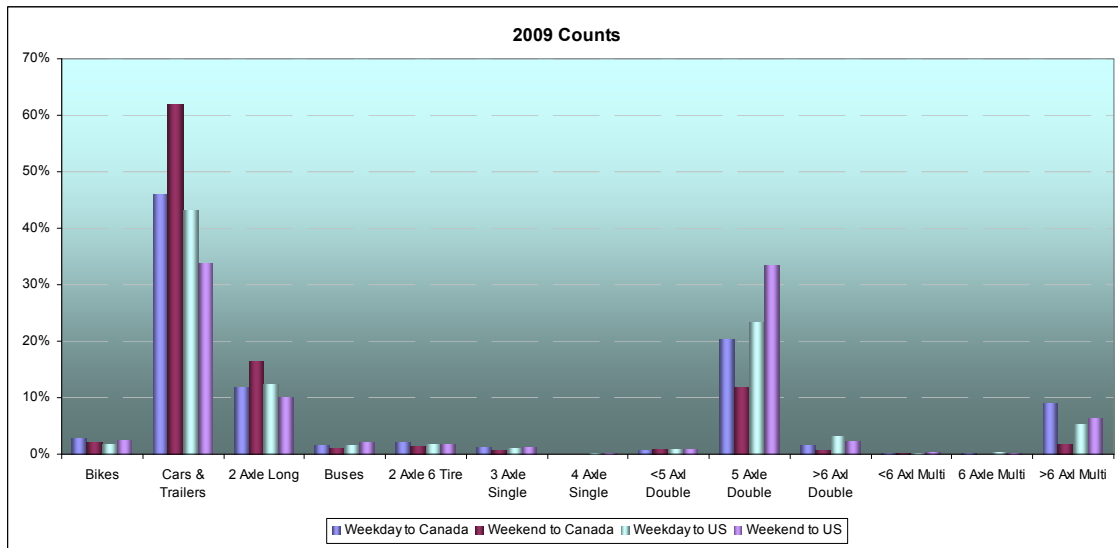

Figure 3-25. Blue Water Bridge Vehicle Classification Summary (2009)

Weekday versus Weekend Profiles

An analysis of the weekly distribution of the traffic counts and the seven-day count obtained at the three crossings outlined the differences between the typical weekday and weekend traffic volume demand. The automobile traffic during the weekend at all three crossings was shown to range between 70 percent and 139 percent, as shown in **Table 3-11**. The traffic at the Blue Water Bridge, in particular, was shown to be higher during the weekend than the weekday particularly for the Canada-bound traffic.

Table 3-11 Weekend Traffic as a Percentage of Weekday Traffic (2009)				
Facility	Automobile		Trucks	
	Canada-bound	U.S.-bound	Canada-bound	U.S.-bound
2009				
Ambassador Bridge	71%	93%	37%	42%
Detroit-Windsor Tunnel*	86%	84%	45%	78%
Blue Water Bridge	139%	129%	33%	41%

*Based on 2008 traffic count data profiles

The weekend truck traffic at the Ambassador Bridge was shown to be range within 37 to 42 percent of the weekday traffic in 2009, and the Blue Water Bridge exhibited a similar weekend traffic capture that ranged between 33 and 41 percent. The Detroit-Windsor Tunnel truck traffic fluctuated more significantly between 45 and 78 percent, and is more reflective of the low-volume specialized truck market using this crossing.

A more detailed analysis of the peaking and temporal distribution of traffic between the weekday and weekend for the Ambassador Bridge is shown in **Figure 3-26**. The distribution of automobile and truck traffic during the weekend remains fairly flat over most of the day and is uniformly distributed between the morning and evening periods. The overall volumes, as summarized in **Table 3-11**, show that the automobile weekend traffic is over 70 percent of the weekday traffic while the truck traffic accounts for a much lower overall percentage of the weekday traffic.

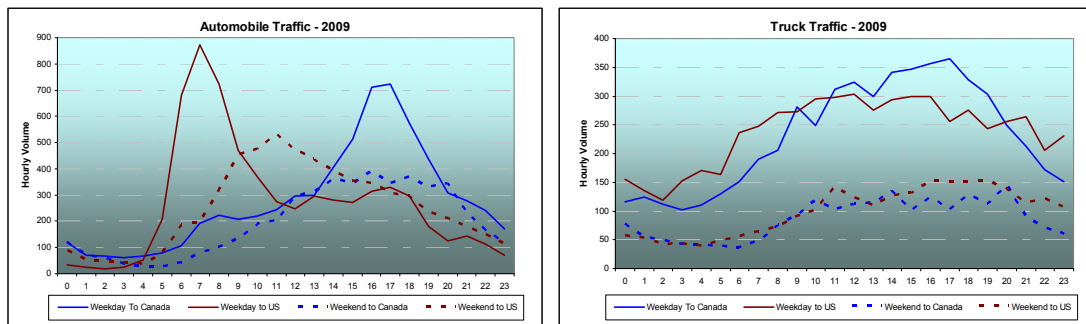

Figure 3-26. Ambassador Bridge Weekday/Weekend Traffic Distribution (2009)

A more detailed analysis of the peaking and temporal distribution of traffic between the weekday and weekend for the Detroit-Windsor Tunnel is shown in **Figure 3-27**.

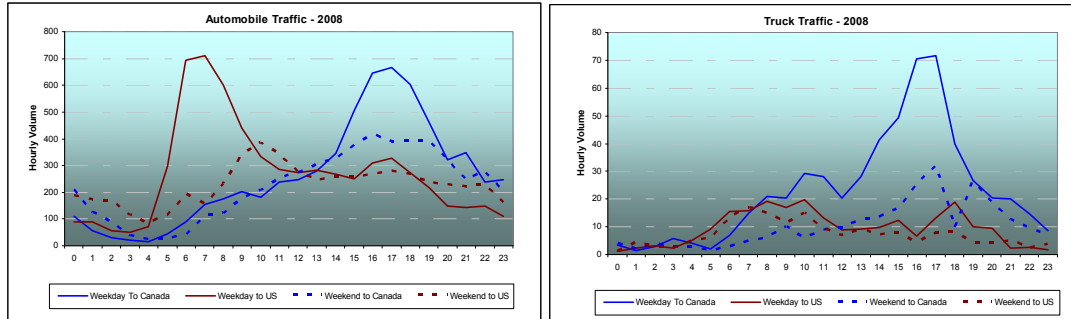

Figure 3-27. Detroit-Windsor Tunnel Weekday/Weekend Traffic Distribution (2008)

The distribution of automobile and truck weekend traffic appears to mimic the weekday traffic profiles with some slight peaking characteristics for the respective crossing directions. The overall volumes, as summarized in **Table 3-11**, show that the automobile weekend traffic is close to 80 percent of the weekday traffic while the truck traffic is much lower in magnitude, especially for the Canada-bound traffic.

A more detailed analysis of the peaking and temporal distribution of traffic between the weekday and weekend for the Blue Water Bridge is shown in **Figure 3-28**. The distribution of automobiles during the weekday is lower than the weekend traffic at this crossing and exhibited a somewhat flat profile for most of the day with very similar overall peaking distributions in both directions. The overall volumes, as summarized in **Table 3-11**, show that the truck traffic was approximately 33 to 41 percent of the weekday traffic and the distribution between the weekday and weekend were very similar and uniformly distributed throughout the day.

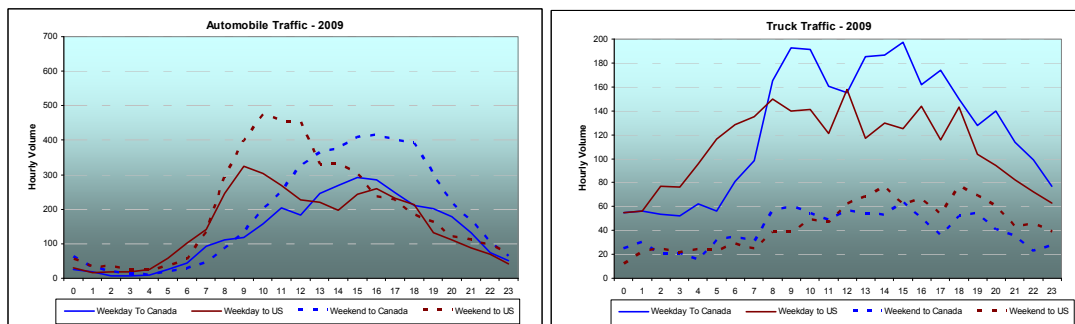
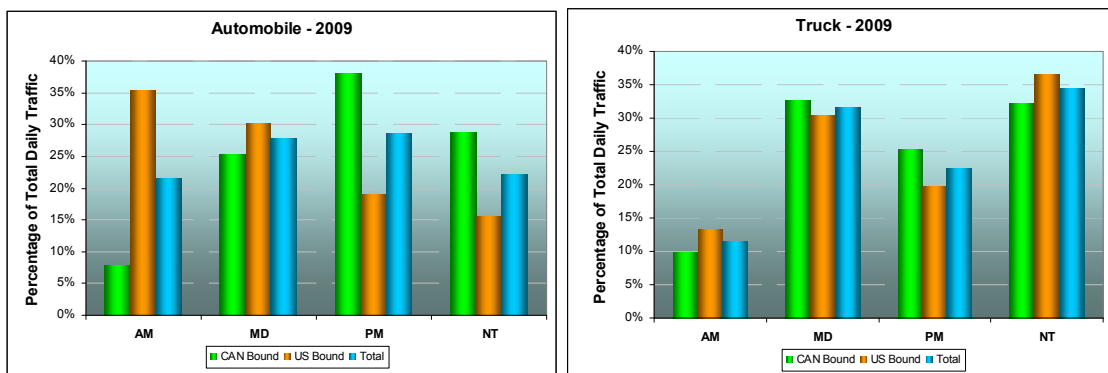

Figure 3-28. Blue Water Bridge Weekday/Weekend Traffic Distribution (2009)

Traffic Demand Period Segmentation

The following outlines the period distributions that were used to segment the international crossing trip tables as part of the model enhancement and updating efforts described later in Chapter 5. The Ambassador Bridge, as shown in **Figure 3-29**, illustrates that the automobile traffic in the morning and evening peak periods captures approximately 21 and 29 percent, respectively, while the truck traffic captures just over 12 and 22 percent during the same peak periods. The night-time share of truck traffic at the Ambassador Bridge accounts for close to 35 percent of the overall daily traffic at this crossing. This demonstrates that a significant amount of the truck traffic is crossing the current bridge during the mid-day and night time periods.



AM (6:00 am - 9:00 am), MD (9:00 am - 3:00 pm), PM (3:00 pm - 7:00 pm), NT (7:00 pm - 6:00 am)
Figure 3-29. Ambassador Bridge Weekday Period Distribution (2009)

The Detroit-Windsor Tunnel, as shown in **Figure 3-30**, illustrates that the automobile traffic in the morning and evening peak periods captures approximately 19 and 28 percent, respectively, while the truck traffic captures just over 12 and over 36 percent during the same peak periods.

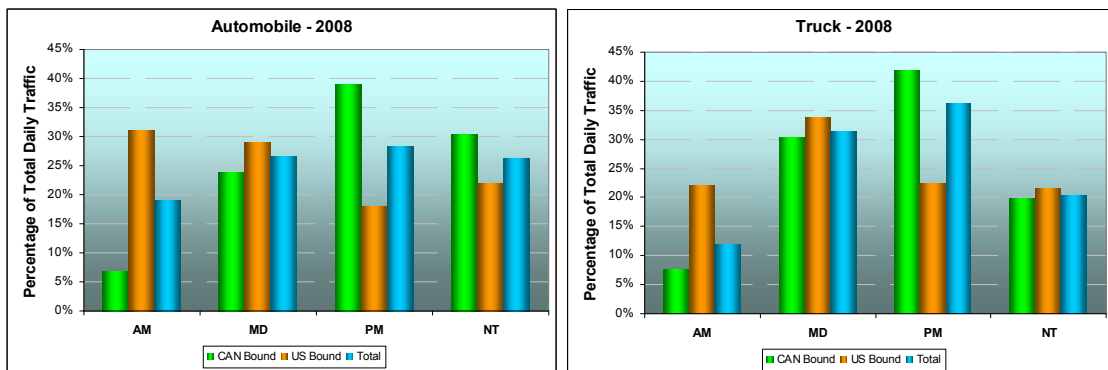

AM (6:00 am - 9:00 am), MD (9:00 am - 3:00 pm), PM (3:00 pm - 7:00 pm), NT (7:00 pm - 6:00 am)
Figure 3-30. Detroit-Windsor Tunnel Weekday Period Distribution (2008)

The Blue Water Bridge, as shown in **Figure 3-31**, illustrates that the automobile traffic in the morning and evening peak periods captures approximately 11 and 29 percent, respectively, while the truck traffic captures approximately 13 and 22 percent during the same peak periods. The mid-day and night-time share of truck traffic at the Blue Water Bridge each accounts for close to 65 percent of the overall daily traffic, and reflects a very similar distribution to the Ambassador Bridge truck traffic period segmentation which shows that over 65 percent of the overall border crossing traffic is travelling during the mid-day and night-time periods.

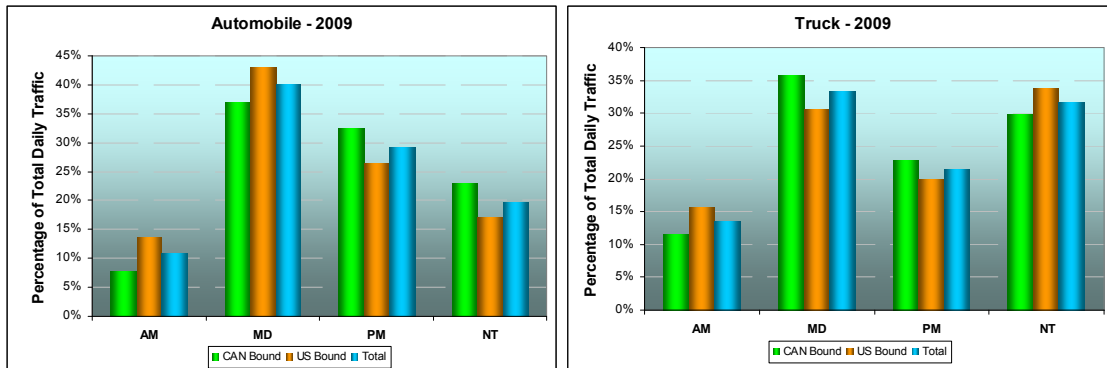

AM (6:00 am - 9:00 am), MD (9:00 pm - 3:00 pm), PM (3:00 pm - 7:00 pm), NT (7:00 pm - 6:00 am)
Figure 3-31. Blue Water Bridge Weekday Period Distribution (2009)

ORIGIN DESTINATION SURVEY

An Origin-Destination (OD) survey was conducted as part of this study to identify the major travel patterns across the three existing crossings and to update the travel demand models accordingly with any observed changes. The survey was only performed for the passenger vehicle market since the commercial vehicle OD survey data from the 2006 National Roadside Survey (NRS) of commercial vehicles conducted by Transport Canada was available for use as part of the study. This section provides a summary of the passenger vehicle OD survey implementation. The results are summarized for trip distributions and trip characteristics for the passenger and commercial vehicle markets. A more detailed description of the OD survey implementation and results can be found in Appendix A.

PASSENGER VEHICLE SUMMARY

Survey Implementation

The OD survey was conducted at the three existing crossings along the Ambassador Bridge, the Detroit-Windsor Tunnel, and the Blue Water Bridge in the Detroit-Windsor and Port Huron-Sarnia region. Roadside surveys were originally planned to be undertaken at all the three crossings for both directions, however, complications in

obtaining final approvals to implement roadside surveys at several locations required that a mail-back survey approach be adopted instead. **Table 3-12** shows the survey dates and methods implemented at each crossing during the mid-weekdays for a 24-hour period over the week of April 14, 2008.

Passenger Car OD Survey Implementation				
Crossing	Method	Direction	Dates	Hours
Ambassador Bridge	Mail-back	Canada-bound	Tuesday, April 15, 2008	0:00 a.m. – 11:59 p.m.
			Wednesday, April 16, 2008	
Detroit-Windsor Tunnel	Mail-back	Canada-bound	Tuesday, April 15, 2008	0:00 a.m. – 11:59 p.m.
			Wednesday, April 16, 2008	
	Roadside	Canada-bound	Tuesday, April 15, 2008	0:00 a.m. – 11:59 p.m.
Blue Water Bridge	Roadside	Canada-bound / US-bound	Thursday, April 17, 2008	0:00 a.m. – 11:59 p.m.

The OD survey design used in the study was similar to the previous Ontario-Michigan Border Crossings Study performed in 2000, with some minor changes made to the design to facilitate the revised implementation of the survey. The OD survey was performed in both directions at the Blue Water Bridge, while only the Canada-bound direction was surveyed at the two existing Detroit-Windsor crossings. The questions regarding the U.S.-bound trips were designed to evaluate the reverse direction tendencies at these two crossings.

Survey Collection Results

Table 3-13 summarizes the number of roadside surveys that were collected at each site including the average weekday (Tuesday to Thursday) traffic counts that were also simultaneously collected. The number of surveys collected surpassed the initial roadside field quotas that were established by the study team. A total of 1,083 surveys were collected for the Canada-bound direction at the Detroit-Windsor Tunnel, which represented an intercept rate of 17 percent. The Blue Water Bridge captured 1,612 surveys in both directions of travel, which represented an intercept rate of 18 percent. The mail-back survey collection results are shown in **Table 3-14**. Approximately 15,400 surveys were handed out during the two-day survey time period at the two crossings. A total of 2,384 mail-back surveys were returned, representing an average response rate of 15 percent at both crossings. Individual response rates were 17 percent for the Ambassador Bridge and 15 percent for the Detroit-Windsor Tunnel. The returned mail-back surveys accounted for approximately 9 percent of the total traffic volumes observed at Ambassador Bridge for the Canada-bound traffic and 10 percent at Detroit-Windsor Tunnel for the Canada-bound traffic.

Facility	Direction	Number of Surveys	Observed Traffic Volume	Intercept Rate
Detroit–Windsor Tunnel	Canada-bound	1,083	6,221	17%
Blue Water Bridge	Canada-bound & U.S.-bound	1,612	9,157	18%
Total		2,695	15,378	18%

Facility	Direction	Approx. Packages Distributed	Responses Received	Response Rate ¹	Observed Two-day Canada-bound Volume	Proportion of Traffic Volume
Ambassador Bridge	Canada-bound	6,900	1,150	17%	12,700	9%
Detroit–Windsor Tunnel	Canada-bound	8,500	1,234	15%	12,400	10%
Total		15,400	2,384	15%	25,100	9.5%

¹ proportion of package distributed

The OD survey responses collected from the field were entered into the database and reviewed based on several criteria that included valid trip time, valid trip origin and destination, trip purpose, and valid information for geo-coding. The origin and destination were then geo-coded into a geographic information system (GIS) software format for further analysis. Some additional origin and destination information was obtained from the stated-preference survey performed as part of this study. The U.S.-bound traffic profiles and trip records were obtained by transposing the information provided by the survey respondents (only those U.S.-bound trips that indicated that they intended to use one of the study crossings for the return trip were used).

Trip Distributions

The spatial distribution of the passenger car trip origins and destinations are presented in **Figure 3-32** for the three study crossings and by direction. **Tables 3-15** through **3-17** show the proportion of trips using the travel origin-destination super zones, as outlined in **Figure 3-33**.

DRAFT

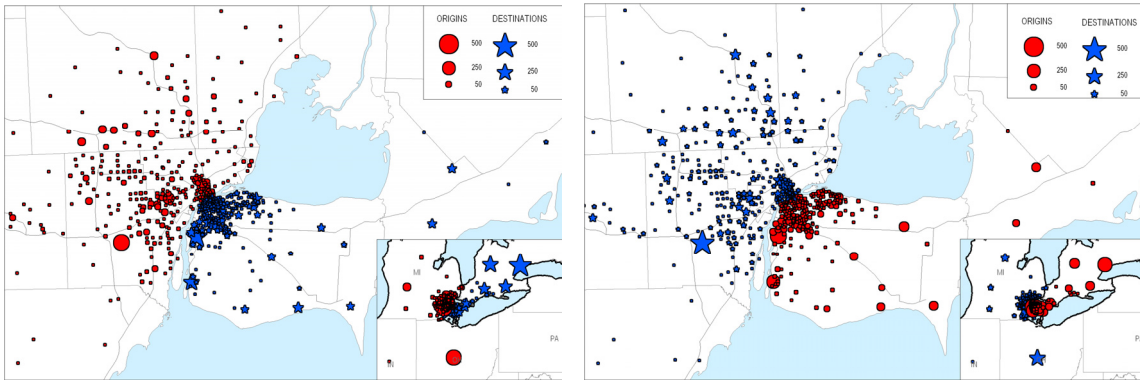

Ambassador Bridge – to Canada

Ambassador Bridge – to US

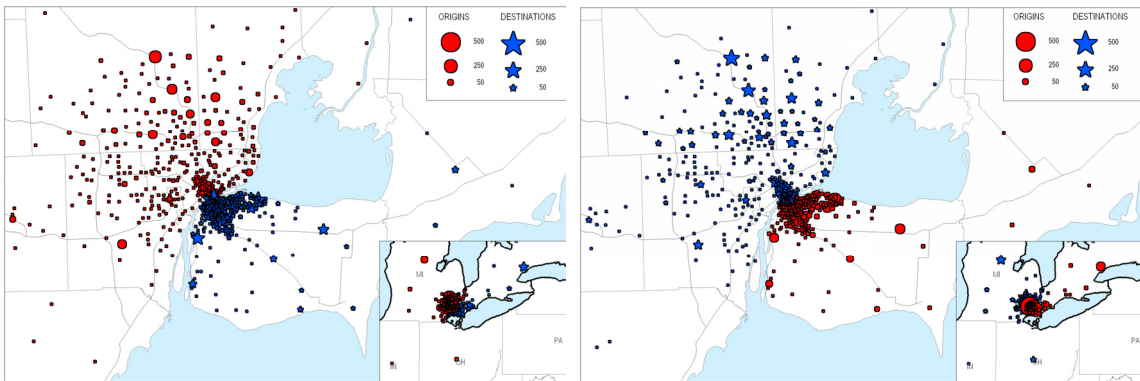

Detroit-Windsor Tunnel – to Canada

Detroit-Windsor Tunnel – to US

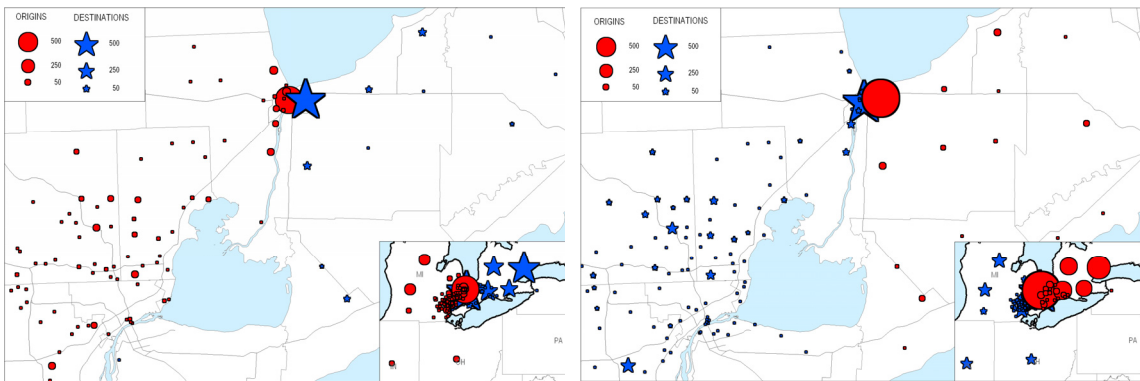

Blue Water Bridge – to Canada

Blue Water Bridge – to US

Figure 3-32. Weekday Passenger Car Trip Origins & Destinations

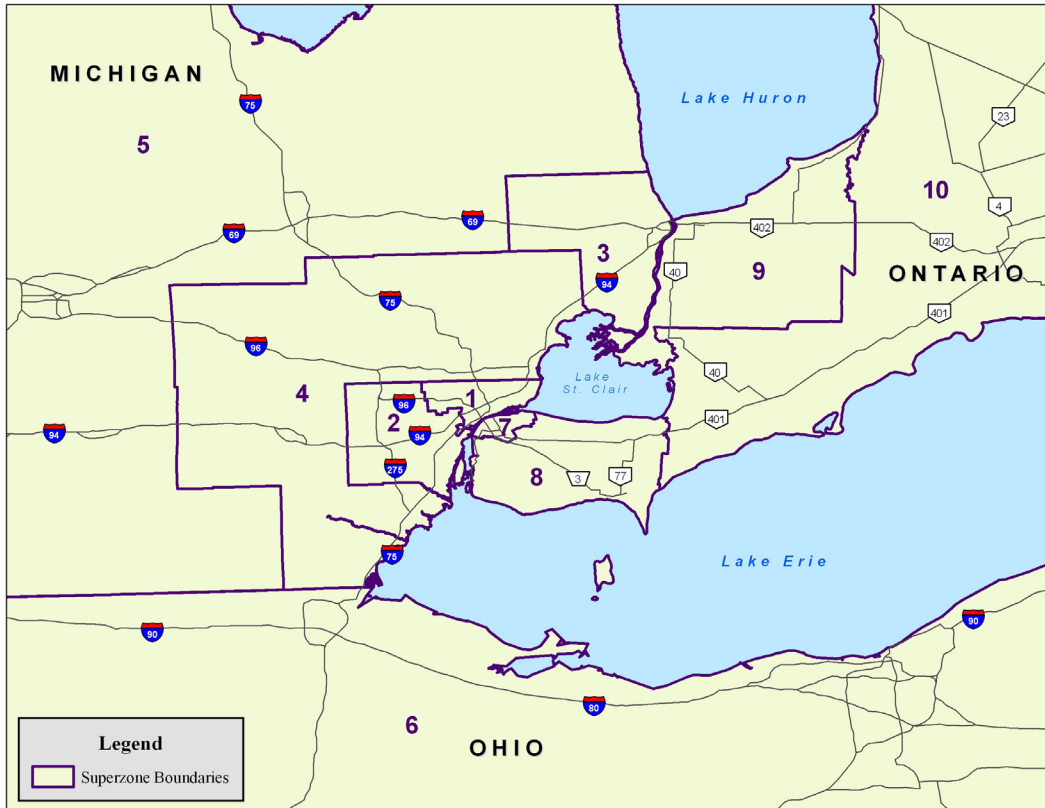

Figure 3-33. Location of Super Zones

Origin	Destination										Total
	1	2	3	4	5	6	7	8	9	10	
1 Detroit + NE Wayne							6%	5%		1%	12%
2 Rest of Wayne Co.						0%	10%	6%		2%	18%
3 Port Huron/St. Clair Co.							0%	0%	0%	0%	0%
4 Rest of SEMCOG							5%	4%		1%	10%
5 Rest of Michigan							1%	0%		0%	1%
6 Other USA/Mexico				0%			2%	1%		6%	9%
7 Windsor	6%	9%	0%	8%	1%	1%				0%	25%
8 Rest of Essex Co.	6%	6%	0%	5%	0%	1%				0%	18%
9 Sarnia/Lambton Co.	0%										0%
10 Other Ontario/Canada	1%	1%		1%	0%	4%	0%			0%	7%
Total	13%	16%	0%	14%	1%	6%	23%	16%	0%	11%	100%

Origin	Destination										
	1	2	3	4	5	6	7	8	9	10	Total
1 Detroit + NE Wayne						0%	15%	5%	0%	1%	21%
2 Rest of Wayne Co.							4%	1%		0%	6%
3 Port Huron/St. Clair Co.							0%			0%	0%
4 Rest of SEMCOG							15%	4%		1%	20%
5 Rest of Michigan							1%	0%		0%	1%
6 Other USA/Mexico							0%	0%		0%	1%
7 Windsor	14%	5%	0%	18%	1%	1%			0%	0%	38%
8 Rest of Essex Co.	5%	1%		4%	0%	0%				0%	11%
9 Sarnia/Lambton Co.				0%			0%	0%			0%
10 Other Ontario/Canada	1%	0%	0%	1%	0%	0%					2%
Total	20%	6%	0%	23%	1%	1%	36%	10%	0%	2%	100%

Origin	Destination										
	1	2	3	4	5	6	7	8	9	10	Total
1 Detroit + NE Wayne						0%			0%	1%	1%
2 Rest of Wayne Co.									0%	2%	3%
3 Port Huron/St. Clair Co.						0%			12%	4%	16%
4 Rest of SEMCOG						1%			2%	7%	10%
5 Rest of Michigan						2%		0%	1%	3%	6%
6 Other USA/Mexico	0%	0%	0%	1%	1%	0%			1%	9%	13%
7 Windsor			0%	0%					0%		0%
8 Rest of Essex Co.											0%
9 Sarnia/Lambton Co.	0%	1%	16%	2%	1%	1%	0%	0%		0%	23%
10 Other Ontario/Canada	1%	3%	4%	8%	4%	8%		0%	0%	1%	28%
Total	1%	4%	20%	11%	6%	13%	0%	0%	16%	27%	100%

The Ambassador Bridge, with an average weekday volume of approximately 14,300 cars, serves both local and long-distance traffic. Almost three-quarters of the captured travel were between the Southeast Michigan Council of Governments (SEMCOG) area and Windsor-Essex, with only approximately 12 percent shown to be occurring directly between the cities of Windsor and Detroit. The remaining quarter had origins/destinations that were much farther away. On the U.S. side, only approximately 1 percent of travel was origin/destined to the rest of Michigan, with the majority of travel indicating origins/destinations in Ohio and the southern states along the coast, such as Florida. On the Canadian side, a large share of the long-distance travel was shown to have origins/destinations to the Greater Toronto Area and other areas in Ontario. A very small proportion of the captured traffic indicated origins/destinations to the rest of the country.

The Detroit-Windsor Tunnel during the survey was shown to carry an average daily weekday volume of approximately 11,800 cars. Compared to the Ambassador Bridge, it is far more oriented to Windsor-Essex/SEMCOG regional traffic, which accounted for over 90 percent of the overall captured volumes, with almost 30 percent showing origins/destinations between the cities of Windsor and Detroit. The location of the tunnel directly within the two cities Central Business Districts (CBDs) makes it an ideal candidate for this market segment. Virtually no long-distance to long-distance traffic was captured at this location, primarily because of the lack of direct connections to the freeway systems on each side of the border, and the difficulty in finding and accessing the facility.

The average daily weekday car volumes along the Blue Water Bridge during the survey implementation were approximately 8,400 vehicles. Roughly 28 percent of traffic at this bridge was shown to be local-to-local, defined as Lambton County on the Canadian side and St. Clair County on the U.S. side. The relatively smaller sizes of the cities of Sarnia and Port Huron compared to the Windsor/ Detroit cities demonstrated a smaller cross-border commuting pattern and thus showed that a more substantial proportion of travel along this bridge was long-distance in nature. On the Canadian side, over one-quarter of traffic was shown to be going to or from other parts of Ontario, while approximately 13 percent of travel had origins/destinations that were to other states other than Michigan.

Trip Characteristics

A review of the trip purposes at the three crossings was undertaken to correlate the traffic patterns to the various markets that each respective crossing was capturing. **Figure 3-34** describes the purpose breakdowns across an entire weekday along the three crossings, as well as the total frontier, and summarizes some key variables captured during the OD survey.

Much of the captured traffic at the Detroit-Windsor crossings was attributable to work/business travel and accounted for up to 60 percent of the captured travel. The Tunnel was shown to have a very high proportion of local-to-local travel given the direct downtown-to-downtown connection that it provides. A significant number of Windsor residents commute to Detroit each day, given the draw of the city as a major employment center. The 2006 Canadian Census showed that almost 5 percent of employed workers in Windsor worked outside of Canada. Only 1.5 percent of the Sarnia residents worked outside Canada, and it is likely that a significant proportion of these trips actually commute to the Detroit region rather than to Port Huron region in the United States. The discrepancy in work-related travel between the two areas is somewhat balanced by higher proportion of cross-border shopping and social-recreational travel, which account for almost 10 percent and 20 percent of total travel, respectively.

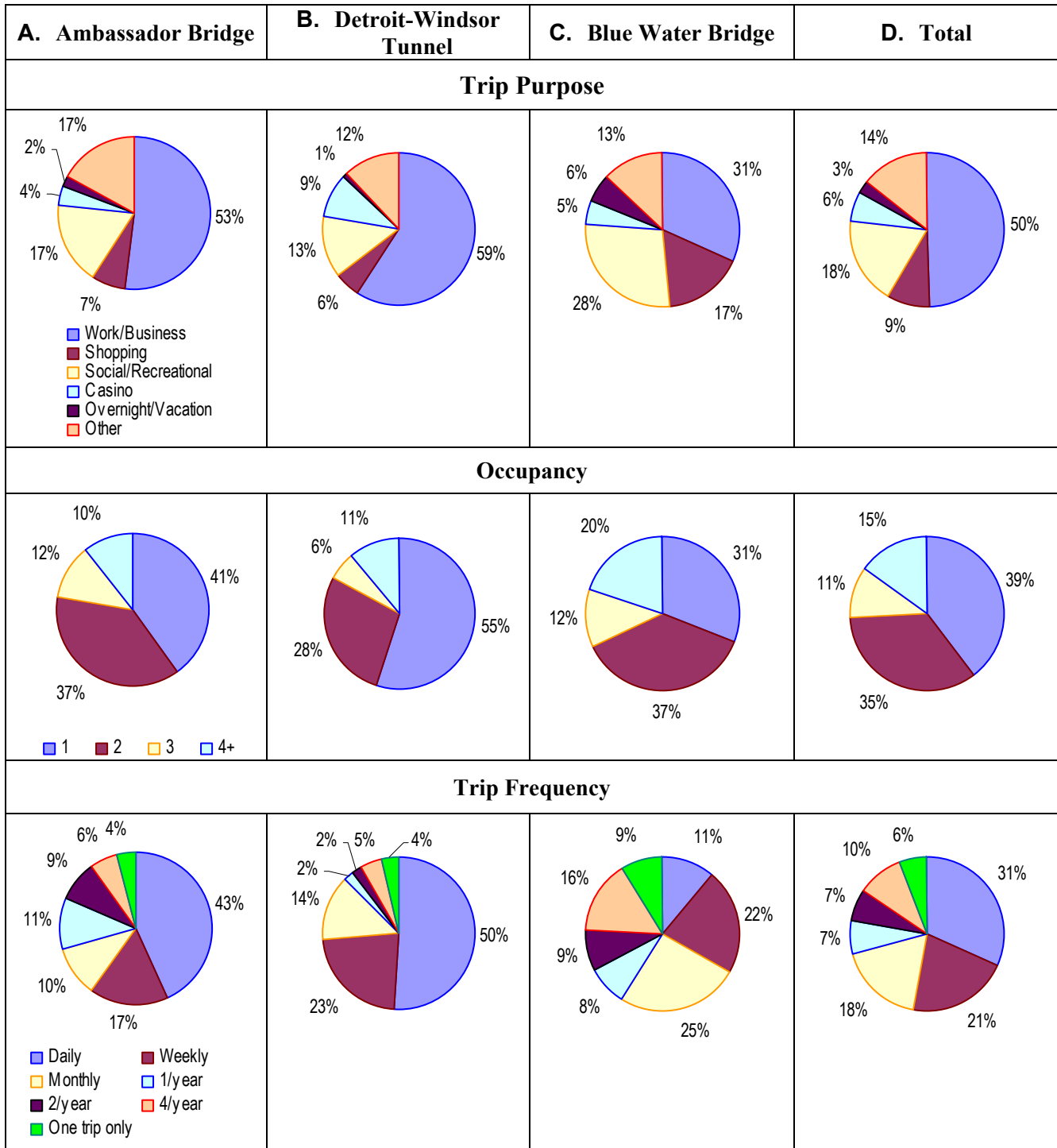

Figure 3-34. Weekday Passenger Car O/D Trip Characteristics

Despite the presence of three casinos in the Detroit region, the Canadian casinos in Windsor and Sarnia appear to still have a popular draw as a result of the tax-free winnings. The Windsor Casino is closest to the tunnel and was shown to draw a nearly 10 percent share of total daily traffic at the tunnel.

The use of the three crossings for longer-duration overnight vacation travel was shown to be less significant in April, after the March Break and before the summer vacation peaks. Travel for this purpose was however, most prominent at the Blue Water Bridge, likely due to the long-distance nature of this travel (allowing for greater flexibility in crossing choice), more scenic drives, less hectic drives, etc.

The occupancy (i.e., number of persons per vehicle) and trip frequency by crossing results were shown to be consistent with the travel pattern and purpose characteristics described above. The single-occupant vehicles typically associated with commuter work-related travel was the highest at the tunnel, while the multi-occupant vehicles from discretionary travel were more pronounced at the Blue Water Bridge. Similarly, daily trip frequencies from commuter travel patterns were highest at the tunnel and lowest at the Blue Water Bridge.

COMMERCIAL VEHICLE SUMMARY

Trip Distribution

Tables 3-18 and 3-19 show the proportion of trips using the travel origin-destination super zones, as outlined in Figure 3-33, for Ambassador Bridge and Blue Water Bridge, respectively. More disaggregate trip matrices captured from the commercial vehicle OD survey data from the 2006 National Roadside Survey (NRS) of commercial vehicles conducted by Transport Canada are presented in Appendix A.

Origin	Destination										Total
	1	2	3	4	5	6	7	8	9	10	
1 Detroit + NE Wayne						0%	1%	1%		2%	4%
2 Rest of Wayne Co.						0%	2%	1%		4%	8%
3 Port Huron/St. Clair Co.							0%				0%
4 Rest of SEMCOG						0%	1%	1%		1%	3%
5 Rest of Michigan							1%	0%		1%	3%
6 Other USA/Mexico	0%						5%	2%	0%	25%	32%
7 Windsor	1%	2%	0%	1%	1%	4%			0%		9%
8 Rest of Essex Co.	1%	1%	0%	1%	1%	2%					5%
9 Sarnia/Lambton Co.			0%			0%					0%
10 Other Ontario/Canada	2%	4%		2%	1%	29%					37%
Total	4%	6%	0%	4%	3%	36%	10%	4%	0%	34%	100%

Table 3-19
Weekday Commercial Vehicle OD Proportion of Trip Matrices - Blue Water Bridge

Origin	Destination										Total
	1	2	3	4	5	6	7	8	9	10	
1 Detroit + NE Wayne						0%	0%		0%	2%	2%
2 Rest of Wayne Co.						0%			0%	2%	2%
3 Port Huron/St. Clair Co.						0%			1%	3%	3%
4 Rest of SEMCOG						1%			0%	7%	8%
5 Rest of Michigan						2%			1%	10%	13%
6 Other USA/Mexico			0%	0%	0%	0%	0%		2%	27%	30%
7 Windsor						0%					0%
8 Rest of Essex Co.			0%		0%	0%					0%
9 Sarnia/Lambton Co.	1%	0%	1%	0%	2%	2%					5%
10 Other Ontario/Canada	1%	1%	2%	7%	10%	16%			0%		37%
Total	1%	2%	2%	8%	11%	21%	0%	0%	6%	49%	100%

The Ambassador Bridge was shown to service the vast majority of truck travel in the study area, carrying approximately 11,900 average daily weekday trucks. Given the strong industrial economies in both Detroit and Windsor (represented mainly by the automotive sector) and the ties between them, the Ambassador Bridge crossing serves a large number of local truck movements in addition to the long-distance through traffic more typical of international crossings. Twenty-one percent of the captured trips had a trip end in Wayne County and 28 percent have a trip end in Essex County, while approximately 9 percent of the overall crossing traffic is entirely between these areas.

Average weekday truck volumes on the Blue Water Bridge are less than half of the Ambassador Bridge at approximately 5,000 daily trucks. As Port Huron and Sarnia do not have the same industrial economies and ties as the Detroit-Windsor region, the proportion of local travel is significantly less and accounts for 6 percent of trips with a trip end in St. Clair County, 11 percent with an end in Lambton County, and only 1 percent of the overall crossing trips is entirely between these areas.

Just over half of the truck trips at the Ambassador Bridge are entirely long-distance through travel, while almost two-thirds of the truck trips at the Blue Water Bridge are entirely long-distance through travel. On the Canadian side, the truck trips are generated from the industrial nodes along the Québec-Windsor Corridor that is connected by Highway 401, and consists mainly of Montreal and the Greater Toronto Area regions. On the U.S. side, the truck trips are generated from a much broader distribution of places, concentrated in the Great Lakes states (of Ohio, Indiana, Illinois and Wisconsin) but also from as far away as Texas and California.

Less than 2 percent of these commercial vehicle trips had an origin and destination in the U.S. and are referred to as in-transit trips. The majority of these trips involve travel between Michigan and Western New York where the travel distance through Canada is

significantly shorter than traveling entirely within the U.S. via the routing south of Lake Erie. Approximately 3 percent of the truck traffic at the Blue Water Bridge was shown to be in-transit, compared to 1 percent at the Ambassador Bridge.

Traffic Characteristics

A summary of the distribution of weekday commercial vehicle volumes by commodity type and crossing is illustrated in **Figure 3-35**. The most common commodity type by volume is related to the auto industry with approximately 3,500 commercial vehicles daily, or 20 percent of all trips. The Ambassador Bridge carries almost 80 percent of the 3,500 daily auto industry related commercial vehicle trips among the three crossings. In addition to these, a large percentage of the almost 1,700 daily commercial vehicles carrying metal are also directly related to the auto industry.

Almost one-quarter of trucks crossing the border are not carrying any freight at all and are simply empty trucks en route to replenish their cargo. The proportion of empty movements is much higher than typical non-cross border movements as a result of the current U.S. Customs Service, U.S. Immigration and Naturalization Service and Citizenship and Immigration Canada laws and policies on cabotage, which restrict non-citizen truck drivers from picking up and hauling goods. Hence, for example, a Canadian truck driver may cross the border and deliver in the U.S., but might not be allowed to carry back cargo from the U.S. to Canada.

The border crossings generally carry a higher proportion of larger trucks than would be seen on a typical highway. The proportions of weekday vehicle configurations at each of the border crossings are shown in **Figure 3-35**. At the Ambassador and Blue Water Bridges, 90 percent of commercial vehicles are tractors with one trailer and 95 percent of all the commercial vehicles have at least one trailer.

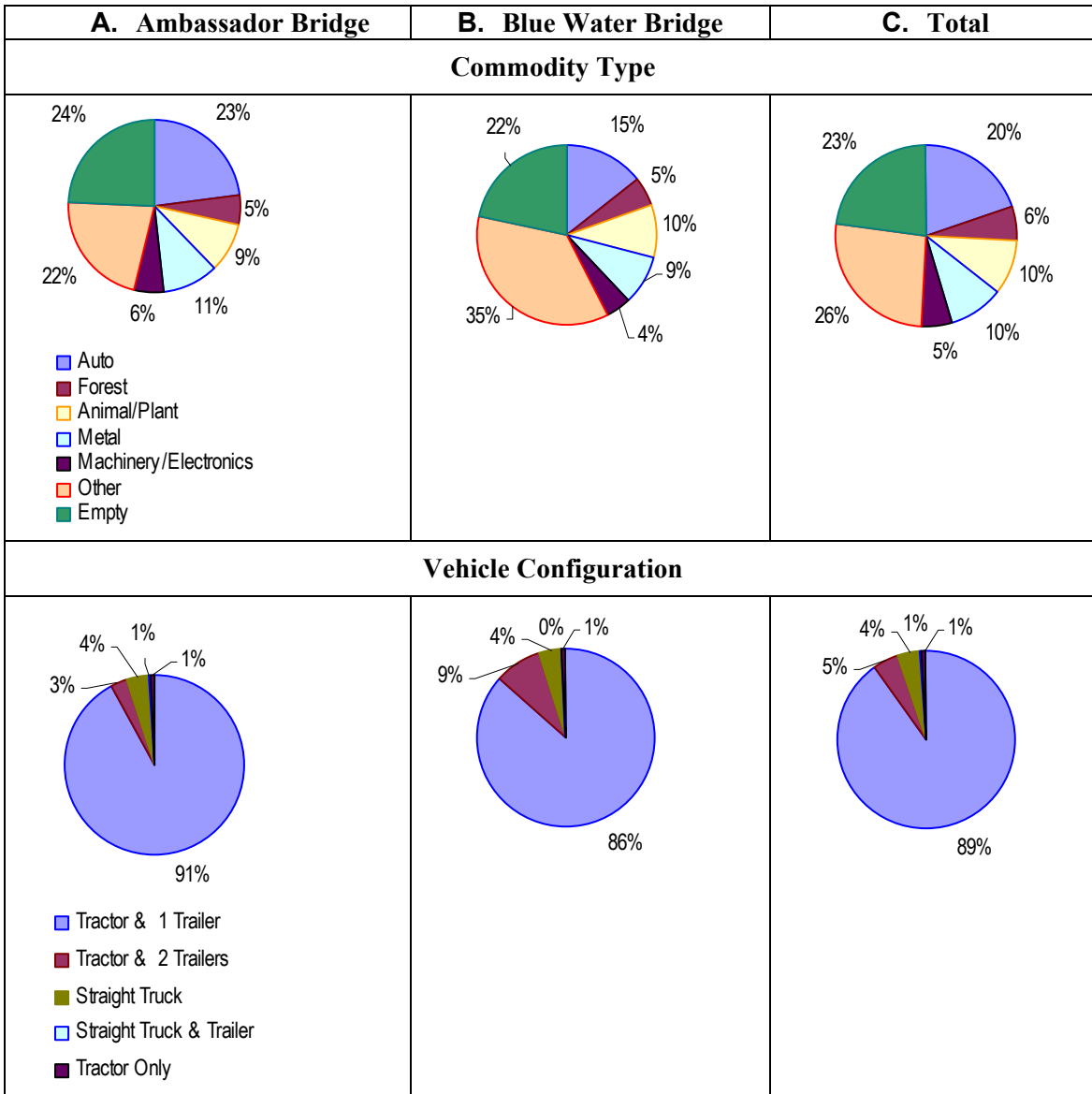

Figure 3-35. Commercial Vehicle Traffic Characteristics

STATED PREFERENCE SURVEY

Stated preference (SP) surveys are a crucial part of comprehensive traffic and revenue studies to estimate motorists' willingness-to-pay tolls for different types of trips and to capture additional factors that influence a traveler's decision to use one route over another. The surveys provide an important analytical tool in evaluating traffic and revenue potential and in enhancing the credibility of the study for presentation to the

financial community. The objective of this survey effort was to identify the major traveler behavioral patterns related to their route choice across the three existing crossings. This effort captured the respondents' willingness-to-pay tolls and identified and ranked the key factors that influence both local and long-distance passenger and commercial vehicle markets that currently use the existing crossings, for incorporation into the travel demand models.

The SP survey was conducted in the spring of 2008 for both the passenger car and commercial vehicle markets. The survey was implemented through a multiple-method sampling approach that included field intercept surveys using stand-alone laptop computers as well as over the internet via email distribution to targeted audiences. This section provides a summary of the survey implementation and survey results for passenger cars and commercial vehicles from the captured respondents. The commercial vehicle surveys were conducted on both commercial vehicle drivers and commercial vehicle decision makers. The survey for commercial vehicle decision makers was administered via email invitation, however, the survey responses was relatively low such that only the survey of commercial vehicle drivers is described in this section. The crossing choice model estimation that was developed and based on this survey effort will be discussed in Chapter 5, as part of the model development and validation. A more detailed description of the SP survey and the model estimation can be found in Appendix B.

PASSENGER VEHICLE SUMMARY

Survey Implementation

The survey was conducted via both field intercept survey and online survey techniques. Travelers who had used the Ambassador Bridge, the Detroit-Windsor Tunnel, or the Blue Water Bridge for a trip within the past month that was at least 15 minutes long, were recruited to take the automobile survey. The survey questionnaire was administered at numerous activity sites throughout the Detroit-Windsor area over an eleven day period, between 5 April 2008 and 15 April 2008, and 450 respondents completed the survey. The activity sites included locations in both Michigan and Ontario and were chosen to capture a diverse cross-section of the population in terms of both trip purposes and demographics.

Additional respondents were recruited to take the online survey by sending email survey invitations to those who were interested in participating in the survey and were identified through Survey Sampling International (SSI), an online email sample provider. Emails were also collected during the origin-destination survey. A total of 848 respondents completed the automobile survey during April 2008 for further incorporation into the analysis of passenger car crossing choice characteristics. **Table 3-20** summarizes the final sources of the survey respondents.

Passenger Car SP Survey Respondent Sources	
Respondent Source	Complete Surveys
Intercept at Activity Sites	450
Origin-destination survey postcard	105
Area businesses and universities	93
Email invitation to online panel members	200
Total	848

Survey Result Summary

Figure 3-36 provides the stated preference for motorists on their choice of crossings based on the captured respondent sample. Ambassador Bridge respondents were most likely to always select the new bridge option in the stated preference exercise compared to respondents who used the Detroit-Windsor Tunnel or Blue Water Bridge on their reported trips. Eighteen percent of Ambassador Bridge respondents always selected the new bridge whereas only 8 percent of Detroit-Windsor Tunnel respondents and 6 percent of Blue Water Bridge respondents did the same. The respondents from the Blue Water Bridge always selected their current crossing (the Blue Water Bridge) with considerably greater frequency than respondents who used the Ambassador Bridge or Detroit-Windsor Tunnel on their reported trips and accounted for forty-seven percent of Blue Water Bridge respondents. The Ambassador Bridge respondents who always chose this crossing under all scenarios only account for 9 percent of the overall respondent sample and 21 percent for Detroit-Windsor Tunnel respondents, as illustrated in **Figure 3-36**.

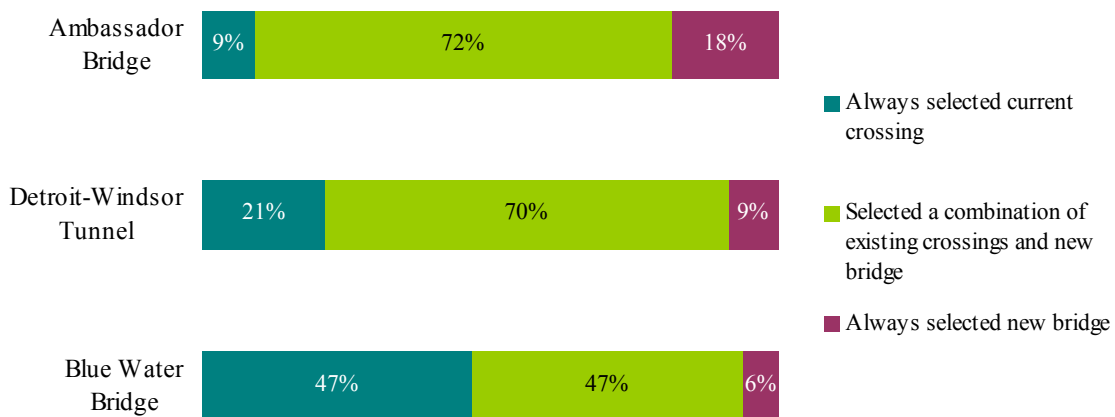

Figure 3-36. Passenger Car Stated Preference Behavior by Crossing

Two hundred thirty-nine (239) respondents out of 848 total respondents never selected the new bridge option in the stated preference exercise. The distribution of respondents' primary reason for never selecting the new bridge option is shown in **Figure 3-37**. The percentage distribution has been normalized to the total survey respondents of specific crossings. Approximately 15 percent of Detroit-Windsor Tunnel respondents and 34 percent of Blue Water Bridge respondents cited the convenience of their current route as the main reason for their aversion to the new bridge option. Approximately seven percent of Ambassador Bridge respondents selected the convenience of their current route as the primary reason for never selecting the new bridge. Another 8 percent of Ambassador Bridge respondents chose a lack of time savings relative to toll cost to explain why they never chose the new bridge, and several respondents also mention that the new bridge was too expensive (5 percent), compared to their current choice.

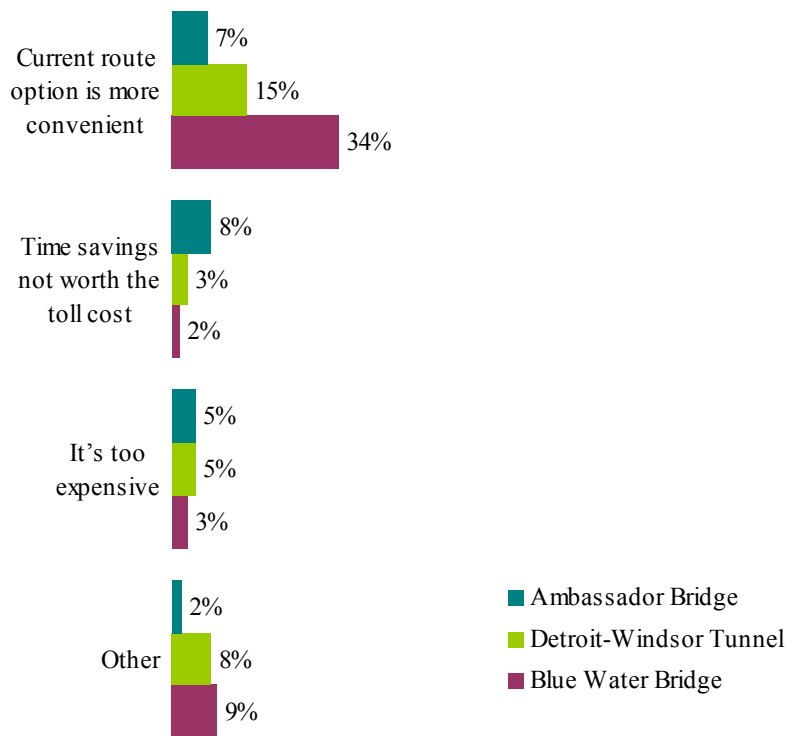

Figure 3-37. Primary Reasons of Passenger Cars for Never Selecting the New Bridge Option by Crossing

The remaining 609 respondents did select the new bridge option at least once in the stated preference exercise. The percentage distribution for the primary reasons why the new crossing was selected, as shown in **Figure 3-38**, has been normalized to the total survey respondents of each crossing. For all three crossings, the most commonly cited reason for selecting the new bridge option was its lower cost compared to the other options as was

captured in 37 percent of the Ambassador Bridge respondents, 38 percent of the Detroit-Windsor Tunnel respondents, and 27 percent of the Blue Water Bridge respondents. Faster travel times were another commonly reported reason for selecting the new bridge option with 16 percent of Ambassador Bridge respondents, 13 percent of Detroit-Windsor Tunnel respondents, and 11 percent of Blue Water Bridge respondents selecting this option, as shown in **Figure 3-38**.

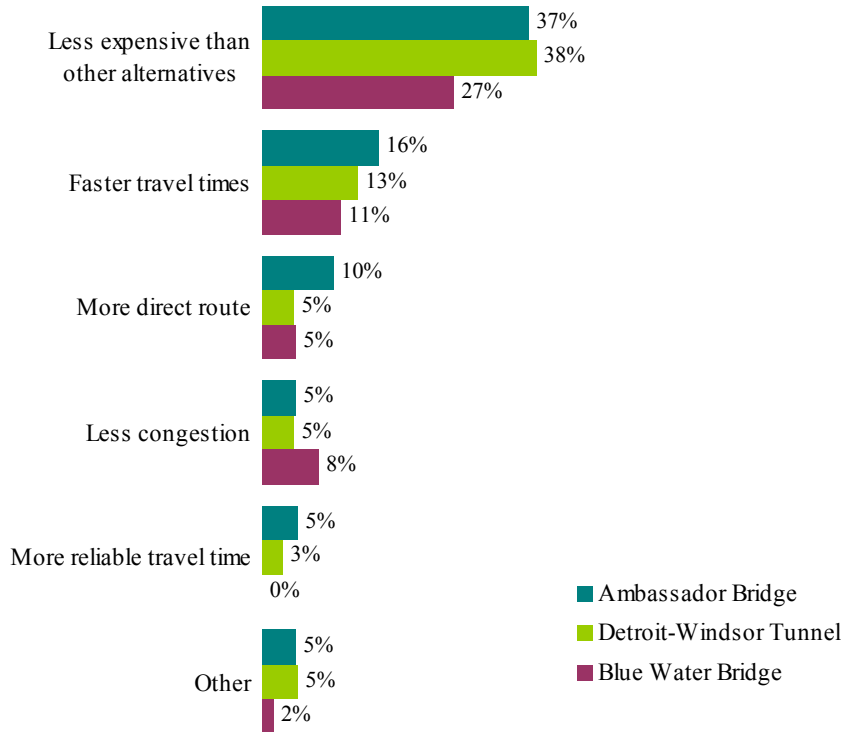

Figure 3-38. Primary Reasons of Passenger Cars for Selecting the New Bridge Option by Crossing

COMMERCIAL VEHICLE SUMMARY

Survey Implementation

The computer-based survey capture of the commercial vehicle travelers was administered through intercepts at several large truck stops and rest areas. Data collection for the commercial vehicles was conducted concurrently with the automobile survey between April 5 and April 15, 2008. Commercial vehicle drivers who had made a trip within the past month that was at least 15 minutes long and used either the Ambassador Bridge, Detroit-Windsor Tunnel, or Blue Water Bridge were recruited. Only those commercial drivers with some routing decision authority were surveyed.

Commercial vehicle drivers were intercepted at four large truck stops and one rest area strategically located north, south, east and west of the Detroit-Windsor area. The field sites were selected to ensure a high probability of intercepting drivers who were making trips within the corridor. Past survey experience showed that commercial vehicle drivers are a difficult population to survey and typically have very low response rates. To increase participation, a \$20 incentive was offered to each commercial vehicle respondent that completed the survey. A total of 293 commercial vehicle drivers completed the survey during the 11-day administration period.

Survey Results

The distribution of respondents' behavior in the stated preference exercise is summarized by crossing, in **Figure 3-39**. For those respondents who used the Ambassador Bridge, 13 percent exhibited an unwillingness to change their current behavior and selected the Ambassador Bridge every time. Thirty-four percent always selected the new bridge, and the remaining 53 percent selected a combination of the existing crossings and the new bridge. In comparison, Blue Water Bridge respondents expressed a stronger affinity for their current crossing with 39 percent selecting the Blue Water Bridge every time. Thirteen percent of respondents who used the Blue Water Bridge always selected the new bridge, and 48 percent selected a combination of the existing crossings and the new bridge.

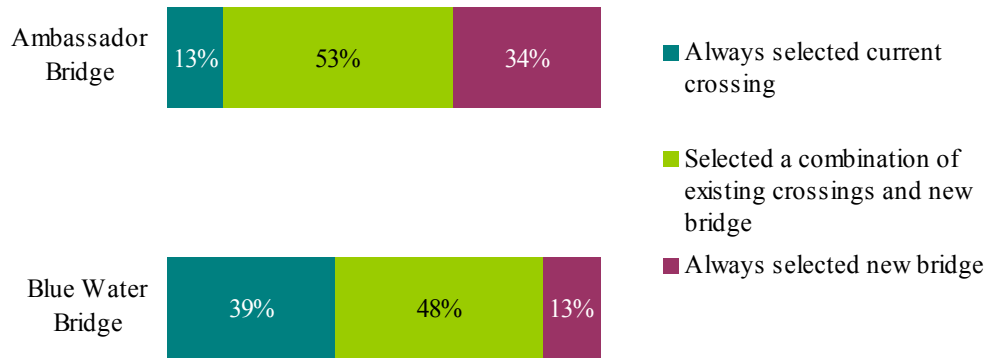

Figure 3-39. Commercial Vehicle Stated Preference Behavior by Crossing

Eighty-three (83) respondents (53 Ambassador Bridge and 30 Blue Water Bridge) out of the 293 total commercial vehicle survey respondents never selected the new bridge option in the stated preference exercise. **Figure 3-40** shows the distribution of the primary reasons for not selecting new crossing option. The percentage has been normalized to the total survey respondents. Twenty-eight (28) percent of Blue Water Bridge respondents never selected the new bridge because of the convenience of their current route. Seven (7) percent of Blue Water Bridge respondents indicated a lack of time savings relative to

cost as the primary reason they never selected the new bridge, and 6 percent reported “other” reasons. Only 4 percent of Ambassador Bridge respondents who never selected the new bridge cited the convenience of the current routes. Respondents in this segment were more likely to report high costs (9 percent) and a lack of time savings relative to cost (7 percent) as their primary reasons for never selecting the new bridge, as shown in **Figure 3-40**.

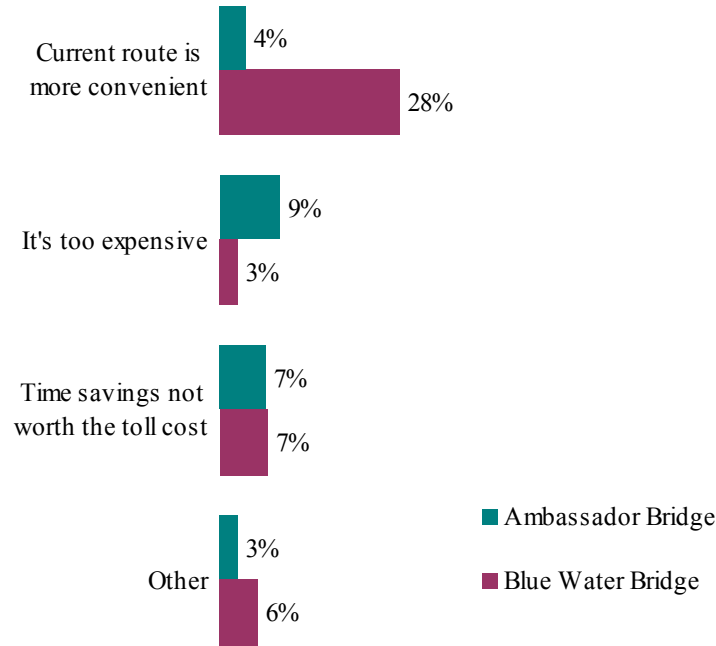

Figure 3-40. Primary Reasons of Commercial Vehicles for Never Selecting the New Bridge Option by Crossing

Two-hundred and ten respondents out of the 293 total survey respondents did select the new bridge option at least once in the stated preference exercise. **Figure 3-41** shows the distribution of these respondents’ primary reasons for doing so by crossing. The percentage has also been normalized to the total survey respondents. Across both crossings, faster travel time was the most commonly reported reason for selecting the new bridge option. Thirty-four (34) percent of Ambassador Bridge respondents and 27 percent of Blue Water Bridge respondents chose this reason.

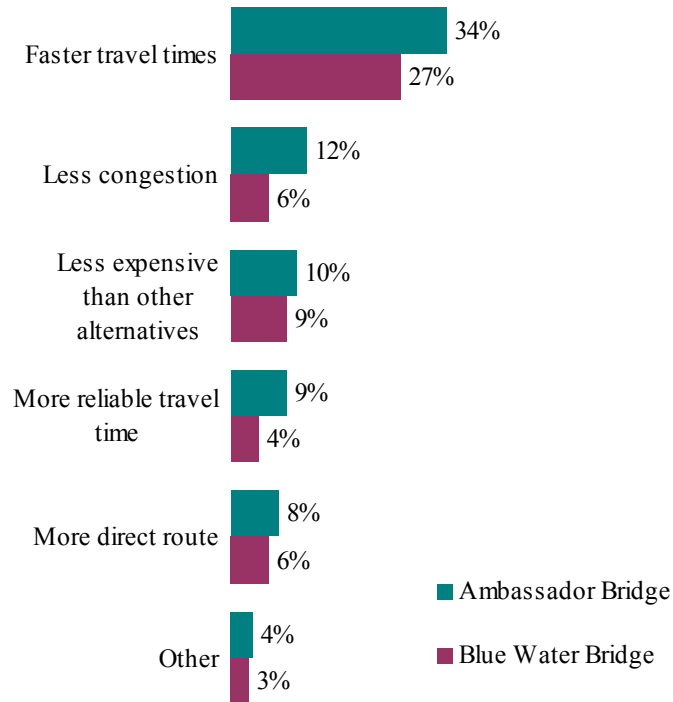

Figure 3-41. Primary Reasons of Commercial Vehicles for Selecting the New Bridge Option by Crossing

CHAPTER 4

CORRIDOR GROWTH ASSESSMENT

A detailed review of the socioeconomic characteristics of the key markets served within the Detroit-Windsor region were investigated and summarized in the following chapter. The projection of these socioeconomic variables is an important component that is used to develop the future traffic model databases and will influence the future toll feasibility potential of the new Detroit International River Crossing (DRIC). Comprehensive socioeconomic data was collected from multiple sources and was reviewed and compared to the model databases that were developed from previous DRIC studies. This was undertaken for purposes of determining the growth of future local demand that influences the local congestion patterns, as well as the local and national border crossing markets. An independent economic consultant, Centre for Spatial Economics (C4SE), was consulted to provide a detailed and independent review of the most recent socioeconomic forecasts for the Detroit-Windsor region, as described in Appendix C.

The multiple markets served by the existing border crossings required that the historical and future socioeconomic trends be evaluated not only at the corridor level, but also at the regional, state and national levels. The chapter begins with an overall summary of the current trends within the local economies and the key macroscopic economic variables for the United States and Canadian economies. These key variables include growth trends in the border crossing demand, national trade trends, gross domestic product growth, and the current exchange rate trends, all of which influence the border crossing demand. A detailed review of the local socioeconomic development patterns is then provided with further focus on the local key variables of population, employment and income growth within the Detroit and Windsor regions. This analysis provides a summary of the forecasted intensity from the local perspective and magnitude of local socioeconomic growth expected within the study corridor over the projection period.

As part of this corridor growth assessment, a comparison is also made between various demographic sources to provide a perspective on the ranges of forecasts that have been developed by the numerous agencies. A detailed description at the local traffic analysis zone level is then provided to highlight the geographic distribution of the regional growth to the specific local regions.

The independent economic assessment provided a detailed comparison between the various studies and outlined key changes in the forecast assumptions that resulted from the assessment. The analysis focused primarily on the overall frontier corridor growth within the Detroit-Windsor region at a macroscopic level to account for the national and global variables that will likely affect the future border crossing demand. The demographic growth projections from the Planning/Need & Feasibility (P/N&F) Study in 2000 and later updated projections as part of the Detroit River International Crossing Environmental Impact Study (DRIC-EIS) in 2004 are referenced as part of this comparison. In addition, the forecasts developed as part of the previous Transport Canada comprehensive economic review that was completed in March 2008, prior to the significant global and national economic turmoil, were consulted and reevaluated.

REGIONAL ECONOMIC GROWTH

ECONOMIC BASE AND TRENDS

The regional growth within the Detroit-Windsor area is, to an extent, dependent on the forecasted macroscopic growth within the respective province and state. An evaluation of the historical and projected provincial and state population trends is provided in **Figure 4-1** from several sources and highlights the growth of the Centre for Spatial Economics (C4SE) modified forecasts that were used as the baseline. Historically, Michigan grew at an average annual rate of just over 0.4 percent between 1996 and 2008, based on Census, and the C4SE forecasts for the Michigan economy reflects a negative outlook in the short-term between 2008 and 2010, with very modest growth expected over the next 20 years thereafter. The population in the Province of Ontario has historically grown at an average annual rate of 1.3 percent between 1990 and 2008, according to Statistics Canada, and is projected by C4SE to continue to grow at an average annual rate of 1.1 percent between 2008 and 2030. The total population in 2008 was over 12.9 million in Ontario and was expected to reach 13.1 million in 2009, and over 10.0 million in Michigan which is expected to show a decline to 9.97 million in 2009.

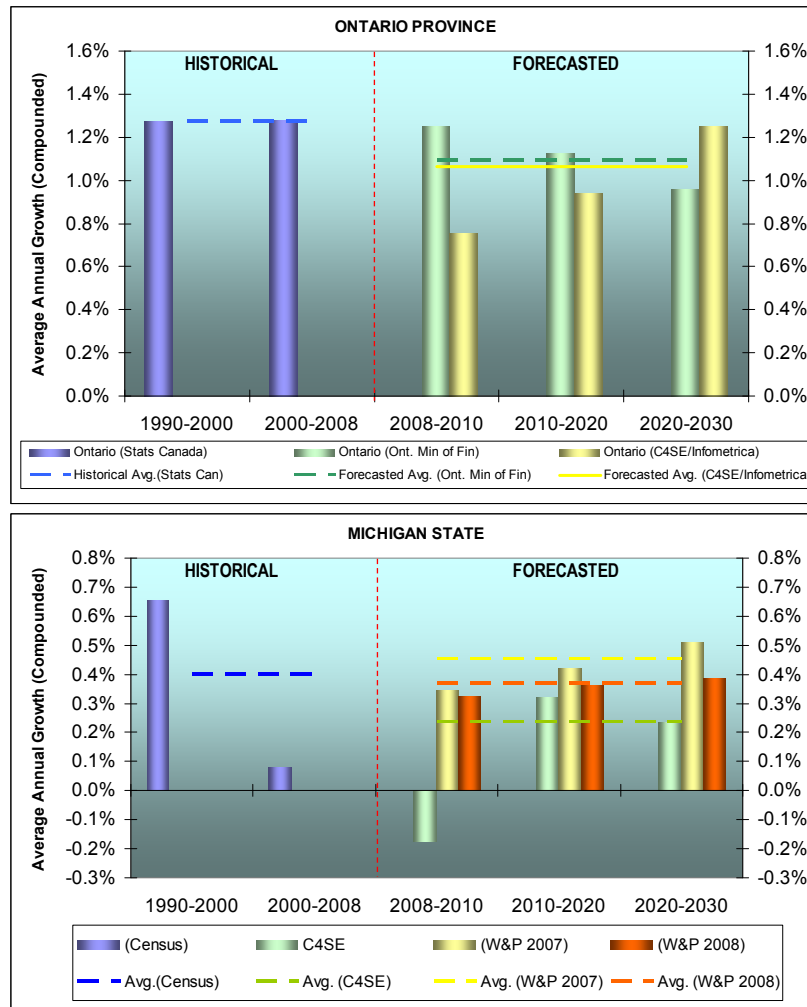

Note: Ontario Ministry of Finance (Ont. Min. of Fin.) projections are only through 2025

Figure 4-1. Historical and Projected Regional Population Trends

An evaluation of the historical and projected provincial and state employment trends is provided in **Figure 4-2** and demonstrates that employment in the state of Michigan has historically grown at an average annual rate of just over 0.9 percent between 1996 and 2006 based on Census, and the C4SE is projecting a negative outlook in the short-term between 2008 and 2010, which results in an average annual growth rate of - 0.3 percent annually between 2008 and 2030. The employment in the Province of Ontario has historically grown at an average annual rate of 1.4 percent between 1990 and 2006, according to Statistics Canada, and the C4SE forecasts show that employment will continue to grow at an average annual rate of 1.5 percent between 2008 and 2030. The total employment in 2008 (by place of work) was over 5.7 million in Ontario and over 5.3 million (BEA Employment definition) in Michigan.

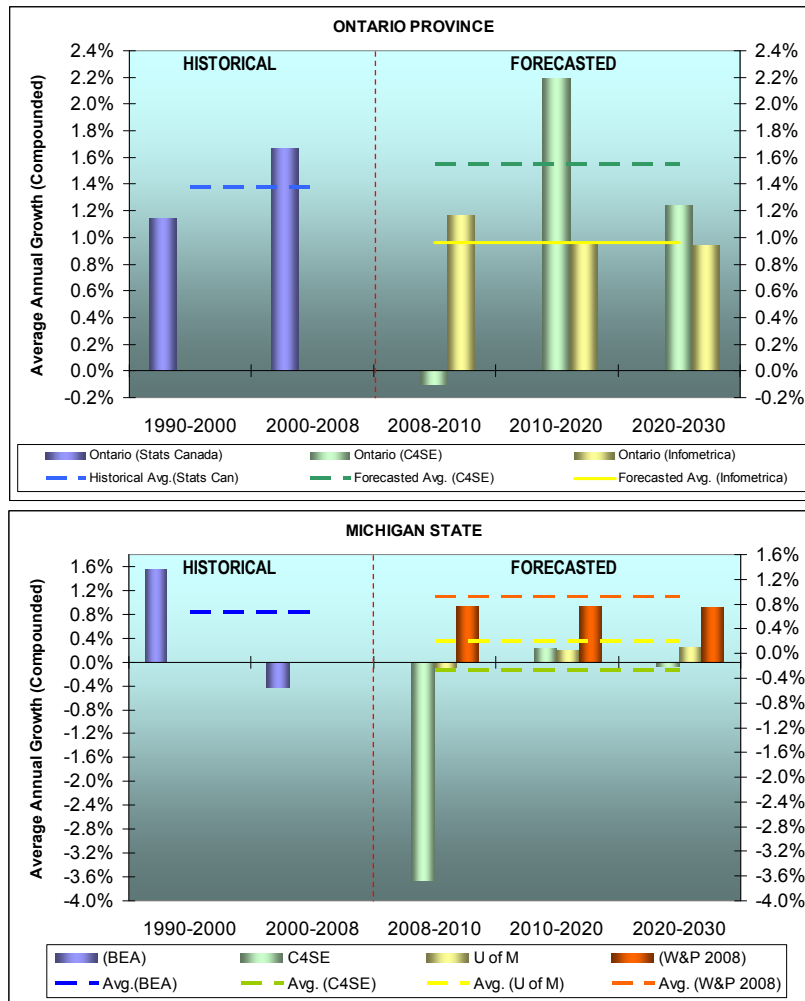

Note: C4SE reflects Independent assessment by Centre for Spatial Economics

Figure 4-2. Historical and Projected Regional Employment Trends

KEY TRADE RELATIONSHIPS

The flow of goods, services, and capital between the United States and Canada is the largest bilateral trading relationship between any two nations in the world. Since the enactment of the 1989 Canada-U.S. Free Trade Agreement (FTA) and the subsequent North American Free Trade Agreement (NAFTA), trade between the U.S. and Canada has grown by more than 245 percent from \$243 billion in 1994 to \$596.9 billion in 2008¹. Due to the economic down turn in 2009, trade between the United States and Canada has in fact been affected such that the year-to-date (September 2009) showed that the trade value was \$311 billion (USD), compared to the year-to-date (September 2008) trade value of \$472 billion, which indicates a 34 percent decrease in year-to-date trade between

¹ U.S. Bureau of Transportation Statistics

2008 and 2009². Canadian trade historically accounted for approximately 20 percent of the overall U.S. trade, and was the first ranked country in exports and second ranked country in imports in 2008 and year-to-date 2009.

In 2009, the Detroit-Windsor border crossings – specifically, the Ambassador Bridge, Detroit-Windsor Tunnel, and Blue Water Bridge – carried over 11.2 million cars and 3.7 million commercial vehicles, representing over 45 percent of all United States-Canada total border crossing traffic that is tracked by the Public Border Operators Association (PBOA) and over 61 percent of all cross-border commercial vehicle trips³. This activity at the Detroit and Port Huron crossings represents an estimated \$202 billion (USD) in Canada/United States surface trade (72 percent of which is truck related i.e. \$145 billion (USD)). The September 2009 year-to-date value of trade between the United States and Canada is shown as having diminished significantly from historic levels. The September year-to-date Detroit international crossings trade values were 65 percent of the 2008 levels and 74 percent for the Port Huron crossing. The economic activity generated from this trade directly effects many jobs in the Province of Ontario and the State of Michigan (the U.S. International Trade Administration estimates that approximately 7 percent of U.S. jobs are tied to the export of manufactured goods, which translates to millions of jobs).

Canada is ranked as the leading exporter to the United States and is also a leading export market for over 35 of the 50 U.S. states. The traded value across the U.S.-Canada border has historically ranged between \$1.2 and \$1.9 billion (USD) daily, and over 40 percent of this trade traverses the Detroit-Windsor crossings. The automotive industry-related trade between the United States and Canada historically amounted to 20 percent of this overall trade value at the Detroit-Windsor crossings, and 30 percent of the overall local Detroit-Windsor crossings (excluding the Blue Water Bridge). Much of the automotive cross-border traffic is driven by the presence of the symbiotic relationship that the automotive industry has within Detroit and Windsor, with several plants located on either side of the border for the automotive giants such as Chrysler, General Motors and the Ford Motor Company. Michigan is the top trading partner with Canada and accounted for over 67 billion (USD) in trade in 2008 (trade that has an origin or destination in the state), and 72 percent of the truck freight trade value at the Detroit-Windsor crossings had an origin or destination outside of Michigan⁴. The Detroit-Windsor crossing trade is estimated to support over 7.1 million jobs in the United States and over 220,000 jobs within Michigan. In Canada, the crossing trade historically supported over 3 million jobs in the Windsor region and Canada combined. **Figure 4-3** provides a historical summary of the U.S./Canada trade value that is currently traversing the Port Huron and Detroit border

² U.S. Department of Commerce, Census Bureau, Foreign Trade Division

³ Public Border Operators Association (PBOA)

⁴ Source; Federal Highway Administration, March 23, 2006

crossings. Trade values have continued to trends upward since 2003 and began declining in 2008, which in part may be a result of the economic downturn.

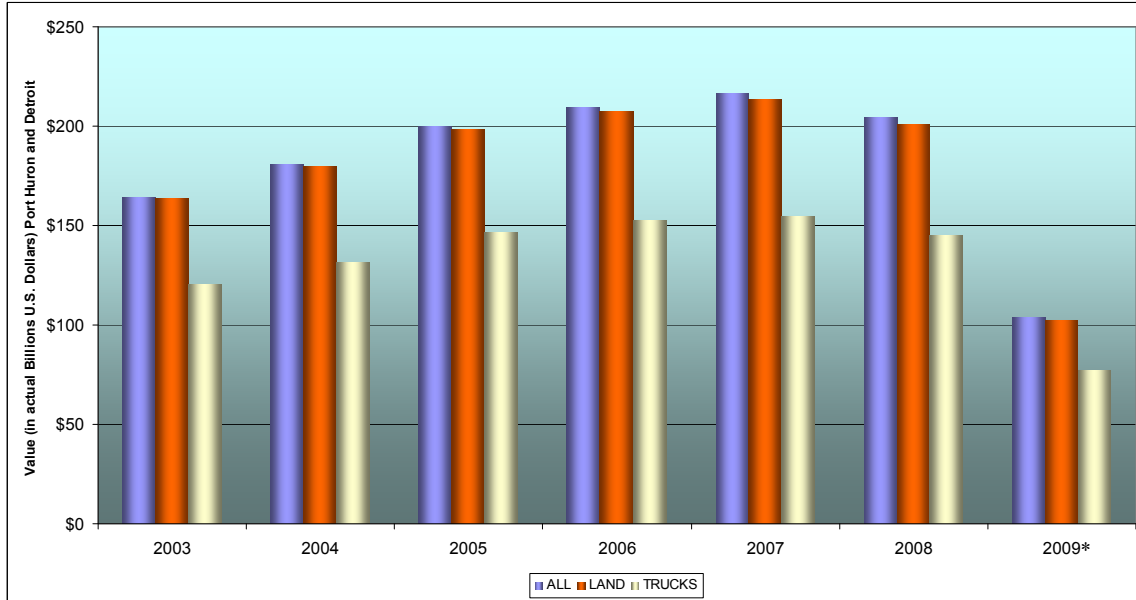

Sources: U.S. Department of Transportation, Research and Innovative Technology Administration, Bureau of Transportation Statistic, TransBorder Freight Data.

*Note: 2009 reflects year-to-date (September)

Figure 4-3. Historical U.S./Canada Trade Value Trends (Port Huron and Detroit)

GROSS DOMESTIC PRODUCT TRENDS

The past decade has experienced both extremes of the economic spectrum – from unprecedented growth to economic recession. While the early 1990’s saw the tail-end of a period of economic stagnation, the years following gave rise to rapid economic expansion that lasted through mid-2000. From late 2000 to early 2001 the U.S. economy began a downward slide, further compounded by global events such as the terrorist attacks of September 11th, 2001, and the subsequent war in Iraq. Closely linked to the U.S. economy, the Canadian economy showed a similar trend.

The regional traffic growth around the Detroit-Windsor area is, to an extent, dependent on the national and statewide growth. These both influence trade flowing through the Detroit-Windsor crossing that is typically destined to regions outside the immediate vicinity of the border crossings. An evaluation of the historical and projected Gross Provincial/State Product (GSP) and national Gross Domestic Product (GDP) is provided in **Figure 4-4** and demonstrates that the Gross State Product of Michigan has historically grown at a real average annual rate of 1.2 percent between 1996 and 2008, based on the Bureau of Economic Analysis, although between 2000 and 2008 the Gross State Product exhibited negative real growth. The Gross State Product in Michigan is, according to

Woods and Poole Complete Economic and Demographic Data Source (2008 CEDDS), expected to grow at a real average annual growth rate of 1.8 percent annually between 2008 and 2030 (however these projections do not take into account the more recent economic turmoil). The Gross State Product in the Province of Ontario has historically grown at a real average annual rate of 2.6 percent between 1990 and 2008 and is projected to continue to grow at an average annual rate of 2.4 percent between 2008 and 2030, based on the Conference Board of Canada projections and 2.9 percent based on the Centre for Spatial Economics projections. The Gross State Product in 2008 was over \$531.6 billion (2002 CAD) in Ontario and over \$326 billion (2000 USD) in Michigan.

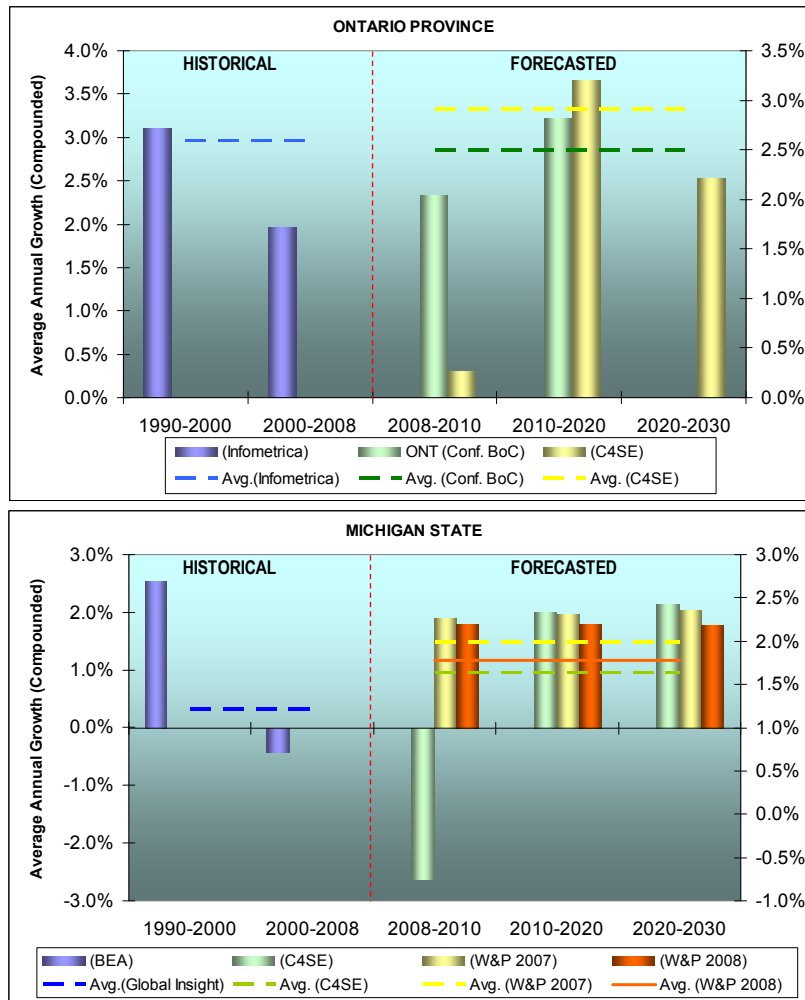

Sources: Conference Board of Canada (Conf. BoC), Infometrica, Centre for Spatial Economics (C4SE), Global Insight, CEDDS Woods and Poole (W&P)

Figure 4-4. Historical and Projected Regional Gross State Product Trends

HISTORICAL GROWTH TRENDS

BORDER CROSSING TRENDS

The border crossing automobile traffic has been continuously decreasing since 1999 with an almost 37.1 percent reduction in the total United States-Canada border crossing traffic currently tracked by PBOA in 2009, compared to the peak in 1999/2000, as shown in **Figure 4-5**. The passenger vehicle crossings have experienced the greatest decline of close to 31.1 percent between 2000 and 2008, with the greatest declines occurring between 2000 and 2003. In contrast, the commercial vehicles showed only moderate declines prior to 2003; however, they have since begun to experience declines that are just as significant as the passenger border crossing declines. The year-to-date (November) data indicates that the commercial border crossing traffic decline in 2009 is close to 18.5 percent which, for the first time since 2000, is now for two consecutive years, exceeding the decline in passenger traffic on a percentage basis.

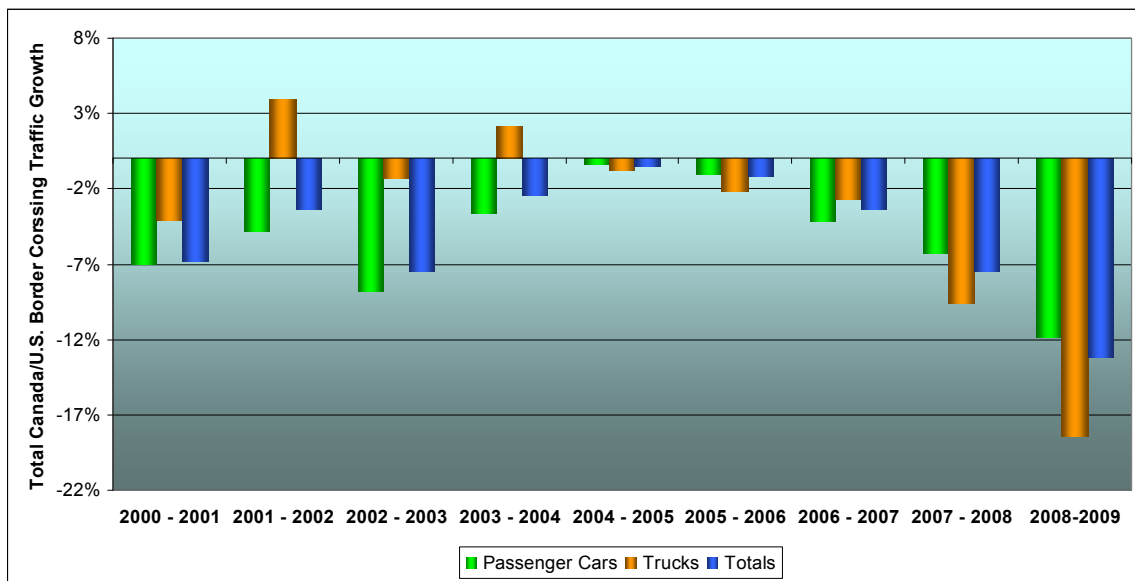

Source: Public Border Operators Association (PBOA) 1999-2009

Figure 4-5. Historical Total PBOA Border Crossing Trends

The overall PBOA tracked U.S./Canada border crossing traffic at its peak in 2000 was over 52.5 million total vehicles (8.5 million of which were commercial vehicles), and the three crossings in the Windsor/Sarnia region accounted for over 5.2 million commercial vehicles. This overall PBOA U.S./Canada border crossing traffic, more recently in 2009, was over 33.0 million total vehicles (6.1 million of which were commercial vehicles), and the three crossings in the Detroit/Port Huron region accounted for over 3.7 million commercial vehicles. The reduction in border crossing can be attributed to several

nationwide occurrences over the last nine years, some of which are described in subsequent sections below.

NATIONAL VEHICULAR TRAFFIC DEMAND TRENDS

The national recessionary trend for both countries on either side of the border, as well as many other economies globally, is the most recent phenomenon that has affected the overall passenger and commercial vehicular demand. The traffic in 2001, prior to the events on 9/11, had shown signs of a decline as a result of the economic downturn that was already underway at the time, such that following the events on 9/11, the downward trend continued, perpetuating the decline in traffic further during the 2001-2003 timeframe. Until then the economies were shown to be growing at a steady pace, however, other influential factors aside from economic growth were also shown to be contributing to the decline of traffic demand at various border crossings.

The overall vehicle miles traveled (VMT) in the United States showed signs of decline between 2006 and 2007, after steady increases for over a decade which, to an extent, can be attributed to the current economic downturn. The traffic demand at the national level, as monitored by the Federal Highway Administration (FHWA), has shown recent declines in total VMT following an upward trend since the 1980’s. This trend has a tendency to erode the current congestion along most routes and is somewhat indicative of the overall statewide vehicle usage trend. The year-to-date (November) VMT trends in Michigan declined by over 2.5 percent between 2007 and 2008. More recently, declines have slowed but lags behind the U.S. trends which shows a slight positive increase, as shown in **Figure 4-6**.

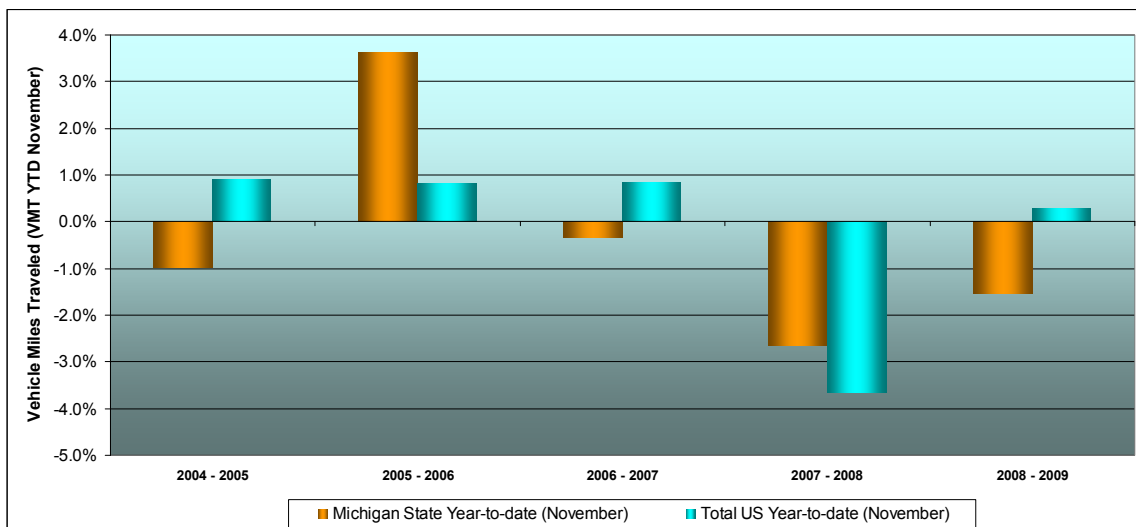

Source: Federal Highway Administration - Traffic Volume Trends

Figure 4-6. Historical Vehicle Miles Traveled Growth Trends

FUEL PRICE VOLATILITY AND TRENDS

The effect of the decline in traffic is not only influenced by the current economic turmoil but the fluctuation in fuel prices that also occurred over the last ten months in 2008. A Congressional Budget Office Report titled “Effects of Gasoline Prices on Driving Behavior and Vehicle Markets,” January 2008, cited evidence that the increases in gasoline prices can cause a decline in freeway traffic nationwide to the extent that every 50 cent increase results in a 0.7 percent decline in vehicular traffic on freeway facilities across the nation. This effect is certainly evident nationwide and Michigan is no exception. The volatility of fuel prices, more specifically, has the potential to impact the longer distance and commercial vehicle travel demand over the near and long-term in Michigan. **Figure 4-7** highlights the trends of fuel prices in the Detroit region (Michigan and U.S. averages were shown to be very similar), the Province of Ontario average and the Canadian average over the last two years.

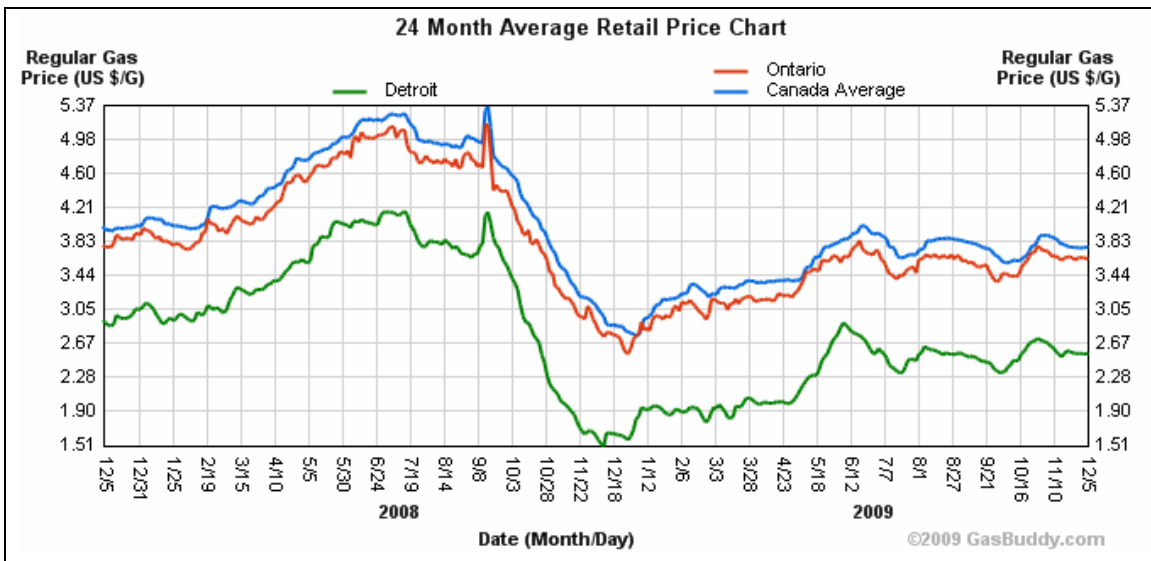
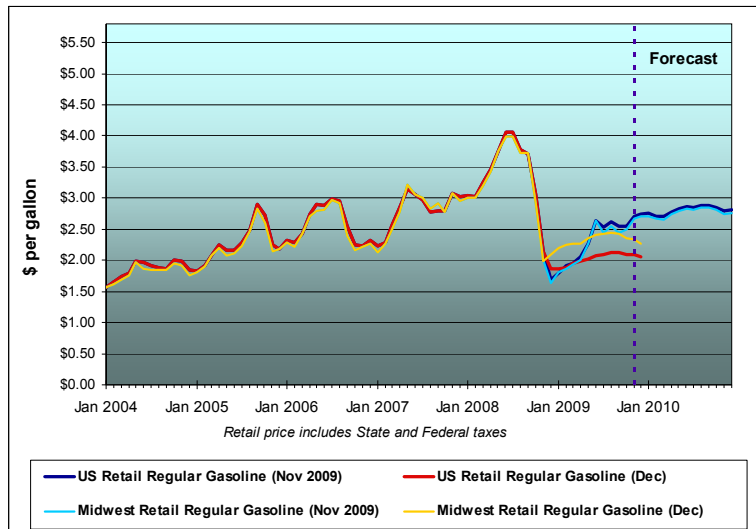

Figure 4-7. Historical Average Retail Fuel Prices Trends

As expected, the historical trend shows the drastic increase in fuel prices that began in 2006 and had remained somewhat stable through most of 2007. In March 2008 the fuel prices began to increase at an exponential rate and peaked in July at close to \$4.21 per gallon in Detroit. Since July 2008, the fuel prices have dropped drastically back down to levels not seen since 2006, and have remained flat at around \$2.60 per gallon. The rapid decline is, in part, a result of the current U.S. and global economic downturn that has dampened the global energy demand for gasoline, as a result of the contracting markets and economies. The peaking of fuel prices during the summer certainly had an impact on 2008 vehicular demand, especially for the recreational and discretionary travel markets in most states. The diverse markets serviced by the border crossing traffic, including the

intercity/rural and urban markets, and their differing sensitivity to gasoline price fluctuations, certainly had an effect on the overall border crossing demand, as reflected by the recent trends at most border crossing facilities.

The 2009 short-term energy outlook for retail regular gasoline in the Midwestern States and nationally is shown in **Figure 4-8**. The November short-term outlook for 2009 shows a drastic downward trend, with fuel prices stabilizing within the \$2.50 - \$3.00 per gallon range, which is slightly higher than the projections made last year in December.



Source: Short-Term Energy Outlook, EIA, November 2009

Figure 4-8. Historical and Projected Gasoline and Oil Trends

FOREIGN EXCHANGE RATE TRENDS

The Canadian dollar has appreciated significantly against the U.S. dollar since 2000 and continued until 2008, when the two currencies reached parity, as shown in **Figure 4-9**. For several months in 2008 the strength of the Canadian currency in fact exceeded that of the U.S. currency. These shifts in exchange rates affect the various border crossing markets in different ways and the recent parity of the two currencies made the Canadian recreational activities somewhat less attractive to U.S. residents, while the rising Canadian dollar made the shopping in the United States more attractive due to the current sales tax disparities between Michigan and Ontario.

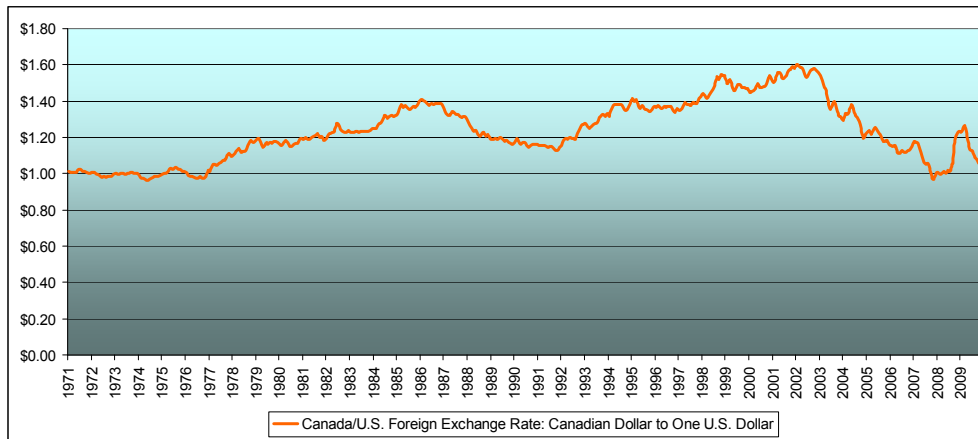

Source: Bank of Canada

Figure 4-9. U.S./Canada Foreign Exchange Rate Trends

In the later months of 2008 and in early 2009, the U.S. currency gained strength but has again begun approaching parity such that the current rate (November 2009) is approximately \$1.06 (CAD) for one U.S. dollar. The fluctuations in the currencies has most likely affected several of the border crossing markets between 2000 and 2009 and have, in part, contributed to some of the observed declines in border crossing demand. The Windsor economy is also very dependent on the gaming/tourism industry, which is somewhat affected by the exchange rates between the United States and Canada.

ADDITIONAL INFLUENTIAL FACTORS

Several additional factors that undoubtedly have contributed to the declines between 2000 and 2008 include:

- *Unforeseen events:* The terrorist attacks of September 11, 2001, the wars in Iraq and Afghanistan, and the SARS outbreak in the Toronto area in 2003 affected travel demand at the border crossings, and placed some additional barriers to the seamless economic/trade interaction between the United States and Canada;
- *Immigration and State/Provincial Policies:* The occurrence of the 9/11 attacks led to the United States establishing more stringent policies on immigration and customs that included the establishment of the Western Hemisphere Travel Initiative. The Western Hemisphere Travel Initiative (WHTI) was developed by the departments of State and Homeland Security as a result of recommendations made by the 9/11 Commission and was passed into law under the Intelligence Reform and Terrorism Prevention Act by Congress in 2004. The initiative requires all persons crossing the border to have a passport or another accepted document that establishes the bearer's identity and nationality when entering or departing the United States from within the Western Hemisphere. The WHTI

became effective on June 1st, 2009, resulting in some significant drops in recreational demand at local business (restaurant and bars) and hotels within Windsor and to the border crossing traffic demand. State and local laws, such as the Sunday closing laws in Ontario, or trade policies that reduced duties and tariffs on consumer items, can also influence the composition of demand across the various border crossings.

- *Localized Impacts:* The opening of key recreational establishments such as casinos, restaurants/bars, and bingo halls, affects the directional distributional characteristics of border crossing demand. Changes in policies or the operation of these establishments can cause shifts in the border crossing demand for their respective markets, which in some cases can be a contributing portion of the overall demand.

THE DETROIT REGIONAL ECONOMY

The following section provides a more detailed review of the historical and projected trends of the local and United States economies, and the socio-economic characteristics within the study area and around the existing crossings in the Detroit and Port Huron regions. The city of Detroit, located in Wayne County (southeastern Michigan), is surrounded by seven other counties that make up the Southeast Michigan Council of Government (SEMCOG) boundaries. These seven counties within SEMCOG include:

- Wayne County (the anchor for the city of Detroit and the was historically the main manufacturing center within Michigan);
- Monroe County;
- Washtenaw County;
- Livingston County;
- Oakland County;
- Macomb County; and
- St. Clair County.

The socioeconomic forecasts used for the 2008 comprehensive study were obtained from Southeast Michigan Council of Governments (SEMCOG) for the 2030 Regional Transportation Plan (RTP). The most comprehensive geographic detail for the 234 municipalities located within the seven counties comprising the SEMCOG region for the 2005 to 2030 time horizon⁵ were obtained for review as part of the study. The socioeconomic forecasts were revisited and updated based on readily available data from the 2035 RTP and the results of the update are presented along side the initially developed forecasts. The various socioeconomic forecasts were consulted in the

⁵ SEMCOG has developed updated forecasts for the stated socioeconomic variables, extending through 2035, however, this information was only available at the county levels at the time of the study.

development of the local traffic analysis zones (TAZ) within each respective region, and **Figure 4-10** illustrates the county boundaries within the SEMCOG region.

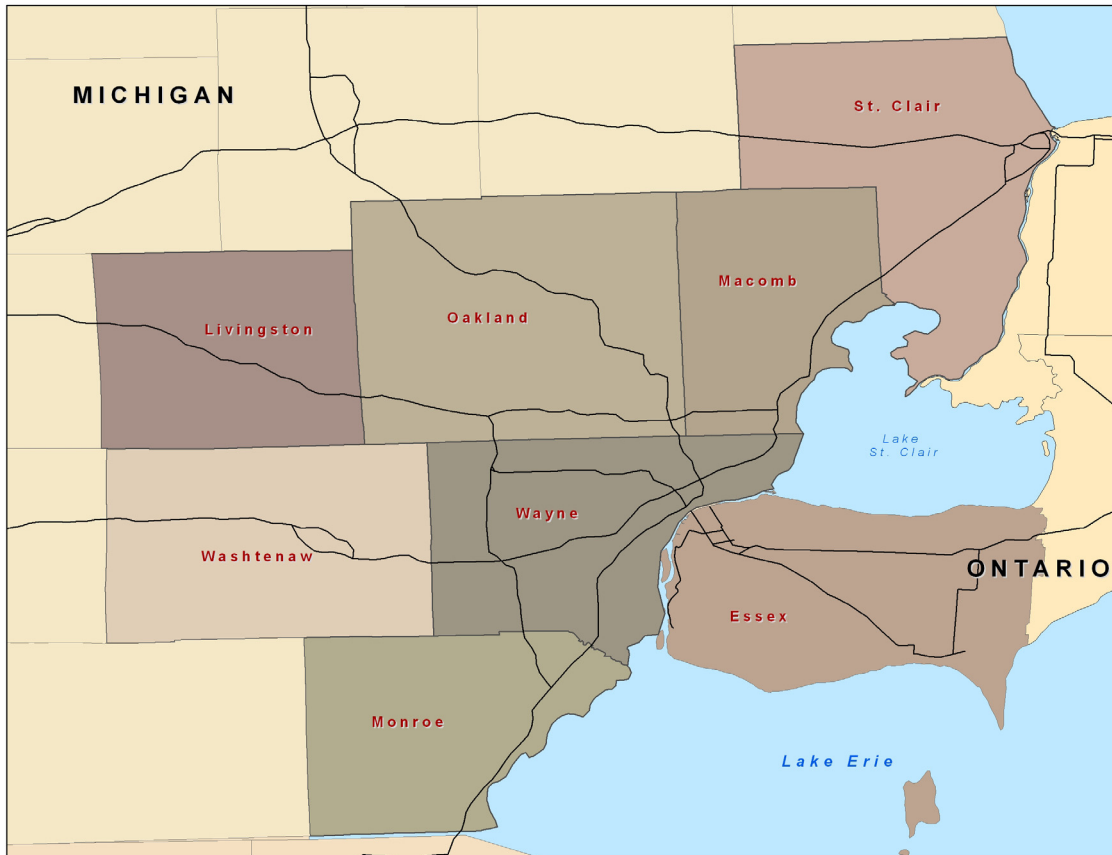
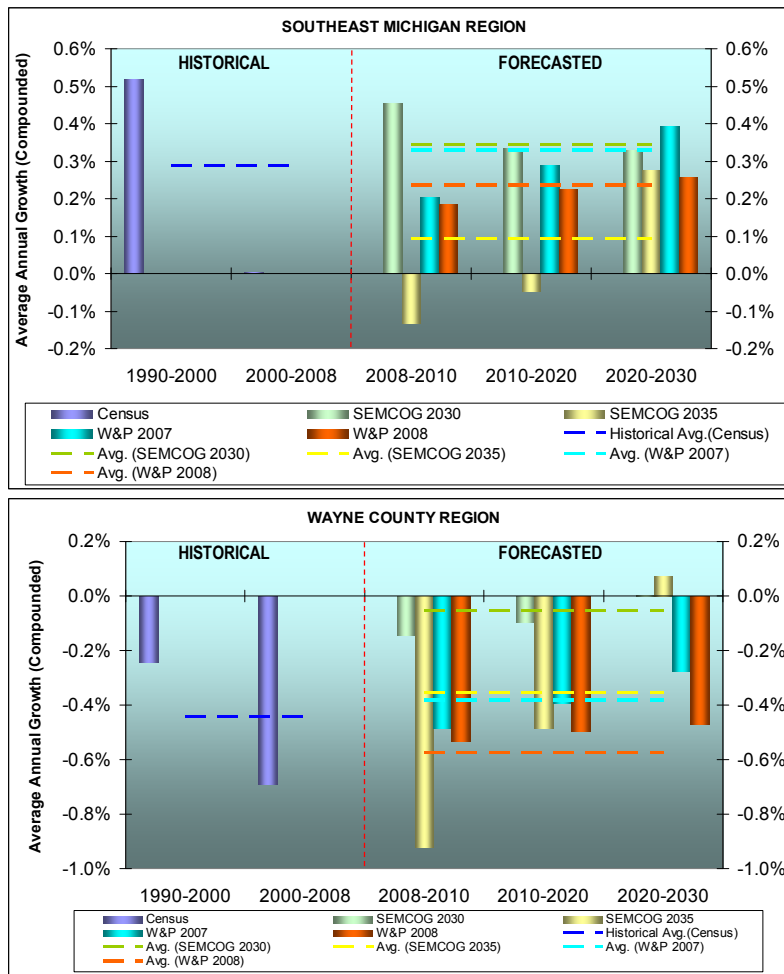

Figure 4-10. Southeast Michigan County Boundaries

POPULATION TRENDS AND PROJECTIONS

The regional growth around the SEMCOG area is, to an extent, dependent on the population growth within Michigan and the local towns/cities within the study area. The congestion characteristics that may affect crossing route choice are predominately dependent on the localized regional growth. An evaluation of the historical and projected local population trends within the SEMCOG region is provided in **Figure 4-11**, and demonstrates that the population in SEMCOG has historically grown at an average annual rate of 0.3 percent between 1990 and 2008, according to Census and, according to the latest SEMCOG 2035 RTP projections, is forecasted to grow at an average annual rate of 0.1 percent between 2006 and 2030 (the previous projections showed an average annual growth of 0.3 percent annually which is consistent with several historical Woods and Poole forecasts). The recent economic turmoil, in conjunction with the restructuring that the automotive industry is undergoing, has resulted in a downward projection of

future growth trends within the Detroit area. The Woods and Poole 2008 CEDDS projects the region's population to grow at an average annual rate of 0.2 percent between 2008 and 2030, but does not take into account the recent 2009 trends. The total population in 2008, according to the latest Census estimates, was approximately 4.8 million within the SEMCOG region, and is now forecasted to range between 4.5 and 5.0 million by 2030 (the 2030 RTP SEMCOG forecasts showed the total population at over 5.3 million and the Woods and Poole 2008 CEDDS forecasted close to 5.1 million). The SEMCOG 2035 RTP population official demographic growth for the region was deemed reasonable for use as part of this comprehensive study based on comparisons with several independent forecast sources. The local growth within the SEMCOG region contributes to the border crossing demand, however, the overall influence of this growth on the total crossing demand is somewhat dampened by the many other border crossing markets that are not locally-based.



Sources: Census, SEMCOG and Woods and Poole CEDDS 2007, 2008
 Note: Southeast Michigan exhibit not historical average annual growth between 2000 and 2008

Figure 4-11. Historical and Projected Regional Population Trends

Figure 4-12 also illustrates a disaggregated review of the local population growth trends in Wayne County, which encompasses the city of Detroit. The growth within Wayne County has been decreasing at an average annual rate of -0.4 percent over the last 18 years, between 1990 and 2008, based on data from Census and is projected to continue to decline at an average annual growth rate of close to -0.4 percent between 2008 and 2030. There is general consensus across all forecast sources that this county will continue to experience declines in population between 2008 and 2030. The total Wayne County population in 2008 was 1.9 million and is projected to be contract to between 1.7 to 1.83 million by 2030. More recent Woods and Poole 2008 CEDDS projects the county population to shrink by -0.6 percent annually between 2008 and 2030, and forecasts a population of 1.8 million by 2030.

The historical municipal population trends within SEMCOG, as illustrated in **Figure 4-12**, shows that the combined net population gain for the entire SEMCOG region was over 301,000 between 1986 and 2008. Oakland County captured the greatest net population gain of over 168,000 and exhibited an average annual compounded growth rate of 0.7 percent between 1986 and 2008, while Wayne County lost over 209,000 during that same period.

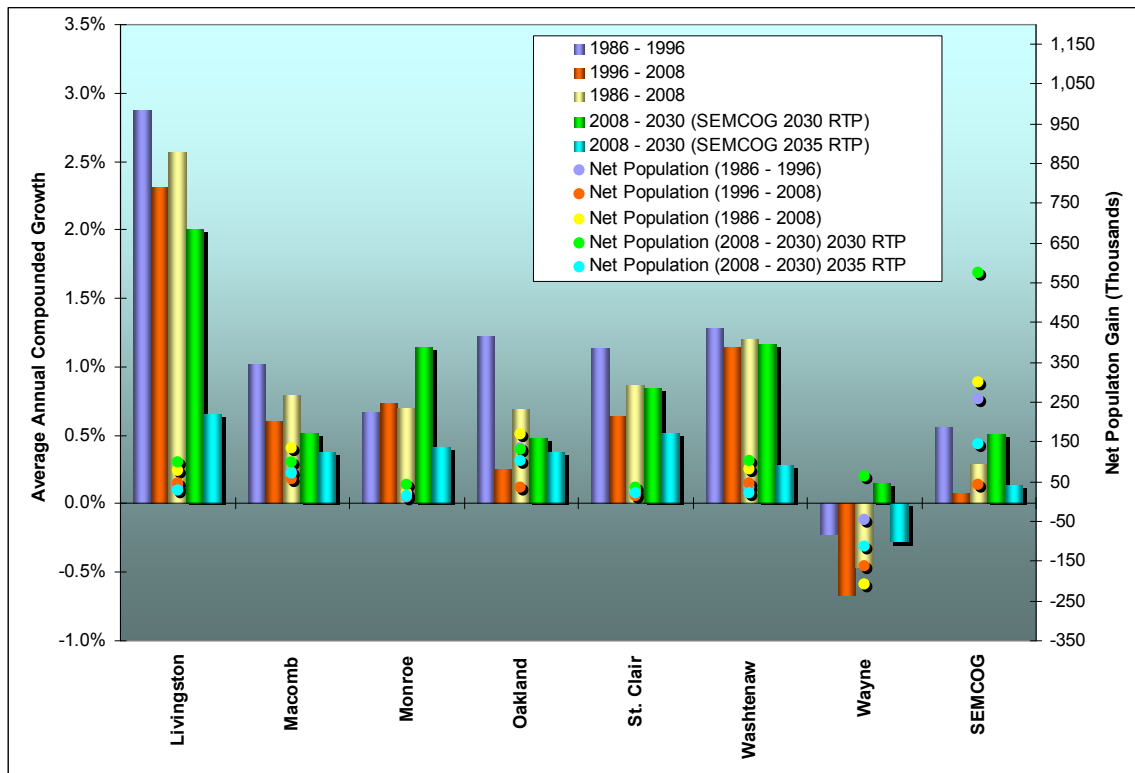

Sources: Census, SEMCOG 2030 & 2035 RTP

Figure 4-12. Historical County Population Trends

Livingston County, on the other hand, showed the highest average annual growth rate of 2.6 percent between 1986 and 2008. The projected population gains for the entire SEMCOG region are also highlighted for both the previous 2030 SEMCOG plan and the revised 2035 SEMCOG plan show the recent modifications in forecasts for the counties within the SEMCOG boundaries. The projections for Livingston County underwent the largest changes while the projections for St. Clair County had the least changes between the two forecasts. The overall difference by 2030, between the 2030 RTP and 2035 RTP projections shows a reduction in population of over 431,000.

The overall 2008 distributional population shares of the various counties within the SEMCOG region, as illustrated in **Figure 4-13**, show that Wayne County currently accounts for over 40 percent of the overall SEMCOG regional population. Oakland and Macomb Counties, located to the north of Detroit, account for approximately 25 and 17 percent of the overall SEMCOG regional population, respectively.

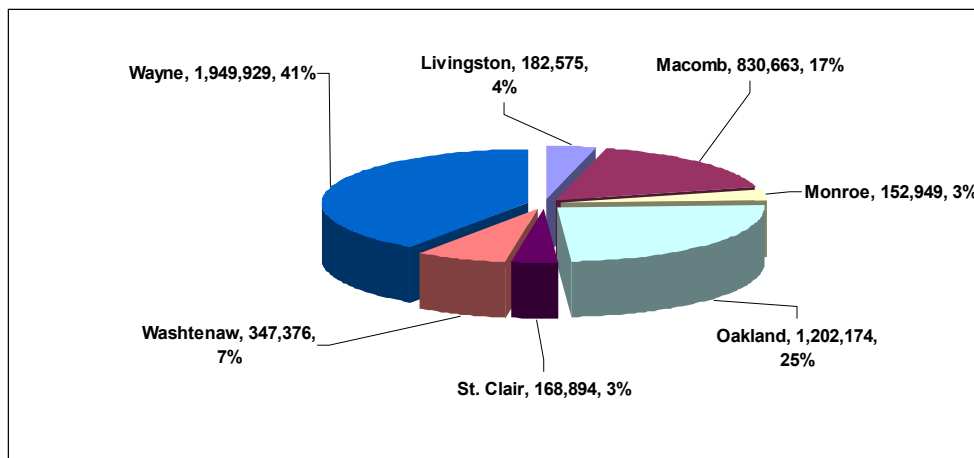

Sources: Census 2008

Figure 4-13. 2007 SEMCOG County Population Share

EMPLOYMENT TRENDS AND PROJECTIONS

The regional growth around the SEMCOG region is, to an extent, also dependent on the employment growth within Michigan and the local towns/cities within the study area. An evaluation of the historical and projected employment trends within the SEMCOG region are provided in **Figure 4-14** and demonstrate that the employment in SEMCOG counties has historically grown at an average annual rate of 0.7 percent between 1996 and 2008, according to Census, and is projected to grow at an average annual rate of 0.3 percent between 2008 and 2030, according to the latest 2035 RTP SEMCOG forecasts (more recent Woods and Poole 2008 CEDDS forecasts show an average annual rate of 0.9 percent compared to 1.1 percent in the 2007 forecasts respectively). The 2035 RTP

projections show a 0.3 percent average annual growth in employment over the next 22 years.

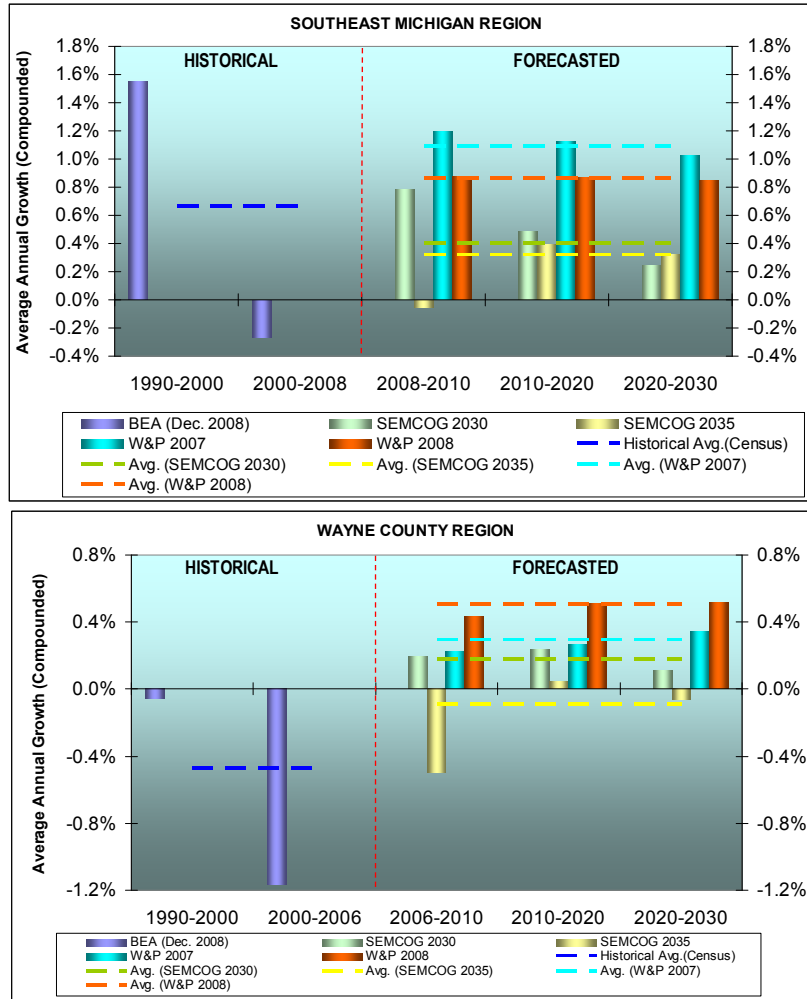

Sources: Census, SEMCOG and Woods and Poole CEDDS 2007, 2008

Figure 4-14. Historical and Projected Regional Employment Trends

The overall employment forecasts show that the projected trends are expected to be significantly lower between 2008 and 2010, compared to the historical trends over the last 15 years. **Figure 4-14** also illustrates a disaggregated review of the local employment growth trends in Wayne County, within which the city of Detroit is located, and its surrounding counties. Historically, the employment in Wayne County has been shrinking at an average annual rate of 0.5 percent between 1990 and 2006, based on Census, and is expected to continue to shrink at an average annual growth rate of close to -0.1 percent annually between 2006 and 2030, according to the latest SEMCOG 2035 RTP forecasts, with the largest decline occurring between 2008 and 2010. The recent Woods and Poole 2008 CEDDS, on the other hand, has revised its employment projections upwards and

predicts that employment will grow at an average annual growth rate of close to 0.5 percent between 2006 and 2030, from the previous projection of 0.2 to 0.3 percent. Currently, there is uncertainty as to the level of diversification and employment growth that will occur with the Detroit region in the short-term as a result of the restructuring of the automobile industry. This has resulted in varying forecasts pertaining to the employment growth in the region. The current 2035 RTP reflects a reasonable middle ground for all long-term forecasts and reflects a significantly dampened employment growth for the SEMCOG region compared to the historical long-term trends observed between 1996 and 2008.

The employment historical trends for the counties within the SEMCOG region, as illustrated in **Figure 4-15**, show that Oakland County captured the greatest net employment gain of close to 190,000 between 1991 and 2007 while Wayne County lost over 27,000 during that same period. Livingston County showed the highest average annual growth of 3.8 percent between 1991 and 2007. The combined net employment gain for the entire SEMCOG region was over 318,000 between 1991 and 2007. The projected employment gains for the entire SEMCOG region are also highlighted for both the previous 2030 SEMCOG plan and the revised 2035 SEMCOG plan to show the variation in forecasts for the counties within the SEMCOG boundaries.

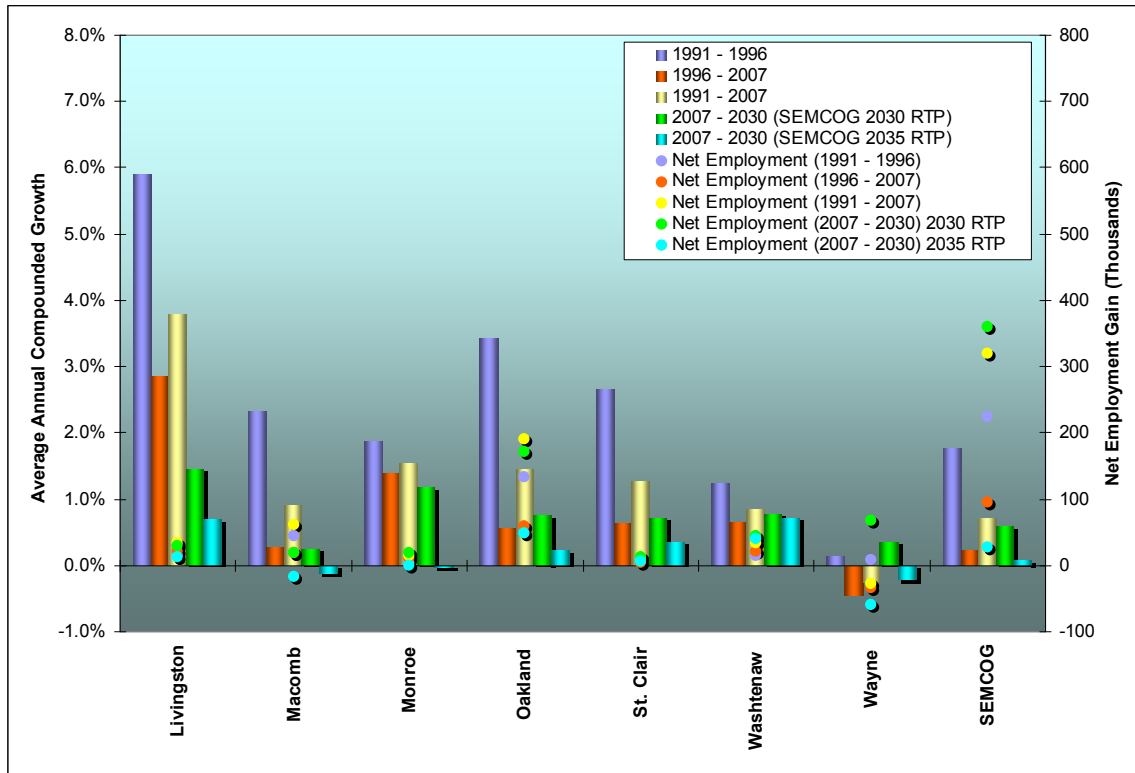

Sources: Census, SEMCOG 2030 & 2035 RTP

Figure 4-15. Historical SEMCOG County Employment Trends

The overall 2007 distributional employment share of the various counties within the SEMCOG region, as illustrated in **Figure 4-16**, shows that both Wayne and Oakland counties currently each account for over 34 percent of the overall SEMCOG regional employment while Macomb County, located to the north of Detroit, accounts for approximately 15 percent of the overall SEMCOG regional employment.

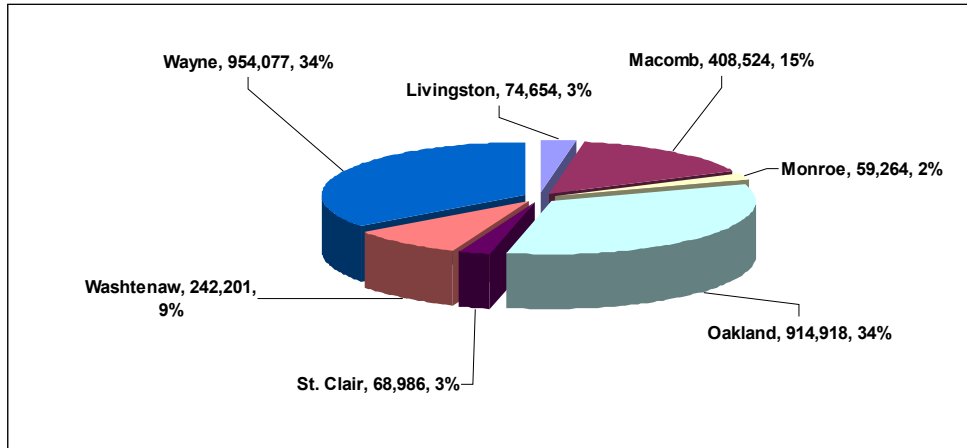

Sources: Bureau of Economic Analysis 2007

Figure 4-16. 2007 SEMCOG County Employment Share

UNEMPLOYMENT TRENDS

The unemployment rate trends within the various counties are provided in **Figure 4-17**, along with the more recent quarterly unemployment within the Detroit and SEMCOG region. As shown, the city of Detroit and SEMCOG region have historically had varied unemployment rates of 3.7 percent in 2000 that increased to over 8.5 by 2008, which was slightly higher than the Michigan average. Washtenaw County had the lowest unemployment rates of all the counties within the SEMCOG region, while St. Clair County exhibited the highest unemployment rates. More recently, the quarterly unemployment rates indicate that the 2008 and 2009 unemployment rates have been trending significantly higher than the 2006 levels for all the SEMCOG region counties. The quarterly data indicates a slight decline in the unemployment rate which is somewhat indicative of the possible reversal in the job loss trend within the region towards the fourth quarter of 2009.

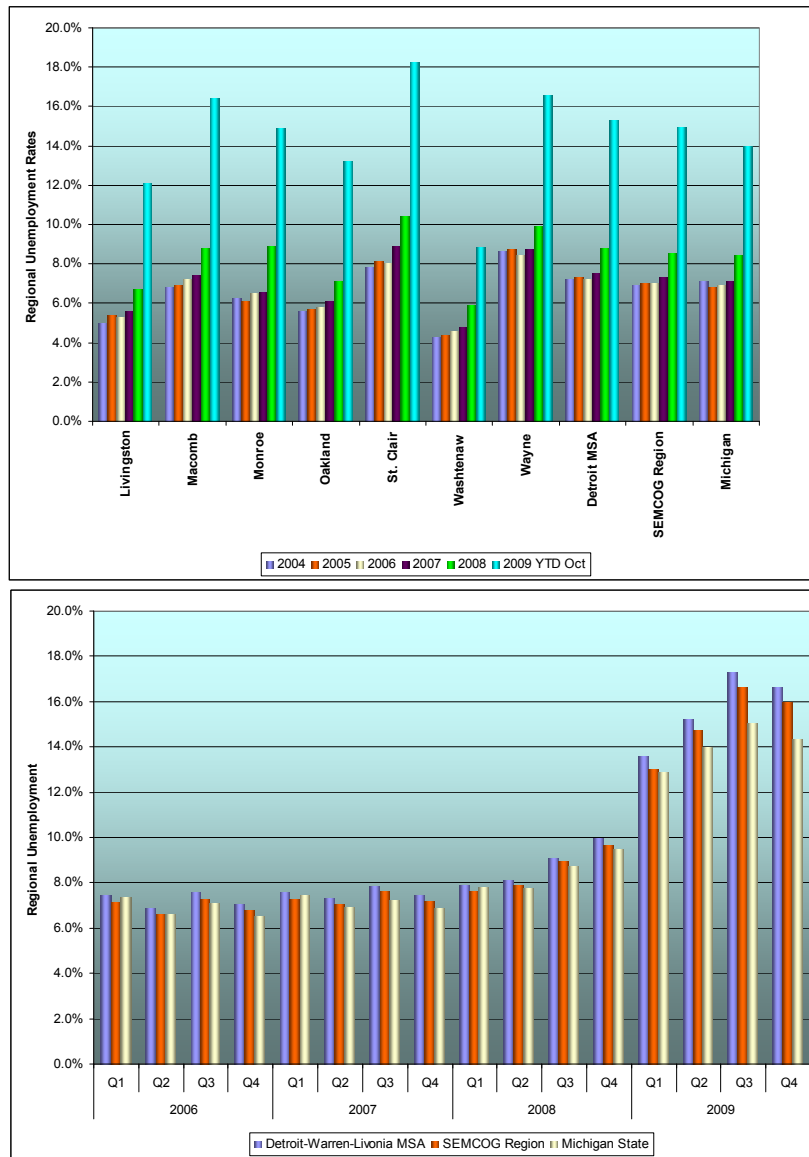

Sources: Bureau of Labor Statistics (2009 reflects year-to-date October results)

Figure 4-17. County and Regional Unemployment Trends

HISTORICAL PERSONAL INCOME/EARNING TRENDS

The personal income growth within Wayne County, the SEMCOG region, and Michigan is an important socio-economic variable that provides an indication of the real income trends that are directly correlated with the regional markets' ability and willingness to pay tolls. An evaluation of the historical real personal income and income per capita trends for the three geographic regions is provided in **Figure 4-18**. Personal income is a measure commonly used by the U.S. government and private institutions to measure the

income of a household. The measure includes the annual pre-tax money receipts (wages and salaries, unemployment insurance, disability, child support, etc.) of all residents over 15 years old. The real personal income in Michigan historically grew at an average annual rate of 1.5 percent in real terms, while the average income per capita grew at a similar rate of 1.6 percent annually between 1996 and 2006, according to Woods and Poole 2008 CEDDS. Michigan personal income is projected to increase at an average annual rate of 1.8 percent, while the income per capita is expected to grow at approximately 1.1 percent between 2006 and 2030. The real personal income in the SEMCOG region follows a similar trend to that of Michigan, however, the income per capita growth has historically been lower at 0.8 percent annually between 1996 and 2006 and is projected to grow at a higher rate than the State between 2006 and 2030.

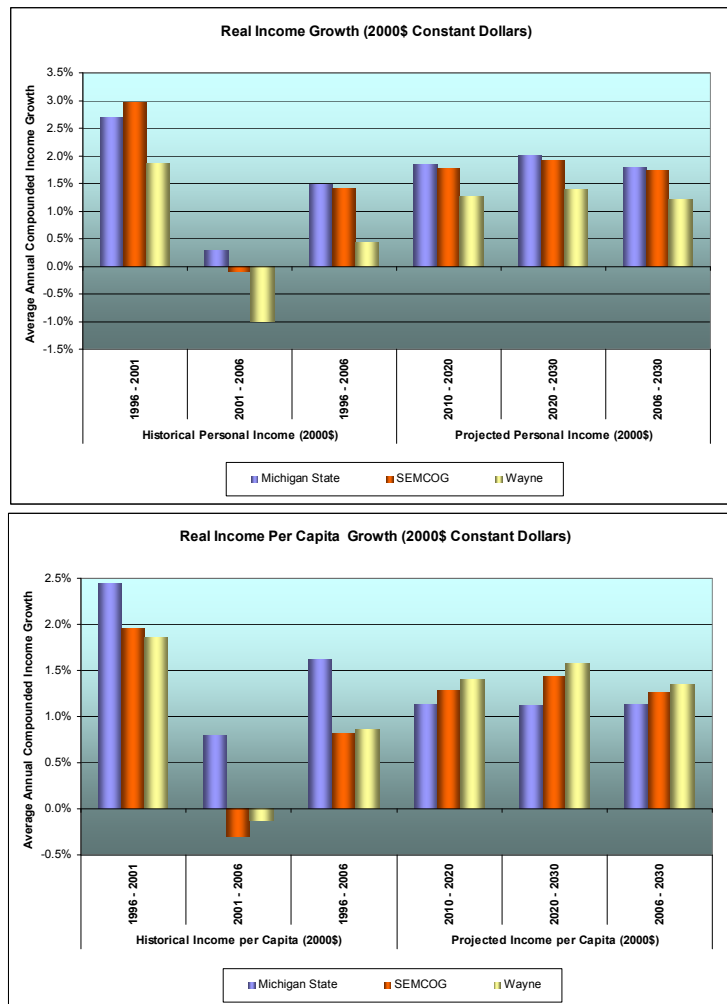

Sources: Woods and Poole 2008 CEDDS

Figure 4-18. Historical Regional Personal Income Trends

The Wayne County personal income has historically grown at a rate of 0.4 percent annually between 1996 and 2006, and is projected to grow by 1.2 percent annually between 2006 and 2030, with the personal income per capita growing at a faster rate than the state or regional averages. This is in part a result of the declining population forecasted within the county.

The overall 2008 distributional personal income of the various counties within the SEMCOG region, as illustrated in **Figure 4-19**, shows that St. Clair County currently has the highest personal income levels and is projected to continue to have the highest average by 2030. Oakland and Washtenaw Counties are currently below the state average and are expected to continue to remain below the state average by 2030. The remaining counties within the SEMCOG region are shown to currently be very close to the state average levels and are expected remain at these levels by 2030, while Wayne County is currently slightly above the state average and is projected to remain higher than the state average by 2030.

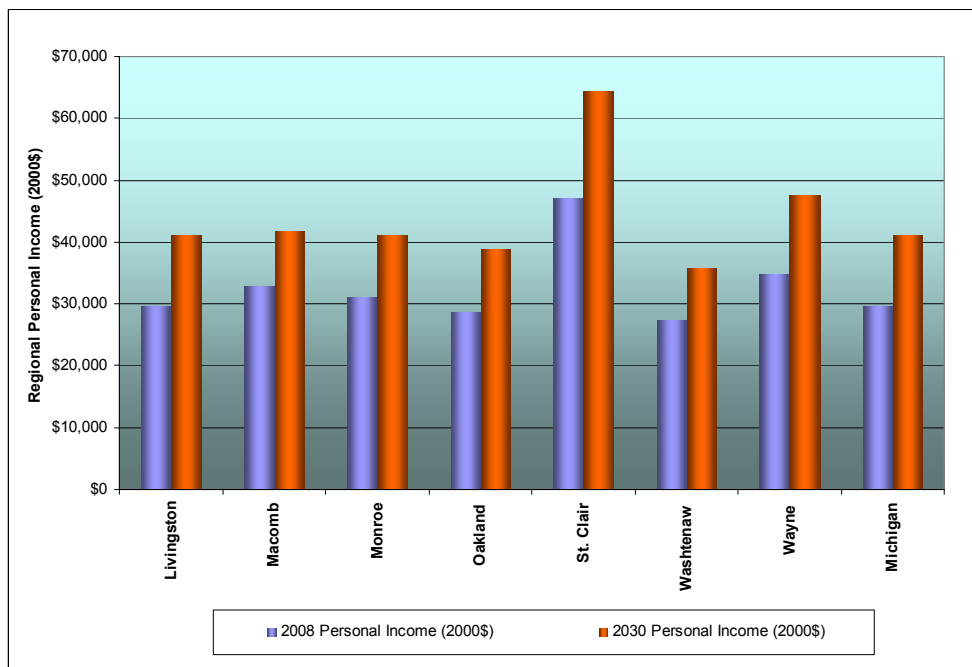

Sources: Woods and Poole 2008 CEDDS

Figure 4-19. SEMCOG County Personal Income Trends

HISTORICAL CONSUMER PRICE INDEX TRENDS

The rate of inflation within the economy reflects the gain or erosion of purchasing power within a region and provides an estimate for the likely potential and magnitude with which toll rates may be increased within the region to keep up with the inflationary trends. The growth in the consumer price index (CPI) provides such

an indication and the local and national historical CPI growth trends are illustrated in **Figure 4-20**. The CPI growth has shown that some significant fluctuations occurred between 1985 and 1990, however, since this time, the CPI growth in Detroit has averaged approximately 2.6 percent, while the U.S. national CPI has averaged close to 2.8 percent annually between 1990 and 2008. More recently, the CPI has declined drastically and will for the first time since 1949 indicate a negative CPI trend for 2009.

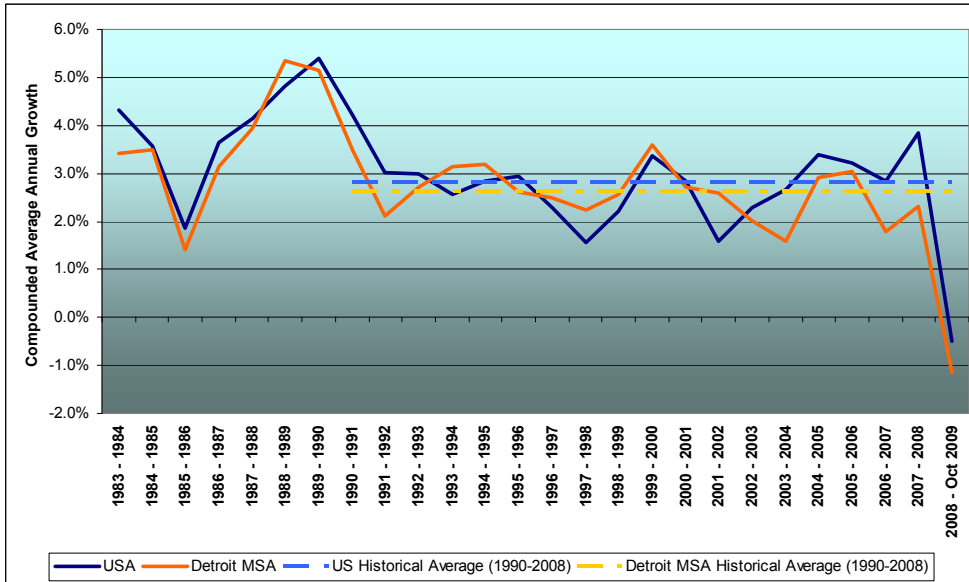

Sources: Bureau of Labor Statistics

Figure 4-20. Historical Consumer Price Index Growth Trends

THE WINDSOR/SARNIA REGIONAL ECONOMY

The following section provides a more detailed review of the historical and projected trends of the local Canadian economies and socio-economic characteristics within the study area and around the existing crossings in the Windsor and Sarnia regions. The city of Windsor in Essex County (known as Windsor-Essex) is located in south western Ontario and borders Kent/Chatham County and Lambton County to the north east of Windsor-Essex. Between 1996 and 2001, the Windsor-Essex region experienced relatively strong growth that exceeded the overall Province of Ontario regional growth, with the majority of this growth consisting of international migration into the region. The main regions within Essex County include:

- The city of Windsor;
- The town of Tecumseh (formally known as the South Sandwich area);
- The town of LaSalle (a fast growing municipality in the Windsor region);

- The town of Lakeshore (a fast growing municipality in the Windsor region);
- The town of Amherstburg;
- The town of Essex;
- The town of Kingsville; and
- The municipality of Leamington.

Figure 4-21 illustrates the municipal boundaries of the various cities and towns within Essex County.

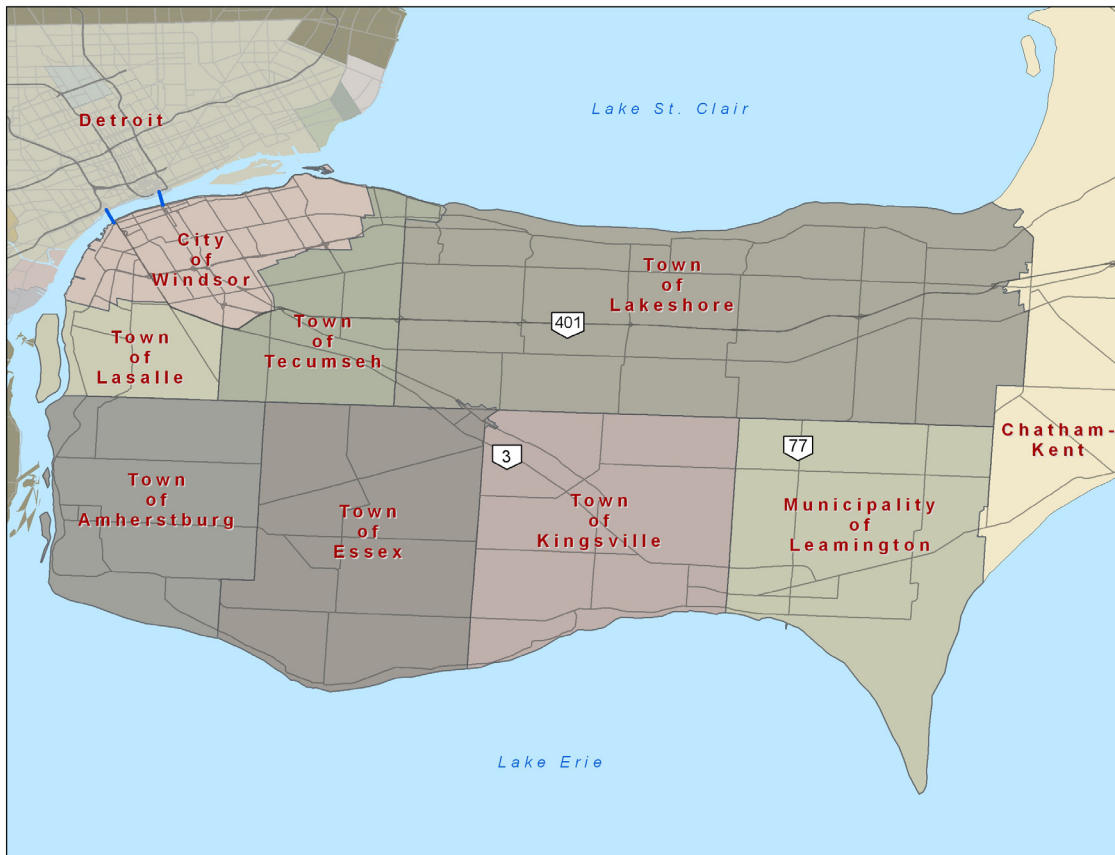

Figure 4-21. Essex County Municipal Boundaries

The annual population forecasts for three relevant census divisions within Ontario (Essex, Lambton, and Chatham-Kent) were available from the Ontario Ministry of Finance⁶, while employment forecasts between 2001 and 2051 were obtained from the Centre for Spatial Economics (C4SE). The disaggregate employment and population forecasts for

⁶ Ontario Population Projections Update, 2006 -2031: Ontario and Its 49 Census Divisions, based on the 2001 Census; Ontario Ministry of Finance, Spring 2007

the municipalities within the Essex Census Division were developed by IBI Group, for the year 2021⁷ and additional forecasts as summarized in previous sections included:

- Lapointe Consulting, Inc.⁸: population projections for the city of Windsor;
- EDP Consulting⁹: employment forecasts for the city of Windsor in five year increments through 2026.

POPULATION TRENDS AND PROJECTIONS

The regional growth around the Windsor-Essex area is, to an extent, dependent on the population growth within the province and the local towns/cities within the study area. The congestion characteristics that may affect crossing route choice is predominately dependent on the localized regional growth, whereas the magnitude of the local border crossing demand itself is dependent on the growth occurring in both Windsor and Detroit and the symbiotic nature of the growth. An evaluation of the historical and projected local population trends within the Windsor-Essex region are provided in **Figure 4-22** and demonstrate that the population in Windsor-Essex has historically grown at an average annual rate of 1.4 percent between 1990 and 2009, according to Statistics Canada, and is projected to grow at an average annual rate of 0.9 percent between 2008 and 2030, based on the Centre for Spatial Economics (the Lapointe projections show a consistent 1.0 percent average annual growth during the same period and does not account for the more recent 2008 and 2009 trends). The total population in 2008 was over 422,000 within the Windsor-Essex region according to Statistics Canada and is forecasted to be over 487,000 by 2030 according to official projections.

⁷ Essex-Windsor Regional Transportation Master Plan. IBI Group. October 2005.

⁸ Windsor-Essex and City of Windsor Population and Housing Projections: 2006-2031 and Affordable Housing Targets. Prepared by Lapointe Consulting, Inc. for the city of Windsor Planning Department. January 16, 2008.

⁹ City of Windsor Employment Projections & Employment Lands Needs Analysis. Prepared for the City of Windsor Planning Department by EDP Consulting. January 15, 2008.

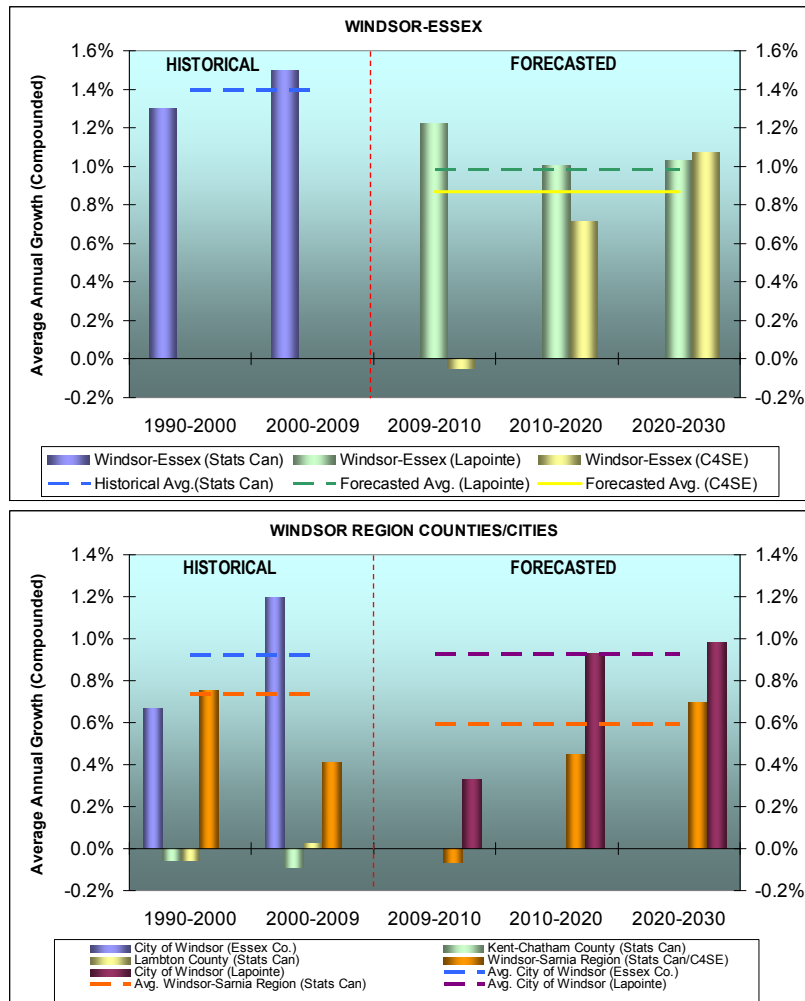

Sources: Statistics Canada (Stats Can), Lapointe Consulting (Lapointe), Essex County (Essex Co.), Centre for Spatial Economics (C4SE)

Figure 4-22. Historical and Projected Regional Population Trends

The overall population forecasts show that the projected trends are lower than the historical trends over the last 15 years and, to an extent, account for the current economic climate, lower levels of net migration to the region, and the challenges the regional economic engines will face as a result of foreign competition. **Figure 4-22** also illustrates a disaggregated review of the local population growth trends in the city of Windsor and its surrounding counties. The city of Windsor has historically grown at an average annual rate of just over 0.9 percent between 1996 and 2009, based on data collected from Essex County, and is expected to grow according to the 2008 city of Windsor Official Plan Review (produced by Lapointe Consulting) at an average annual growth rate of close to 0.9 percent annually between 2009 and 2030. Kent-Chatham and Lambton Counties have both experienced flat or negative growth over the last 15 years; however, the overall Windsor-Sarnia region has historically grown at an average annual rate of just over 0.6

percent between 1996 and 2009, based on data collected from Statistics Canada, and, according to the Centre of Spatial Economics, is expected to grow at an average annual growth rate of close to 0.6 percent between 2009 and 2030. The total population in 2009 was over 650,000 within the Windsor/Sarnia region, and is projected by the Centre of Spatial Economics to exceed 731,000 by 2030.

The municipal population historical trends within Essex County, as illustrated in **Figure 4-23**, shows that the city of Windsor captured the greatest net population gain of over 31,000 and exhibited an average annual compounded growth of 0.6 percent between 1996 and 2009. The towns of La Salle, and Lakeshore, on the other hand, showed the highest average annual growth of 3.1 percent between 1996 and 2009. The combined net gain of these two towns amounted to a population gain of close to 23,000 and accounted for 32 percent of the overall population gains between 1996 and 2009. The projections detailed within the Windsor-Essex Development Commission community profiles, as forecasted by the Financial Post, shows expected short term growth until 2014. The towns of Tecumseh and Essex are expected to experience declining population trends between 2009 and 2014, while the towns of Lakeshore and LaSalle are expected to generate the most growth over this same period.

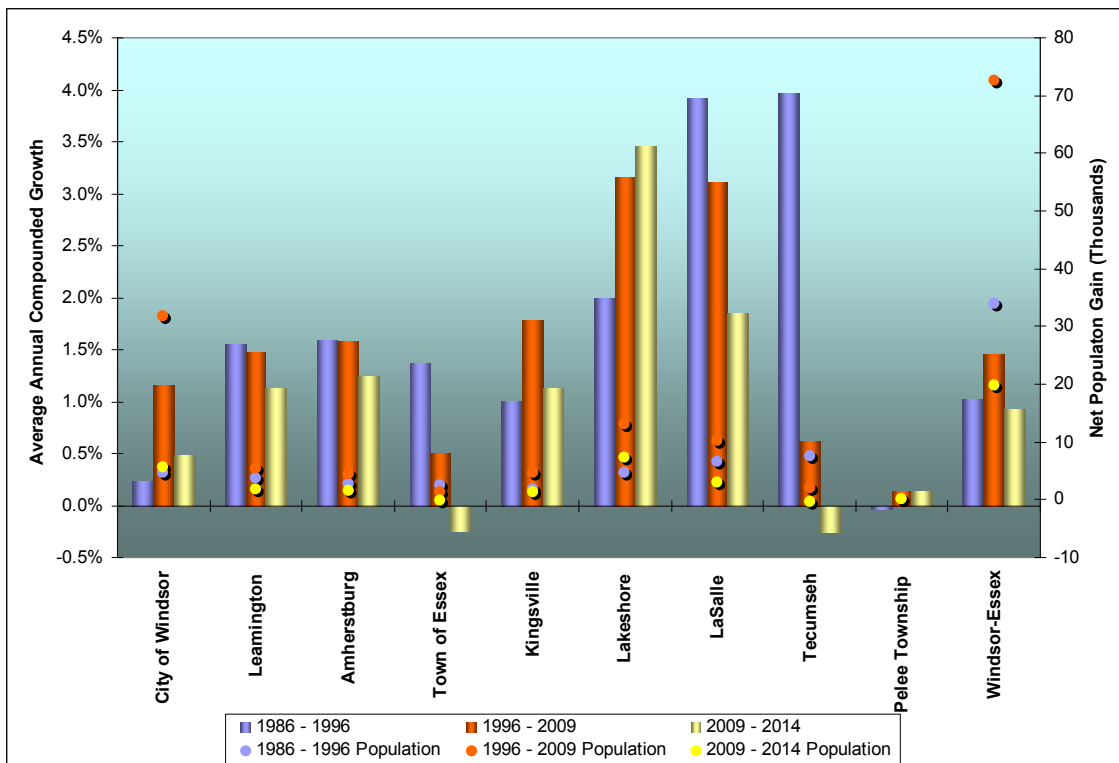

Sources: Statistics Canada, Windsor-Essex Development Commission 2009 Community Profiles – Financial Post Forecasts

Figure 4-23. Historical Municipal Population Trends

The overall 2006 distributional population shares of the various municipalities within Essex Counties, as illustrated in **Figure 4-24**, shows that the city of Windsor currently accounts for over 56 percent of the overall county population. The municipalities of La Salle and Tecumseh are located within the closest proximity to the new proposed border crossing corridor, and account for approximately 6 and 7 percent of the overall Essex County population, respectively.

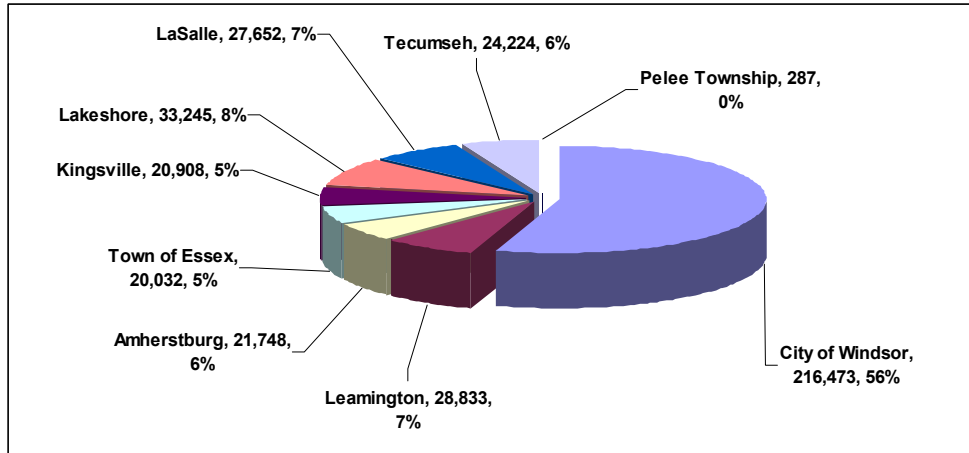

Sources: Windsor-Essex Development Commission 2009 Community Profiles

Figure 4-24. 2009 Essex County Municipal Population Share

EMPLOYMENT TRENDS AND PROJECTIONS

The regional growth around the Windsor-Essex area is, to an extent, also dependent on the employment growth within the province and the local towns/cities within the study area. An evaluation of the historical and projected employment trends within the Windsor Census Metropolitan Area (CMA) (comprised of the city of Windsor, and the towns of La Salle, Tecumseh, Lakeshore, and Amherstburg) are provided in **Figure 4-25**, and demonstrate that the employment in Windsor CMA has historically grown at an average annual rate of 1.3 percent between 1996 and 2006, according to Statistics Canada, and, according to the city of Windsor Official Plan Review Study (conducted by EDP Consulting, January 2008), is projected to grow at an average annual rate of 0.8 percent between 2006 and 2030.

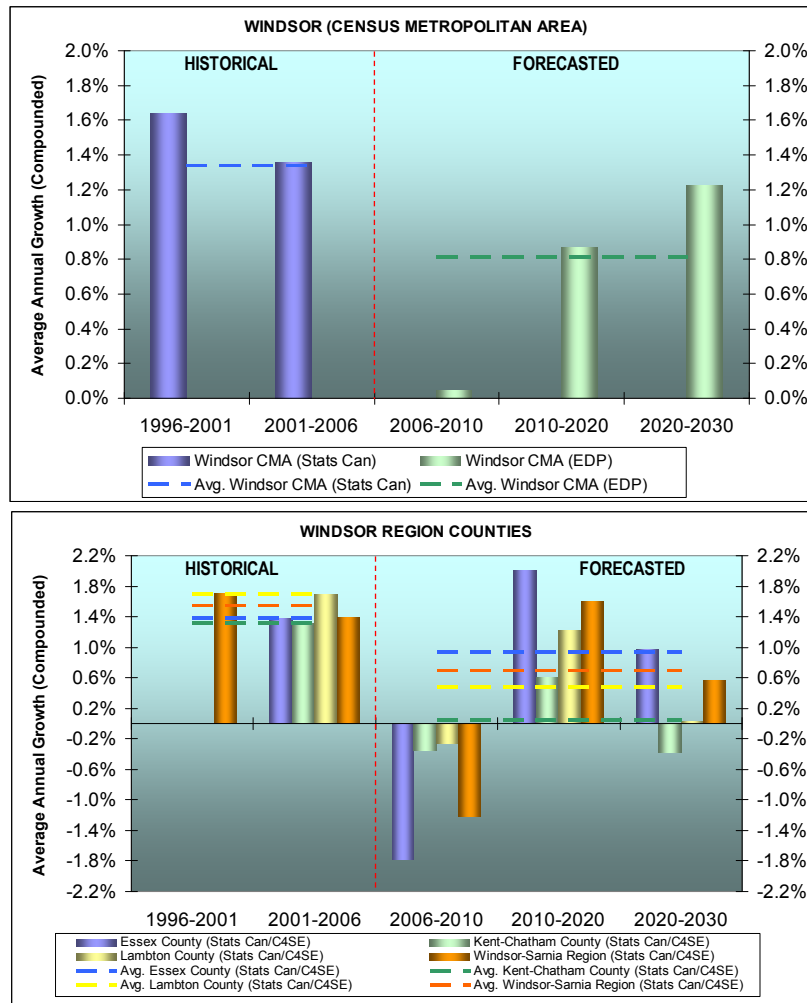

Sources: Statistics Canada (Stats Can), EDP Consulting (EDP), Essex County (Essex Co.), Centre for Spatial Economics (C4SE)

Figure 4-25. Historical and Projected Regional Employment Trends

The overall employment forecasts show that the projected trends are expected to be very low between 2006 and 2010, compared to the historical trends over the last 15 years, and expect to increase thereafter as the Windsor economy transforms from a heavy manufacturing economy to a light manufacturing and a service-oriented economy. **Figure 4-25** also illustrates a disaggregated view of the local employment growth trends in Essex County (within which the city of Windsor is located) and its surrounding counties. Historically, the employment in Essex County has grown at an average annual rate of 1.4 percent between 2001 and 2006, based on data collected from Statistics Canada, and, according to Centre for Spatial Economics, is expected to grow at an average annual growth rate of close to 0.9 percent between 2006 and 2030. Kent-Chatham and Lambton Counties have both experienced employment growth of 1.3 and 1.7 percent between 2001 and 2006, respectively, and are forecasted to grow at an average annual rate of 0.0 and

0.5 percent between 2006 and 2030, respectively. The overall Windsor-Sarnia region has historically grown at an average annual rate of just over 1.5 percent between 1996 and 2006, based on data collected from Statistics Canada, and, according to the Centre of Spatial Economics, is expected to grow at an average annual growth rate of close to 0.7 percent annually between 2006 and 2030.

A detailed look at the recent historical trend of the labor force and employment levels within the Windsor CMA and Windsor-Sarnia region, as illustrated in **Figure 4-26**, shows that the largest decline in employment and labor force activity within the Windsor CMA and Windsor-Sarnia region occurred within the first quarter of 2007.

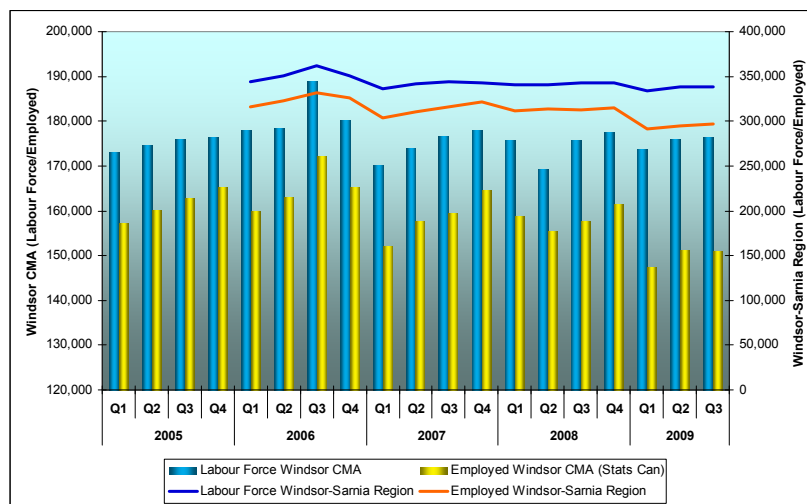

Sources: Statistics Canada, Labor Force Survey

Figure 4-26. Quarterly Short-term Labor Force/Employment Trends

This was as a result of several permanent layoffs by the Windsor-based domestic automakers, which included Chrysler, General Motors and the Ford Motor Company and several other companies dealing with the current recessionary trends.

The total labor force in 2008 averaged close to 175,000 within the Windsor CMA region and approximately 341,000 within the entire Windsor-Sarnia region. The employment in 2008 was approximately 158,000 employed persons within the Windsor CMA and 313,000 within the Windsor-Sarnia region. The trend in the first three quarters of 2009 shows that while the employment decreased in the first quarter of 2009, it has since been increasing steadily in every subsequent quarter. This rate of increase is much slower than what had previously been experienced between 2006 and 2007. The overall employment within the Windsor-Sarnia region of 341,000 in 2008 is forecasted to grow an average annual growth rate of 0.7 percent between 2008 and 2030.

The labor force and employment historical trends for the municipalities within Essex County, as illustrated in **Figure 4-27**, show that the city of Windsor captured the greatest net labor force activity gain of close to 17,000 and had a net employment gain of over 8,400 between 1996 and 2006. The towns of La Salle, Lakeshore and Tecumseh showed the highest average annual growth trends between 1996 and 2006 with the town of La Salle exhibiting the strongest average annual compounded growth of 3.2 percent in labor force growth and 3.0 percent average annual growth for employment during this period. The combined net gain of these three towns amounted to an employment gain of close to 8,700 (37 percent of the overall Windsor-Essex regional employment gains) and a labor force gain of 13,840 (34 percent of the regional gain) between 1996 and 2006.

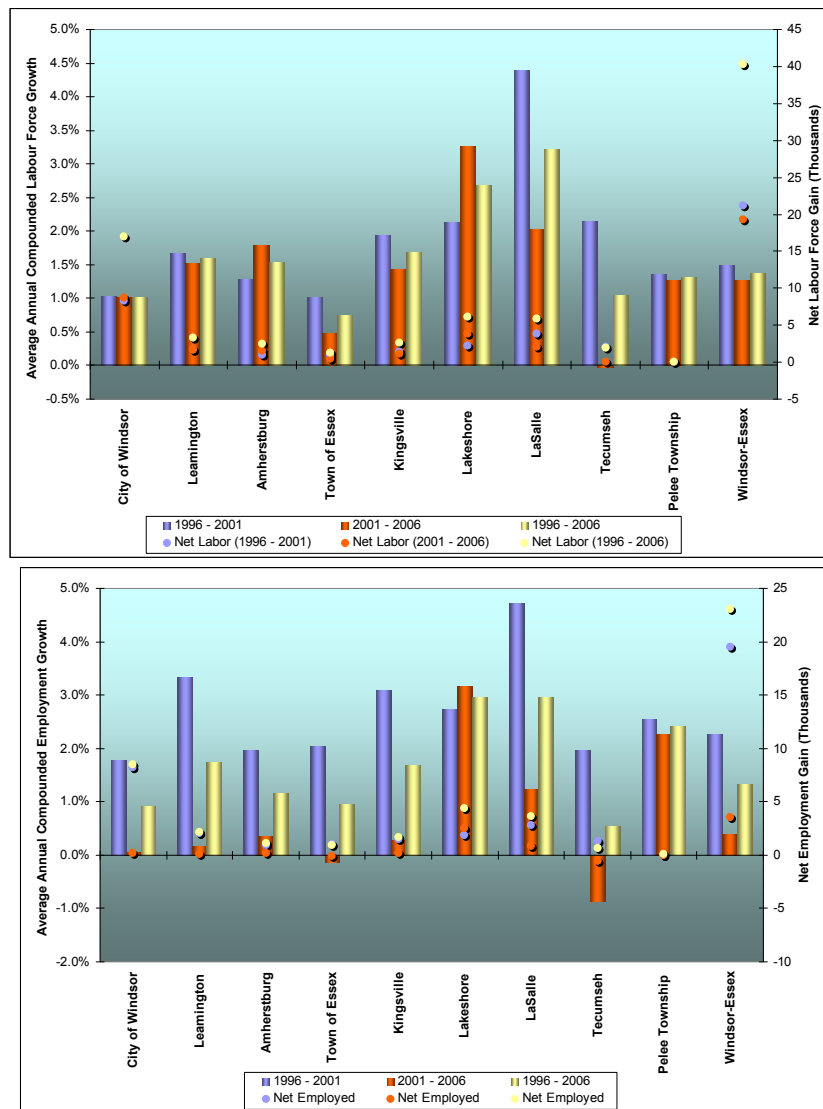

Sources: Statistics Canada

Figure 4-27. Historical Municipal Labor Force and Employment Trends

The overall 2006 distributional labor force/employment share of the various municipalities within Essex Counties, as illustrated in **Figure 4-28**, shows that the city of Windsor currently accounts for over 57 percent of the overall county labor force and 52 percent of the employed. The municipalities of La Salle and Tecumseh are located within the closest proximity to the new proposed border crossing corridor, and account for approximately 6 and 7 percent of the overall Essex County labor force and 7 and 8 percent of the employed markets, respectively.

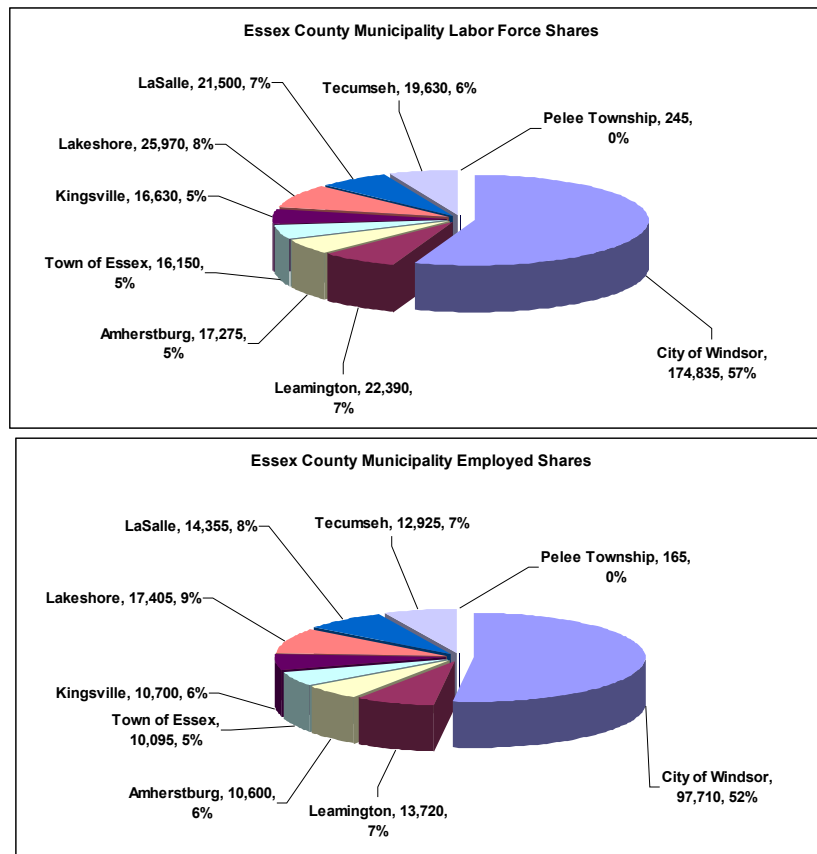

Sources: Statistics Canada

Figure 4-28. 2006 Essex County Municipal Labor Force and Employment Share

UNEMPLOYMENT TRENDS

The unemployment rate trends within the various municipalities is provided in **Figure 4-29**, along with the more recent quarterly unemployment trends within the Windsor CMA and Windsor-Sarnia region. As shown, the city of Windsor has historically had unemployment rates ranging between 7.5 and 9.7 percent prior to 2008, which is higher

than the Province of Ontario average, while LaSalle generally had the lowest unemployment rates of all the regions within Essex County.

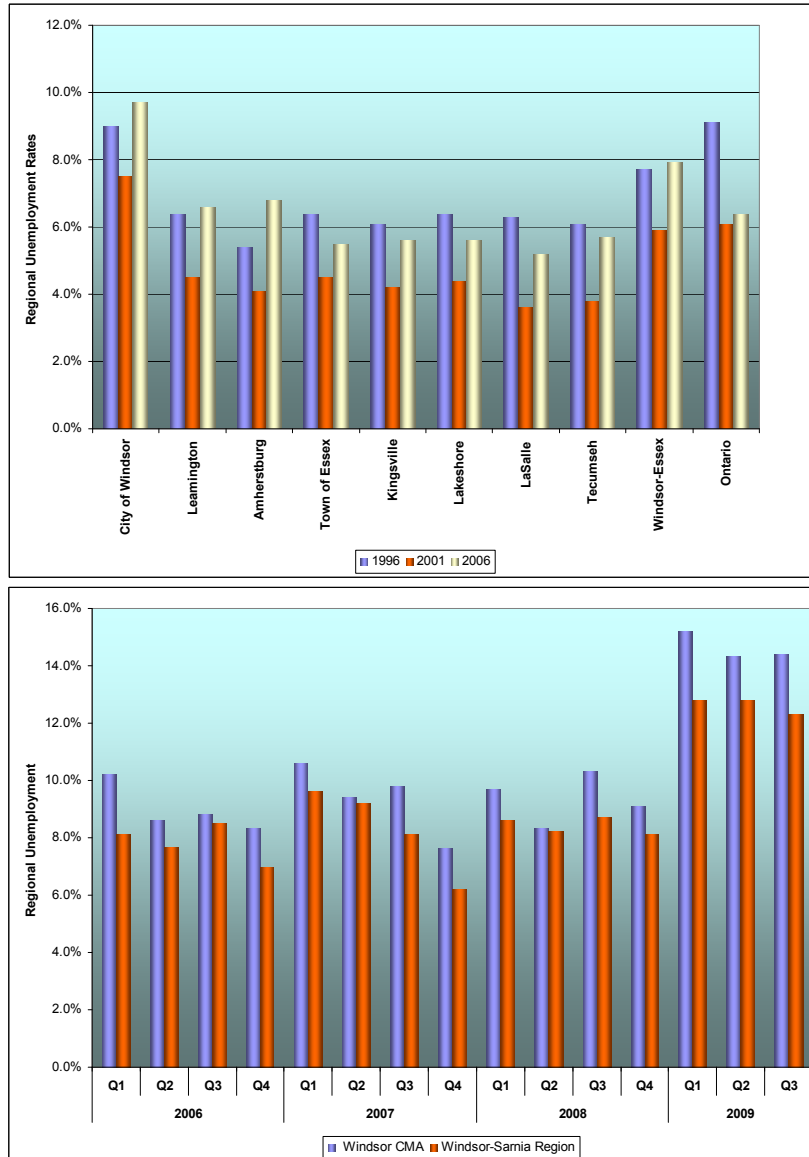

Sources: Statistics Canada

Figure 4-29. Municipal and Regional Unemployment Trends

More recently in 2009, the quarterly unemployment rates for both the Windsor CMA and Windsor-Sarnia region have been trending significantly higher than the 2006 levels with the Windsor CMA averaging over 12 percent. The third quarter in both regions has shown signs of a declining unemployment rate, however, this rate still remains high.

HISTORICAL HOUSEHOLD INCOME/EARNING TRENDS

The regional income growth around the Windsor-Essex area is an important socio-economic variable that provides an indication of the real income trends that are directly correlated with the regional traveling markets' ability and willingness-to-pay tolls. An evaluation of the historical nominal and inflation adjusted household average and median income trends within the Windsor-Essex region, compared to the provincial and national trends is provided in **Figure 4-30**. The Windsor-Essex region's average household income historically grew at an average annual rate of 1.0 percent in real terms and 3.0 percent in nominal terms between 1996 and 2006, according to Statistics Canada. The average household income growth has been slower than the provincial and national growth rates of 1.6 percent in real terms and 3.7 percent in nominal terms.

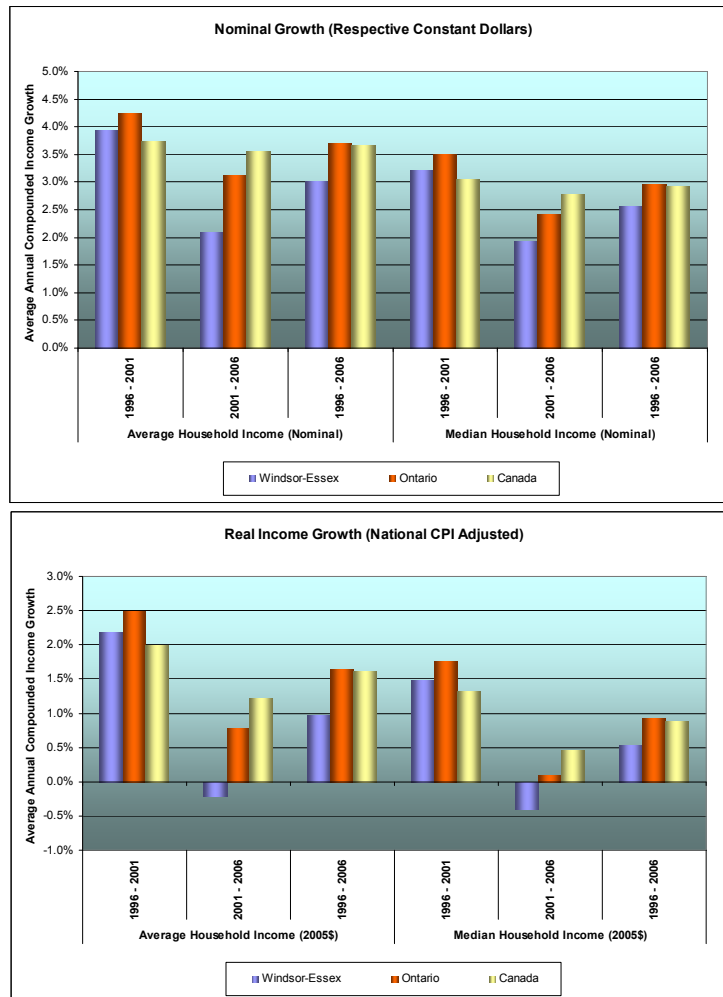

Sources: Statistics Canada

Figure 4-30. Historical Regional Household Income Trends

The Windsor-Essex region median household income historically grew at a slower average annual rate of 0.5 percent in real terms and 2.6 percent in nominal terms between 1996 and 2006, according to Statistics Canada. The median household income growth has been slower than the provincial and national growth rates of 0.9 percent in real terms and 3.0 percent in nominal terms. An evaluation of the more recent average and median household income trends between 2001 and 2006 reveals that the Windsor-Essex region has experienced increases in the nominal income levels, however, these increases have not kept up with inflation such that the real average and median incomes have decreased.

The overall 2006 distributional average and median household incomes for the various municipalities within Essex Counties, as illustrated in **Figure 4-31**, shows that the city of Windsor's average and median household income levels were below the provincial and national averages, however, the municipalities of Amherstburg, La Salle, Lakeshore, and Tecumseh were all well above the averages. This illustrates that several municipalities within the Windsor region have high income markets groups and thus, may potentially have higher propensities to pay the toll charges required to use the proposed bridge crossing.

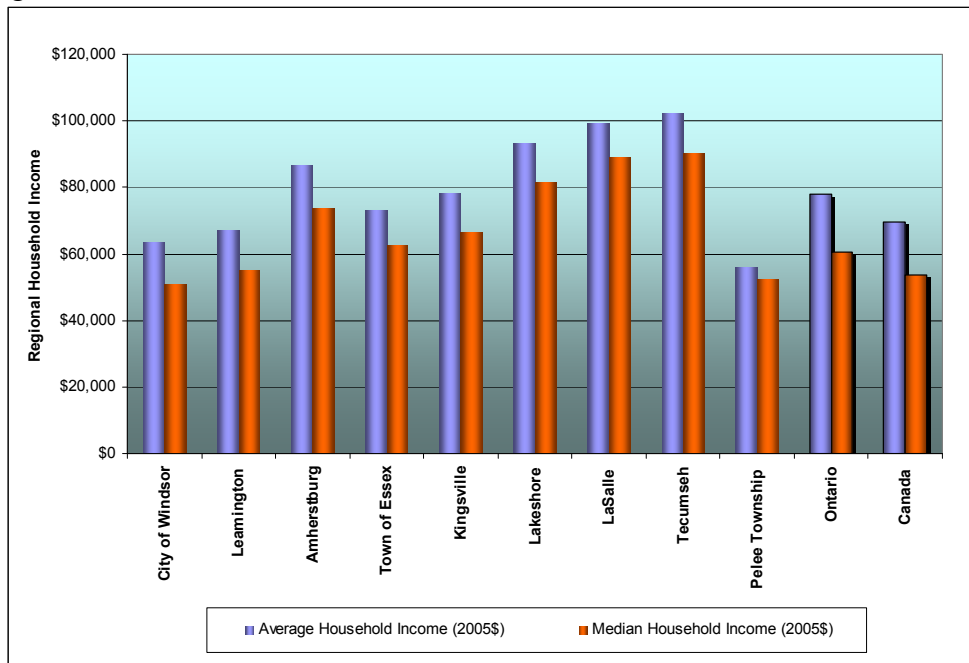

Sources: Statistics Canada

Figure 4-31. 2006 Essex County Municipal Average and Median Household Income

HISTORICAL CONSUMER PRICE INDEX TRENDS

The rate of inflation within the economy reflects the gain or erosion of purchasing power within a region, and provides an estimate for the likely potential and magnitude by which toll rates may be increased within the region to keep up with

the inflationary trends. The growth in the consumer price index (CPI) provides such an indication and the provincial and national historical CPI growth trends are illustrated in **Figure 4-32**. The CPI growth is shown to have decreased by almost half in the early part of the 1990's and remained fairly stable within a narrow range of approximately 2.0 percent average annual growth for both Ontario and Canada between 1990 and 2007. The annual growth of the two indices appears to mirror one another very closely with very few exceptions and more recently has been trending downward.

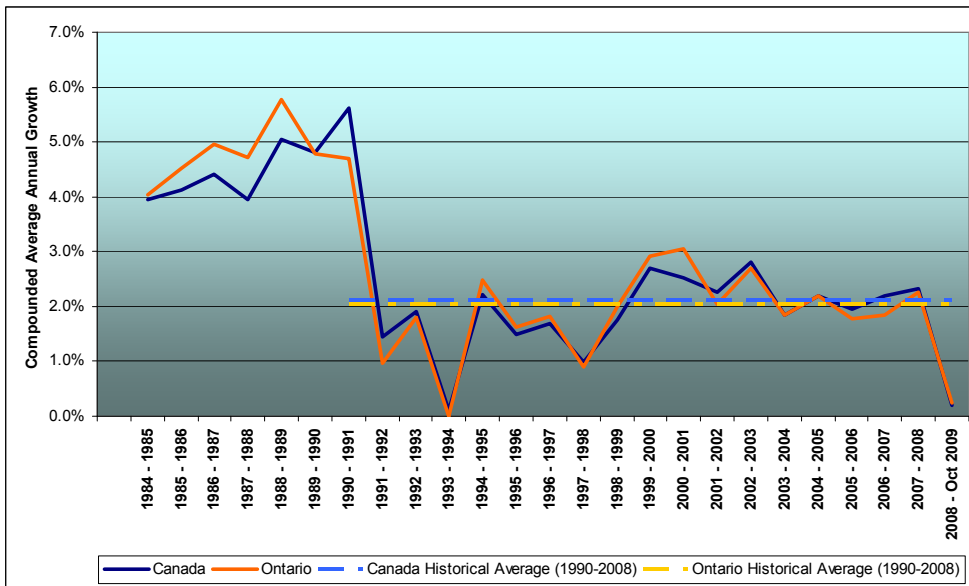

Sources: Statistics Canada

Figure 4-32. Historical Consumer Price Index Growth Trends

REGIONAL GROWTH DISTRIBUTIONAL TRENDS

The following section provides a description of the distributional growth patterns within the Detroit/Windsor region that may influence the traffic and revenue potential for the new proposed bridge crossing. The assessment evaluates several socioeconomic variables at a disaggregate level based on information that was made available to the Wilbur Smith Associates consultant team from both the public and private sector forecasting agencies. The population and employment forecast were analyzed as the two primary explanatory socioeconomic variables for estimating traffic growth in the currently ongoing Detroit River International Crossing Study. These two variables were found to be closely correlated to the majority of other socioeconomic variables within the Detroit/Windsor regions and were also the most readily available at a disaggregate level. **Figure 4-33** and **Figure 4-34** illustrate the overall average annual compounded growth of population and employment, respectively, that is anticipated between 2000 and 2030, according to the various sources within each of the respective counties and census divisions.

2008 Comprehensive Study Projections

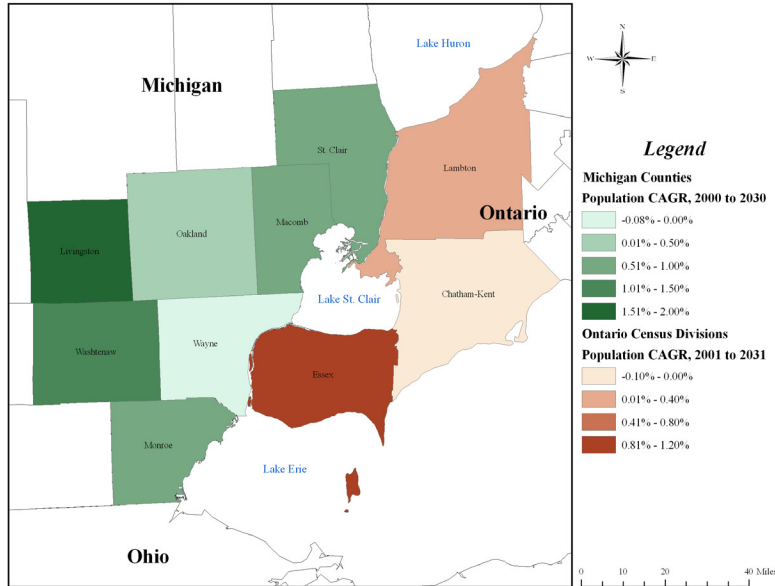

Sources: SEMCOG 2030 RTP and Ontario Ministry of Finance

2009 Revised Projections

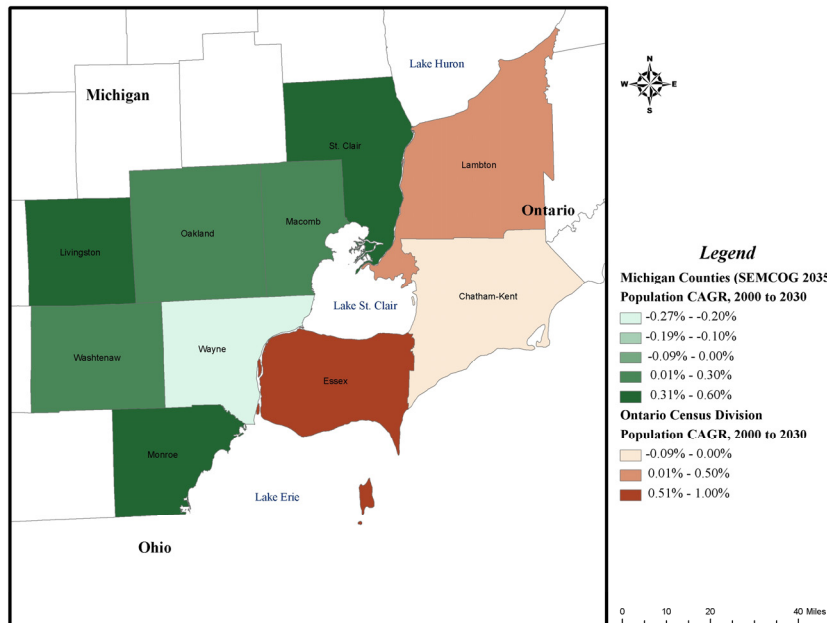

Sources: SEMCOG 2035 RTP and Centre for Spatial Economics

Figure 4-33. Combined Regional Population Growth

2008 Comprehensive Study Projections

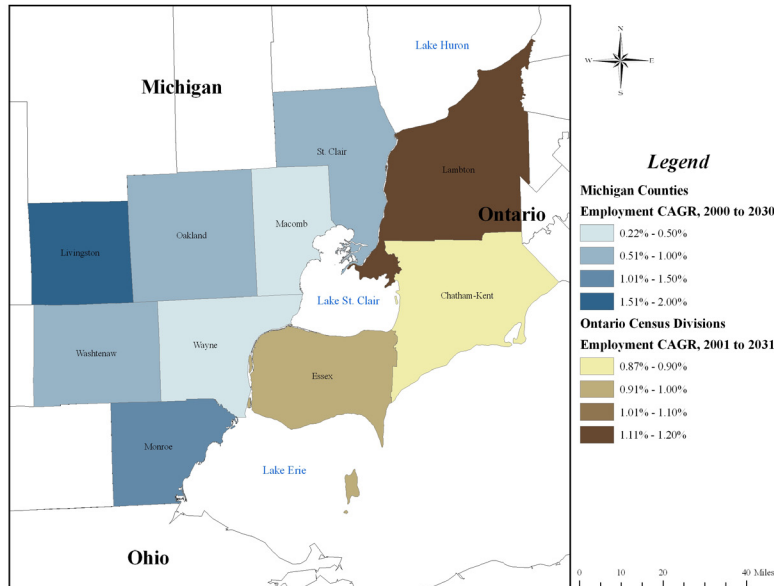

Sources: SEMCOG 2030 RTP and Ontario Ministry of Finance

2009 Revised Projections

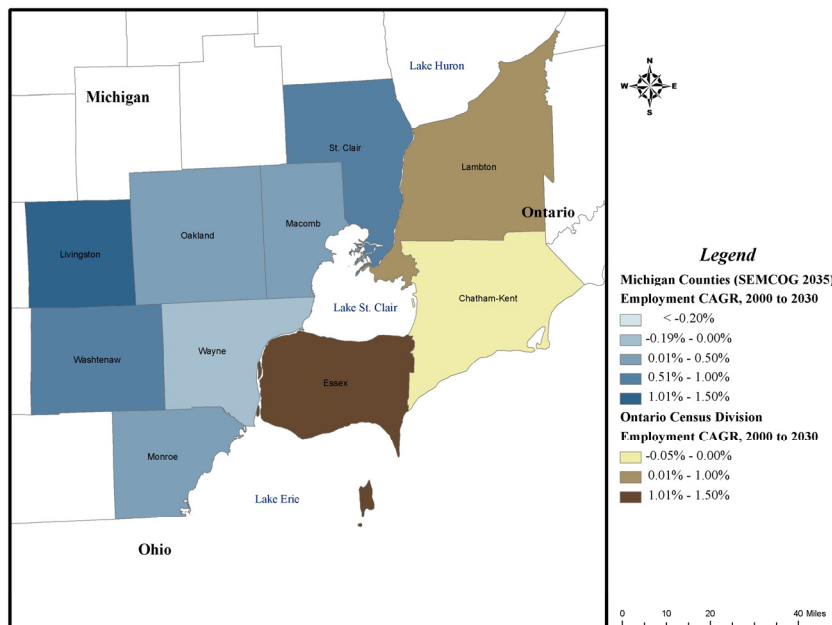

Sources: SEMCOG 2035 RTP and Centre for Spatial Economics

Figure 4-34. Combined Regional Employment Growth

The disaggregate population and employment forecasts obtained for the SEMCOG and census division regions are illustrated in **Figure 4-35** and **Figure 4-36** to highlight where the anticipated growth within the various county and municipality regions is projected to occur.

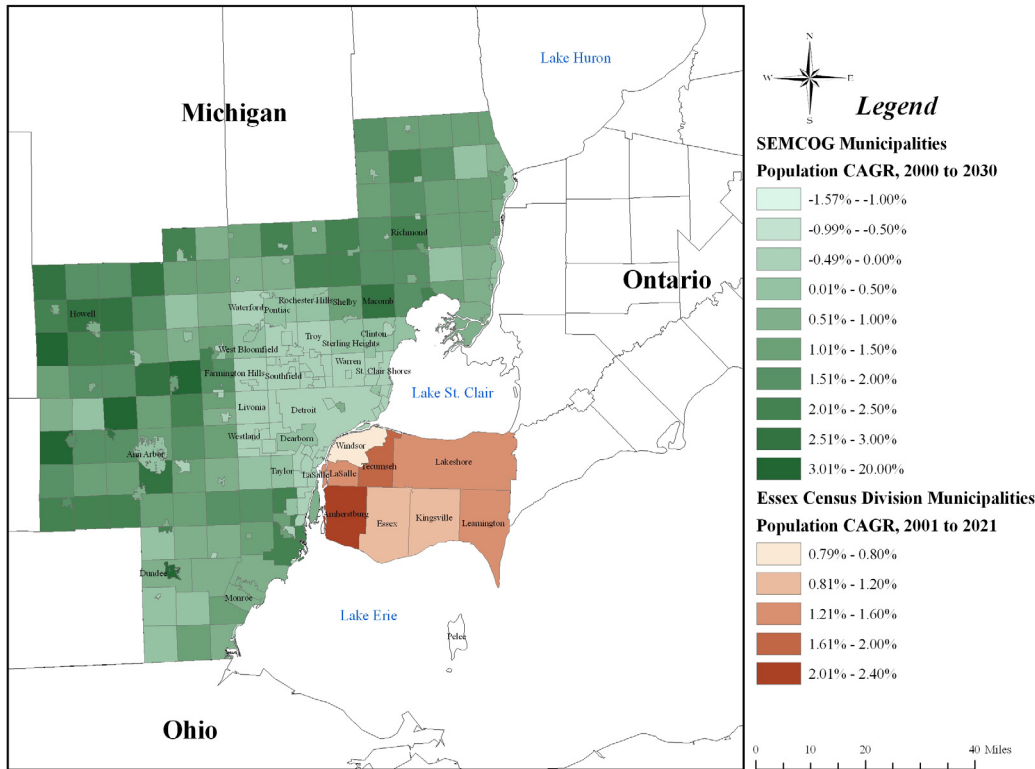

Sources: SEMCOG 2030 RTP and Ontario Ministry of Finance

Figure 4-35. Combined Disaggregate Population Growth

The majority of the future population and employment growth within the SEMCOG region is projected to occur on the periphery within the suburbs of the Detroit metropolitan area. The projected compounded average annual growth (CAGR) of population ranges from between -1.57 percent (River Rouge) and 20.1 percent¹⁰ for SEMCOG municipalities, while the projected CAGR of employment ranges from between -1.26 percent (Harper Woods) to 6.41 percent (Salem Township) for the Windsor municipalities. It is worth noting that the following disaggregate projections

¹⁰ 20.1 percent is a significant outlier for the SEMCOG region, exhibited by a subdivision of Richmond (because the geography only exhibited a population of 1 in year 2000); excluding this outlying point, the maximum compound annual population growth projected for the other municipalities is 5.10 percent (Lyon Township).

were obtained from the 2030 SEMCOG RTP forecasts, since the 2035 SEMCOG RTP new forecasts were only available at the county level at the time of this study. The 2035 RTP forecasts demonstrate a significant downward adjustment to reflect the current economic turmoil and automotive industry restructuring that will likely have a great effect on the Detroit and Windsor economies.

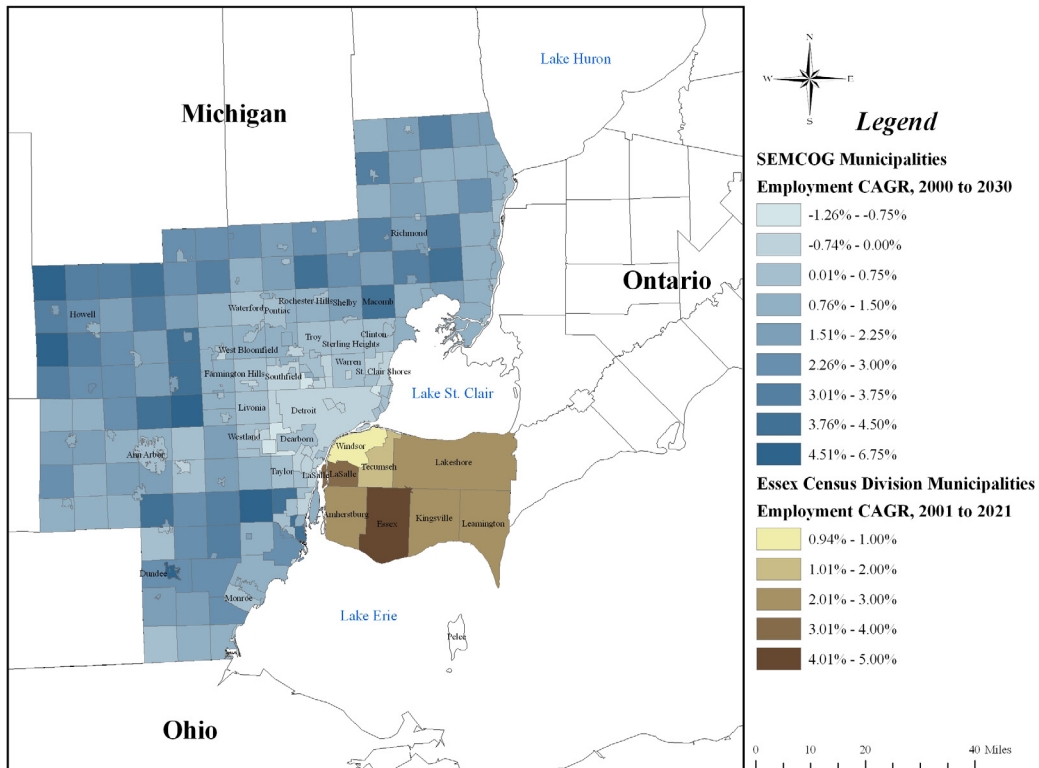

Sources: SEMCOG 2030 RTP and Ontario Ministry of Finance

Figure 4-36. Combined Disaggregate Employment Growth

On the Canadian side, the southern municipalities of Amherstberg and city of Essex within the Essex Census Division are estimated to grow the fastest in terms of population and employment, respectively, at an average annual rate of 2.18 percent and 4.73 percent, respectively. The regions directly around the proposed international crossing within the cities of Detroit and Windsor are projected to account for modest growth between 2000 and 2030, and the majority of the growth is expected to occur in the peripheral regions.

INDEPENDENT ECONOMIC REVIEW

As part of the current study, an independent economic assessment of the projected frontier corridor traffic growth was undertaken to provide a revised profile of anticipated growth of traffic within the Detroit/Windsor region. A comprehensive description of the analysis undertaken is provided in Appendix C and presents a comparison of the corridor growth projections developed previously from the Detroit River International Crossing Study (DRIC-EIS)¹¹, dated September 2005, and the projections developed under the currently ongoing comprehensive Detroit River International Crossing study (DRIC) as they pertain to the forecasting methodologies used and their corresponding results. The comparison provided in the report highlights the similarities and key differences that have emerged in the projected corridor demand traversing the Detroit-Windsor-Port Huron international frontier as a result of differences in the methodological approach, the more recent traffic trends, and the projection of key influential variables.

The independent evaluation of the corridor growth trends as part of the Detroit River International Crossing study for the greater Detroit/Windsor region commenced in February 2008 for Transport Canada by the Wilbur Smith Associates Team, comprised of Wilbur Smith Associates, the IBI Group, the Resource Systems Group, and the Centre for Spatial Economics. This study was conducted in order to provide an update to the corridor growth assessment of traffic demand across the three crossings spanning the Detroit River and the St. Clair River, within the Detroit-Windsor region known as “the Frontier,” which includes the Ambassador Bridge, the Detroit-Windsor Tunnel, and Blue Water Bridge. The analysis applied a multivariate regression analysis approach to forecast several traffic types (same-day trips, overnight trips, and commercial vehicles) to determine their respective traffic volume growth and overall corridor growth of traffic across the frontier. The refresh study incorporated much of the initial efforts performed as part of the initial comprehensive study and updated the forecast databases with the most recent trends and current outlooks.

SUMMARY OF INDEPENDENT ECONOMIC REVIEW

Many socio-economic variables were investigated as part of the initial comprehensive study to evaluate their correlation to the growth in border crossing demand using a multivariate regression analysis approach to test for multiple market segmentations. Three final market segments identified through this extensive initial analysis that were used to determine the traffic volume growth and overall corridor growth of traffic across the frontier were the same-day travelers (with a sub-market segmentation of work/commute and other/recreational), overnight travelers, and commercial vehicles. The

¹¹ Detroit River International Crossing Study, Travel Demand Forecasts. IBI Group/URS Canada for the Canada-United States-Ontario-Michigan Border Transportation Partnership. September 2005.

most significant socio-economic variables found to best describe the historical demand for these three markets are as follows:

- Same-Day Passenger Vehicles (work/commuter): Sum of Michigan and Ontario employment;
- Same-Day Passenger Vehicles (other/recreational): SEMCOG population and Windsor-Sarnia employment with a 911 dummy variable;
- Overnight Passenger Vehicles: Sum of Michigan and Ontario population; and
- Commercial Vehicles: Ontario’s Foreign Trade Turnover (imports plus exports) and Foreign Exchange Rates between U.S./Canada.

The following section briefly summarizes several of these key variables that were updated and used in developing the total expected traffic demand at the three crossings within the study region.

The recent decline in population has led to several adjustments to the population forecasts for the SEMCOG region as well as the Windsor-Sarnia region, as shown in **Figure 4-37**. The overall Michigan and Ontario population and Windsor-Sarnia region population growth forecasts are shown to exhibit short-term declines that will over the long-term normalize themselves back to previously forecasted long-term trends.

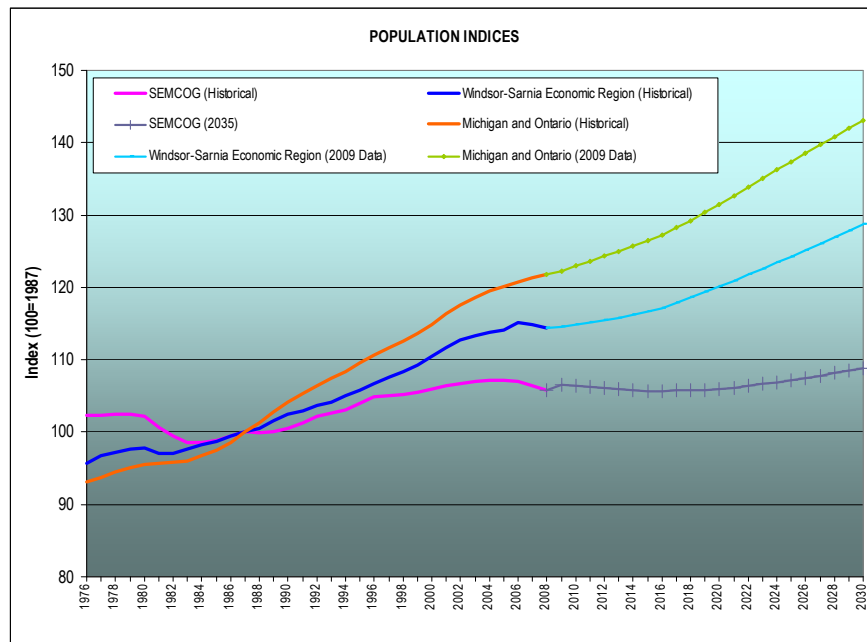

Figure 4-37. Population Growth Indices

The decline in employment within the SEMCOG and Windsor-Sarnia region, as a result of the economic downturns within the United States and Canadian economies, has also

led to some adjustments to the short-term forecasts, as shown in **Figure 4-38**. The employment within the SEMCOG region is expected to experience significant declines over the short and long-term. The current 2035 RTP currently projects that very modest growth between 2009 and 2030 will occur within the region. The Michigan and Ontario employment trends, along with the Windsor-Sarnia region employment trends, show similar declines in the short-term that will eventually trend upward over the long-term. The SEMCOG employment while very relevant to the overall growth within the SEMCOG region was not found to be strongly correlated to the frontier border crossings and, therefore, are not an influential variable to this market. The downturn in the SEMCOG employment is reflected within the regional trip tables and therefore is shown to influence the crossing choices rather than the overall crossing demand. The Windsor Employment however, was shown to be closely correlated to the same-day recreational markets and contributed to the frontier crossing long-term demand.

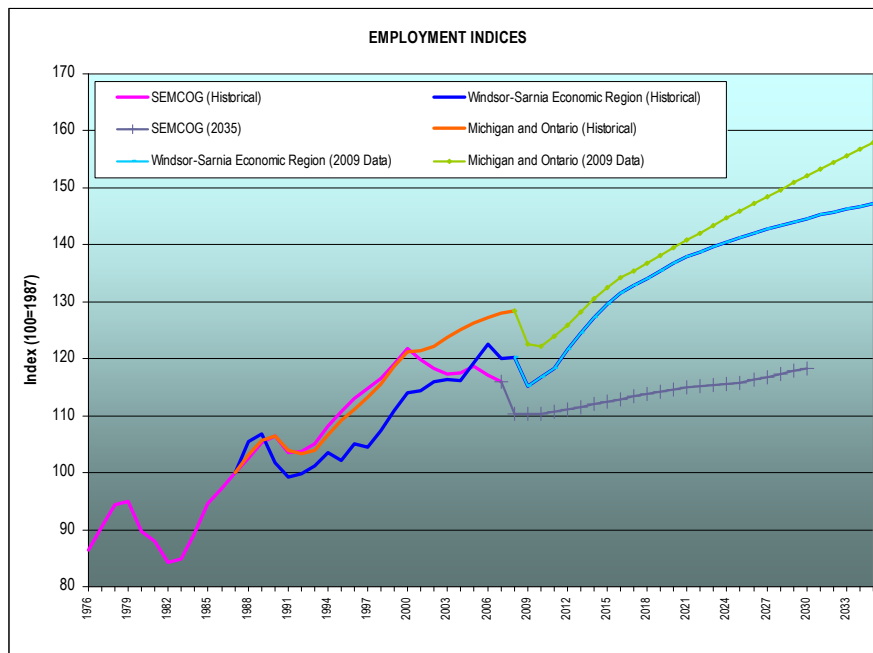

Figure 4-38. Employment Growth Indices

The current trends in the Ontario’s foreign trade turnover (the sum of merchandise exports plus imports) and real U.S. Gross Domestic Product (GDP) has shown recent declines as a result of the economic recessions experienced by both the United States and Canada, as shown in **Figure 4-39**. This downturn is expected to slow the economic growth over the short-term, and the economies are projected to rebound and grow back to previously forecasted long-term levels by 2015, based on forecasts from the C4SE. These variables were found to be closely correlated to the overall long-term commercial vehicle frontier crossing demand and were used to develop the long-term frontier demand.

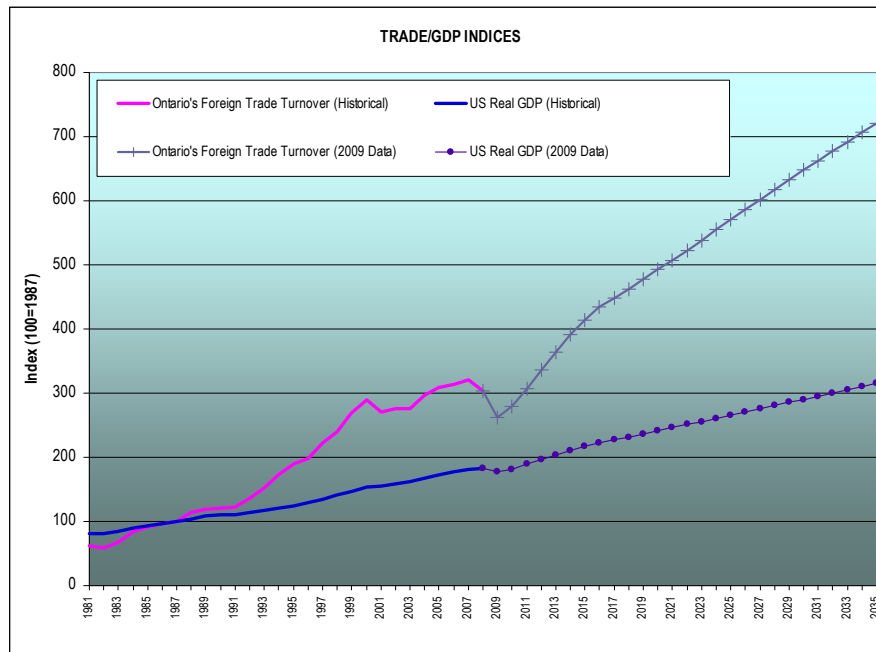

Figure 4-39. Trade/GDP Growth Indices

Figure 4-40 provides a graphical illustration of the temporal comparison of the various traffic type forecasts between the DRIC-EIS study and Investment Grade Traffic and Revenue Detroit River International Crossing study (DRIC). As shown, the DRIC analysis was shown to yield the largest divergence within the 2015 to 2019 time horizon, where the same-day traffic demand was forecasted to be close to 45 percent less than the previously forecasted DRIC-EIS study.

The overall total traffic demand across the frontier is currently 40 percent below the previous DRIC-EIS projections and the revised projections are shown to be close to 35 percent less than previously forecasted by 2015. Beyond the 2015 time horizon, the forecasts were expected to converge, such that the revised forecasts were expected to be approximately 10 percent below the DRIC-EIS forecasts by 2035. This is primarily driven by the reduction in same-day traffic that is expected to continue in the short-term as a result of several factors including the Western Hemisphere Travel Initiative, the collapse and restructuring of the automotive industry, and the economic recession. The return of the same day markets are expected to be gradual and are likely to increase over the long-term as the regional economies diversify and begin recovering. The commercial vehicle markets are, to a lesser extent, dependent on the local economies and are expected to rebound faster such that these are forecasted to be approximately 15 percent below the DRIC-EIS study forecasts by 2015, and approximately 10 percent less by 2035. A detailed description of the factors influencing these forecasted trends are further described in the detailed report in Appendix C.

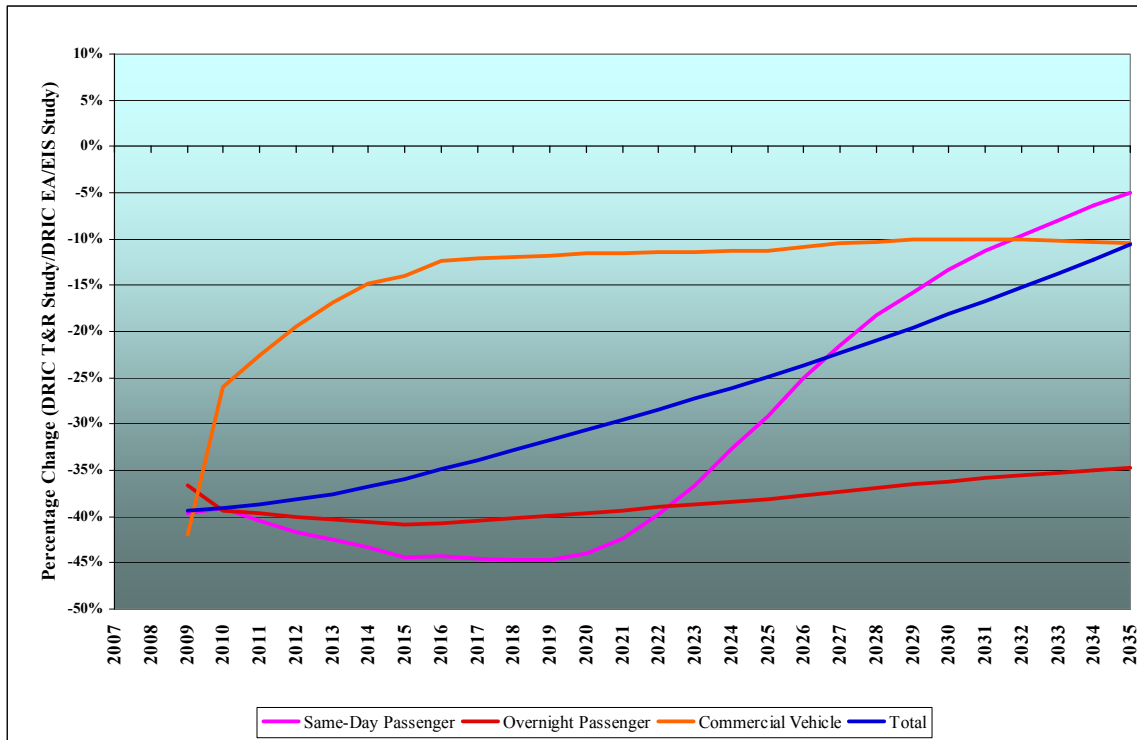

Figure 4-40. Total Frontier Growth Forecast Comparison

CHAPTER 5

MODEL DEVELOPMENT AND ENHANCEMENT

The travel demand model used for this comprehensive study builds upon the model developed originally for the Planning/Need & Feasibility (P/N&F) Study in 2000, and updated later as part of the Detroit River International Crossing (DRIC-EIS) Study in 2004. During the 2008 comprehensive study undertaken for Transport Canada, the model was further enhanced with an independent corridor growth analysis and a comprehensive data collection program that included traffic counts, origin-destination and stated-preference survey efforts, as described in previous chapters. The current model incorporates the most recent highway improvement program and local demographic forecasts, and was calibrated to the 2009 traffic counts collected as part of the refresh study. This chapter provides a detailed description of the methodology and processes implemented to incorporate the relevant data for purposes of calibrating and validating the model used to determine the toll feasibility of the new Detroit River International Crossing (DRIC).

MODELING PROCESS

A brief description of the existing models developed and updated as part of the P/N&F and DRIC-EIS studies is provided to highlight the key structure of the databases that were used as the starting point for this analysis. The modifications and process used to enhance the model and relevant databases to perform the traffic and revenue analysis of the DRIC is then discussed in the context of the general modeling process.

EXISTING TRAVEL DEMAND MODEL

The existing travel demand model used for this study was originally developed in 2000 for the P/N&F study, and was then updated for the DRIC-EIS study in 2004. The P/N&F

regional model was developed from three pre-existing models: Southeast Michigan Council of Governments (SEMCOG) model covering Southeast Michigan, Windsor Area Long Range Transportation Study (WALTS) model covering the greater Windsor area, and the Ontario Ministry of Transportation (MTO) Truck model, which focused primarily on Ontario, but also covered North America.

The previous DRIC-EIS study model was updated from the P/N&F model by moving from a 2000 to 2004 base year to capture the unique events after 2000 (such as 9/11, SARS, and the Iraq War) that, at the time, had influenced the border crossing travel demand. As part of the study, the international crossing trip tables were updated based on the observed trends between 2000, 2004 and 2008, and the model was also enhanced to include a crossing choice logit model that assigned the international trips to the available crossings.

MODEL UPDATE APPROACH

The automobile border crossing traffic has been continuously decreasing since 2000 with an over 40 percent reduction in the Detroit and St. Clair River frontier traffic in 2008, compared to the peak volumes observed in 1999. Commercial vehicle traffic has shown slight fluctuations over the last several years with very little growth in traffic since 1999. The downturn of the auto industry has greatly affected the employment and economic development in the Detroit and Windsor area, and has contributed to the decline in border crossing traffic. The purpose of this model update is to enhance and update the model to account for the changes that have occurred in 2009, and to incorporate recent traffic trends, and to reevaluate the demographic forecasts and the independent corridor growth analysis performed previously in early 2008.

The approach to update the model includes:

- Updating the road network to incorporate the new highway improvement program in SEMCOG's 2035 Regional Transportation Plan (Direction 2035) and in WALTS for city of Windsor;
- Incorporating the selected preferred alternative of the proposed new Detroit River International Crossing (DRIC) into the road network;
- Calibrating the domestic trip tables on both U.S. and Canada sides to reflect current traffic profile;
- Updating the base international trip tables with the comprehensive passenger car origin-destination survey conducted in April 2008;
- Updating the base commercial vehicle trip tables with the national roadside survey/commercial vehicle survey (NRS/CVS) efforts which included a commercial vehicle origin-destination survey performed by MTO in 2006;

- Updating both passenger car and commercial vehicle trip tables based on the 2009 border crossing traffic counts collected as part of this refresh;
- Developing a new discrete choice model to represent the motorists' decision-making behavior based on the comprehensive stated-preference survey conducted in April 2008;
- Calibrating the international and local models to the 2009 levels using the extensive traffic counts collected on both the United States and Canada side of the existing crossing.

MODEL METHODOLOGY AND PROCESS

The travel demand modeling process used as part of this study was similar to the previous P/N&F and DRIC-EIS models given the comprehensive databases that were developed as part of these studies. Further enhancements performed to the key elements of the modeling process are shown in **Figure 5-1**, with more detail provided in Appendix D.

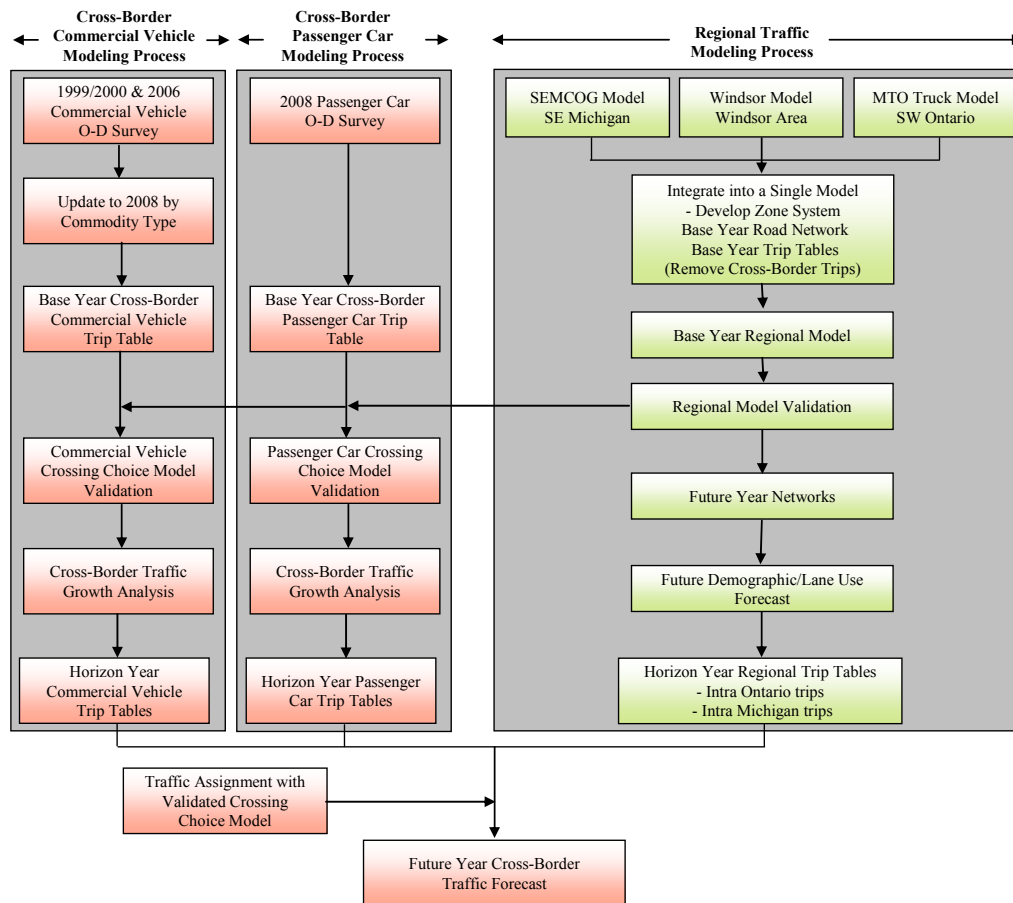

Figure 5-1. Detroit River International Crossing Study Modeling Process Flowchart

The travel demand model consists of a regional demand model and a cross-border traffic model that is further divided into commercial vehicle and passenger car models. Building upon the existing DRIC-EIS study model, the original base year (2004) for the regional model was previously updated to a 2008 base year, and this refresh study updated the models to reflect the 2009 levels. The previous 2008 study base year trip tables for the commercial vehicle and passenger car markets were modified based on the 2008 recent O-D survey data collected within the corridor and the base year regional model was calibrated initially to 2008 traffic counts and travel time data collected. The new 2009 traffic counts and speed profiles collected as part of the refresh were used to verify the calibrated regional models. These models were then used to validate the 2009 crossing choice model, which was developed from the 2008 stated preference survey data.

The future year networks were updated by incorporating the new highway improvement program from the SEMCOG's 2035 Regional Transportation Plan (RTP) and from the WALS on the Canadian side. The preferred alignment for DRIC alternative as directed by Michigan Department of Transportation and Transport Canada was coded into the network and included the approaching roads on both sides of the crossing. The domestic trip tables on the U.S. side, which were previously based on the 2030 SEMCOG RTP, were updated to reflect the new demographic forecast as part of 2035 SEMCOG RTP. As part of the refresh study, the county-wide forecasts from the SEMCOG 2035 RTP were consulted and used to modify the trip tables from the 2008 regional models. This involved recreating the trip generation elements from the 2030 SEMCOG RTP and 2035 SEMCOG RTP demographic forecasts and comparing the changes that were reflected in the new 2035 SEMCOG RTP. Given the refresh nature of this study, the more extensive traffic counts collected as part of 2008 and the calibrated 2008 comprehensive study regional model databases were used as the baseline. The new 2009 spot counts collected within the corridor and the new growth pattern trends outlined in the 2035 SEMCOG RTP were used to recalibrate the models to reflect the current 2009 traffic profiles. The regional trip tables for Windsor area used the DRIC-EIS study trip tables that were updated in 2008 to account for the latest demographic growth trends.

An independent corridor growth analysis was performed as part of this study to evaluate the future growth trend of the frontier traffic. The future cross-border trip tables for both commercial vehicle and passenger car were created by applying growth indices developed in the corridor growth analysis to the base year trip tables. In order to estimate the future traffic demand on the new DRIC, several traffic assignments were conducted with the updated networks and future regional and cross-border trip tables. The regional traffic assignments were performed using a user-equilibrium methodology, while the cross-border traffic was assigned using the validated discrete choice models developed as part of this study.

TRAVEL DEMAND MODEL DEVELOPMENT

This section describes various key elements of the travel demand model that includes the corridor study area zonal system, the time period segmentation, the updated highway networks, and the regional traffic model.

CORRIDOR STUDY AREA AND ZONE SYSTEM

The travel demand model used for this study covers a large area of southeast Michigan and southwest Ontario, as shown in **Figure 5-2**. The area generally extends from west of Ann Arbor and Lansing, Michigan in the United States, to just east of London, Ontario in Canada. The key border crossings within the study include the Blue Water Bridge (BWB) between Port Huron, Michigan and Sarnia, Ontario, the Ambassador Bridge (AMB), and the Detroit-Windsor Tunnel (DWT) between Detroit, Michigan and Windsor, Ontario. The major federal/provincial highways feeding these crossings include I-69, I-94, I-75, and I-96 in Michigan, and Highways 401 and 402 in Ontario.

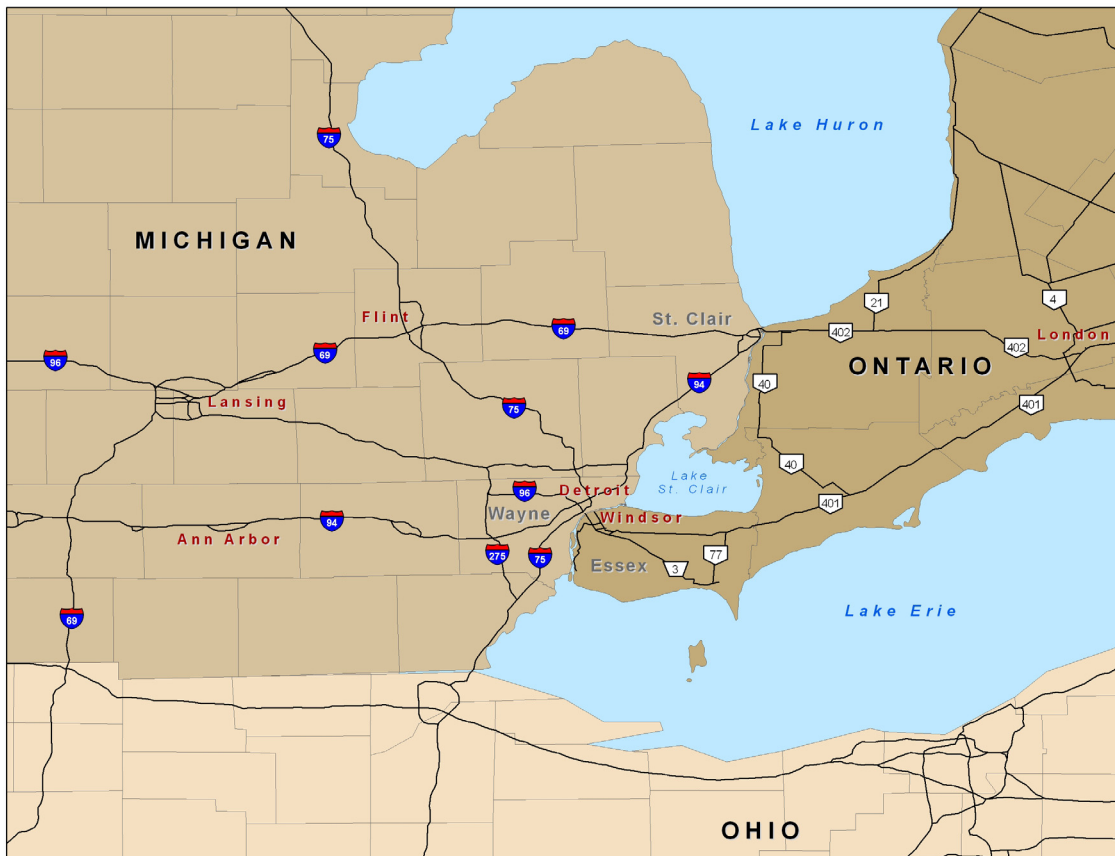

Figure 5-2. Corridor Study Area

The traffic analysis zone system used as part of this study was the same as the initial 2008 DRIC study and included 1,510 disaggregate zones with the following characteristics:

In the United States:

- 322 zones representing Detroit and the northeastern portion of Wayne County, the areas closest to the Detroit-River crossings;
- 304 zones representing Dearborn and the northwestern and southern portions of Wayne County;
- 327 zones representing the counties of Livingston, Macomb, Monroe, Oakland, and Port Huron/St. Clair;
- 6 zones representing the rest of the State of Michigan; and
- 10 zones representing the rest of US and Mexico.

In Canada:

- 464 zones representing the municipalities closest to the Detroit River crossings: the city of Windsor, the Towns of Tecumseh and LaSalle, and the former municipality of Maidstone;
- 26 zones representing Amherstburg;
- 7 zones representing the municipality of Essex;
- 2 zones for each of Kingsville, Leamington and Lakeshore;
- 31 zones representing the rest of Southwestern Ontario (Kent, Lambton, Middlesex and Elgin counties); these zones are based on current or former census subdivisions or municipalities; and
- 7 zones representing the rest of Ontario and Canada.

TIME PERIOD SEGMENTATION

The travel demand developed as part of this model included four time periods:

- A.m. Peak (6:00 a.m. to 9:00 a.m.)
- Mid-day (9:00 a.m. to 3:00 p.m.)
- P.m. Peak (3:00 p.m. to 7:00 p.m.)
- Evening and Night (7:00 p.m. to 6:00 a.m.)

The peak period segmentation used is consistent with the DRIC-EIS study model however, for purposes of evaluating the daily traffic and revenue potential, an evening and night period were developed based on an assessment of the temporal traffic profiles obtained from the detailed traffic counts collected at the three existing border crossings. Additional comprehensive traffic counts were also collected during the 2008 comprehensive study along two screenlines on each side of the Detroit River (as shown in **Figures 3-1** and **3-9** in Chapter 3) to assist in segmenting the time periods for modeling

analysis. **Figure 5-3** provides the temporal distribution of traffic along screenline 1 and 2 in Detroit and indicates that the peak direction of traffic in the morning is southbound for screenline 1 and eastbound for screenline 2. In the afternoon peak, the peak direction is reversed. Traffic counts in Windsor show that the morning peak traffic moves towards the Windsor Downtown area, and showed a peak morning period in the northbound direction for screenline 3, and westbound direction for screenline 4, as shown in **Figure 5-4**.

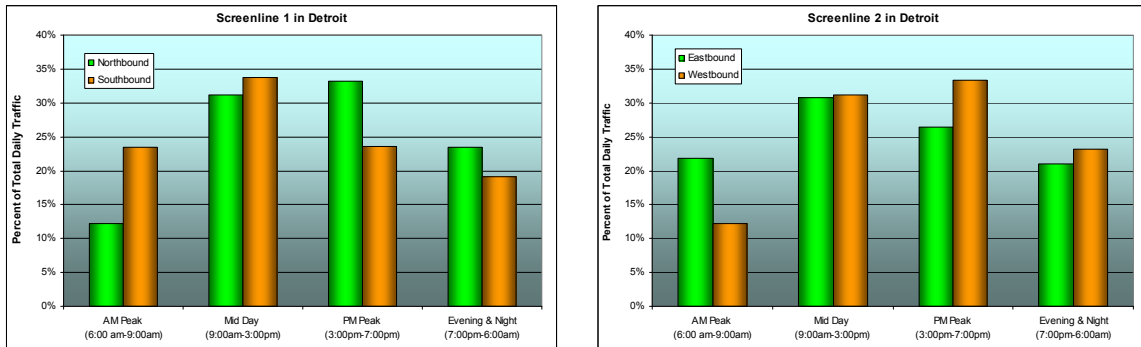

Figure 5-3. Detroit Screenline Traffic Period Distribution

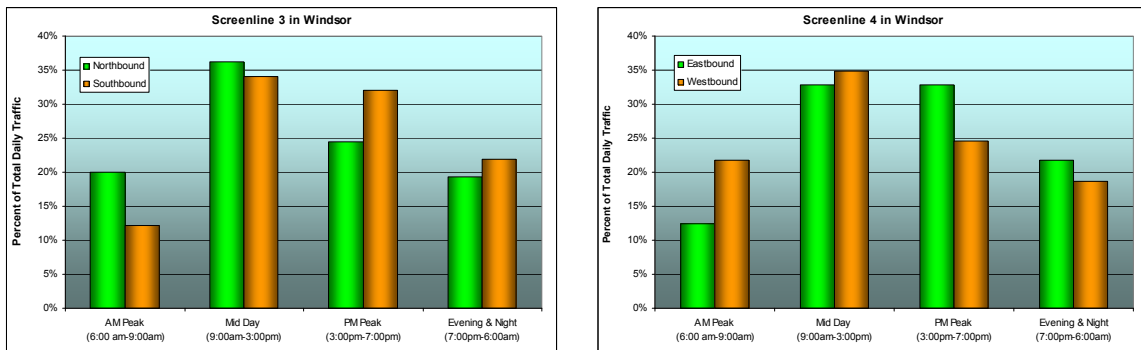

Figure 5-4. Windsor Screenline Traffic Period Distribution

The cross-border weekday traffic profile, by time periods at the three existing crossings, is shown in **Figures 3-29 to 3-31**. The passenger car cross-border traffic at the two existing Detroit-Windsor crossings indicated that the peak direction in the morning is U.S.-bound with a large percentage of traffic Canada-bound in the afternoon peak period. The profiles show that the U.S.-bound peak direction of passenger car traffic continues to be the dominating flow through most of the morning peak until the mid-day. The flows then reverse at this point and show that the Canada-bound traffic becomes the dominating flow in the PM peak direction and this continues through most of the evening and night time periods.

The commercial traffic at Ambassador Bridge does not show a significant peak directional distribution; while the commercial traffic at Detroit-Windsor Tunnel exhibited a similar profile as passenger car traffic which, to an extent is governed by the tunnel’s special commercial vehicle restrictions. Both passenger car and commercial vehicle traffic at Blue Water Bridge did not show a significant peak direction. It is worth noting that a large percentage of the commercial border-crossing traffic occurs at the Ambassador Bridge and Blue Water Bridge during evening and night time periods and therefore, required that a separate period segmentation be developed to model the travel conditions that the commercial vehicles will typically face during these periods.

HIGHWAY NETWORK UPDATE

The highway networks used for this study drew upon the previous 2004 networks developed as part of the DRIC-EIS study and were updated to reflect the recent highway improvements that are now in place, and included the modified future improvement plan as outlined by the various regional transportation agencies. The preferred new crossing alternative and access roads were incorporated in the future year networks, as illustrated in **Figure 5-5**.

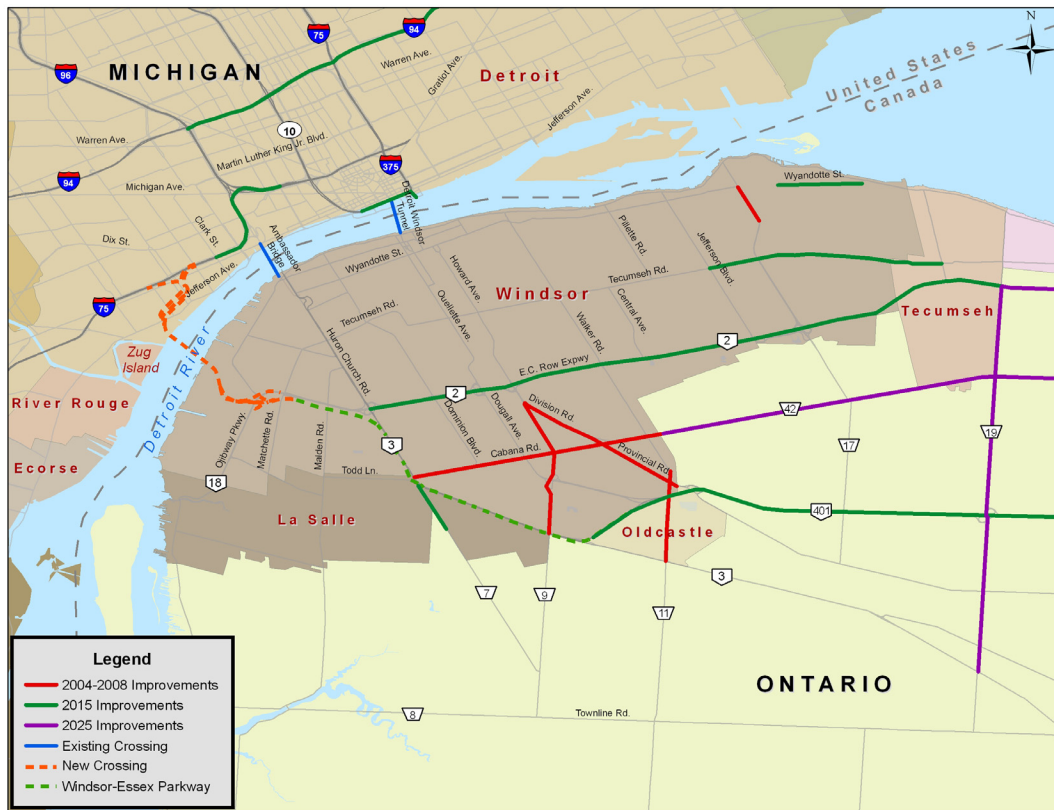

Figure 5-5. Highway Network Improvements

The coding of the new crossing was reviewed to ensure proper network connectivity for all the future year networks with particular emphasis on the main connections to the new crossing from regional highways on either side, namely Windsor-Essex Parkway in Canada and I-75 in the United States. The 6-lane newly constructed Windsor-Essex Parkway will provide a freeway connection from Highway 401 to the new crossing.

The major road improvements incorporated into the 2008 network are identified in **Table 5-1** and illustrated in **Figure 5-5**. Most of the road improvements include the widening of arterial roads in Windsor; none of the improvements are made on the roads directly connecting to the existing crossings. No additional major road improvements were identified on the U.S. side, and this was further confirmed with the local SEMCOG officials.

Table 5-1 Highway Network Updates - 2004 to 2009	
Street Name	Description of Improvements
Dougall Avenue	Segment between Chatham Street and Pitt Street was removed from network
Walker Road	Widened to 4 lanes between Legacy Park Drive to Highway 3
Lauzon Road	Widened to 4 lanes between Wyandotte St. and Tranby Avenue
Provincial Road/Division Road	Widened to 4 lanes from Howard Ave. to City Limits
Cabana Road	Widened to 4 lanes from the CN tracks near the airport to Huron Church Road
Howard Avenue	Widened to 4 lanes from Highway 3 to Division Road
IH 75, IH 96	Various updates according to 2009 construction status of Ambassador Gateway Project

The 2015 and 2035 future networks on the Detroit side were received from the most updated 2035 SEMCOG RTP while the networks on the Windsor side used the same networks as the DRIC-EIS study and were updated with the latest transportation plans outlined by Ontario Ministry of Transportation and city of Windsor. A detailed network improvement list from the 2035 SEMCOG RTP was obtained from SEMCOG, which shows the planned improvements in the SEMCOG region for each of the model years. **Table 5-2** shows the major relevant highway improvements that have been incorporated into the network in years 2015 and 2025. The improvement items listed for 2015 are those improvements planned to be implemented between 2008 and 2015. Similarly, those items listed for 2025 have been planned to be implemented between 2015 and 2025.

Table 5-2 Highway Network Updates – 2015 and 2035		
City	Street Name	Description of Improvement
Windsor (2015)	McHugh Street	Extended from Lauzon Road/Lauzon Parkway to Florence and widened to 4 lanes
	Wyandotte Street	Extended from Riverdale Avenue to Jarvis Avenue /Banwell Road (no widening)
	EC Row Parkway	Widened to from 4 lanes to 6 lanes from Huron Church Road to Manning Road
	Tecumseh Road	Widening from 4 to 6 lanes between Jefferson Boulevard and Lesperance Road
	Huron Church Line	Widening from 2 to 4 lanes between Highway 3 and Sandwich W Parkway
	Highway 401	Widening from 4 to 6 lanes in the Windsor area from 0.5 km east of Highway 3 to 1.0 km east of County Road 42
	Windsor-Essex Parkway	New 6-lane parkway connecting the new crossing to Highway 401
	Highway 402	Major reconstruction of a 20 km stretch of the highway approaching Sarnia area (maintenance/preservation).
Detroit (2015)	Ambassador Gateway Project	Reconstructed freeways and a new interchange for interstates I-75 and I-96, redesigned Ambassador Bridge Plaza
	I-375 Interchange	Improvements to the interchange between interstate I-375 and Jefferson Avenue
	I-94 Widening	Rehabilitation and widening of a 7 mile segment of interstate I-94 from 3 to 4 lanes.
	Jefferson Avenue	Roadway improvements from US-10 to I-375 also facilitating access to the Detroit-Windsor Tunnel
Port Huron (2015)	I-94 Widening	Widening from 4 to 6 lanes from Divided West Belt Opas to Pine Grove Connector
	Pine Grove Road	Widening from 4 to 5 lanes between Hancock Street and Scott Avenue
Windsor (2025)	Division Road	Widening from 2 to 4 lanes from Walker Road to E Puce Road
	Highway 22	Widening from 2 to 4 lanes between Manning Road and Charron Beach Road
	Manning Road	Widening from 2 to 4 lanes between Talbot Trail and Highway 22

There are several other improvements incorporated within the 2035 network were included in the models but are not summarized in **Table 5-2** given that they are not

within the immediate vicinity of the border crossings. Notable future improvements as identified in **Figure 5-5** includes the Ambassador Bridge Gateway project which provides better freeway access from I-75 to the Ambassador Bridge, and the improvement along Jefferson Avenue, which will facilitate better access to the Detroit-Windsor Tunnel.

DOMESTIC TRAFFIC MODELING

The local/domestic car and truck traffic was included in the model to simulate congestion effects along the regional road networks that may potentially influence the travel speeds for the various traveling markets accessing the international border crossings. The local/domestic trip matrices used in this study were based on databases developed as part of the DRIC-EIS study, which included the SEMCOG model on the U.S. side and the WALTS on the Canadian side.

The domestic trip tables used in the DRIC-EIS study and the trip tables received from SEMCOG as part of the 2030 Regional Transportation Plan for the U.S. side were obtained as hourly trip tables during the defined AM, Mid-day and PM time periods. These trip tables therefore required a conversion process be undertaken to expand the data to reflect the corresponding full time period segmentations for purposes of evaluating the traffic and revenue potential of the proposed new crossing. The conversion factors used as part of this trip table expansion effort are further discussed in the following model validation section. The absence of the evening and night period domestic trip tables resulted in the use of the hourly mid-day trip tables distributions which were then factored to approximate the evening and night total traffic based on the observed 2008 traffic counts. The anchor trip tables were developed for years 2004, 2015 and 2035, and the new base year 2008 and future 2025 trip tables were then created through linear interpolation. As part of the refresh study, the 2008 trip tables developed to reflect local regional traffic were also used as the 2009 base trip tables, rather than apply the interpolated 2009 trip tables, and reflected a no growth scenario between 2008 and 2009.

The process undertaken to update the future 2030 SEMCOG RTP model trip tables to reflect the 2035 SEMCOG RTP demographics as summarized in Chapter 4, was developed taking into consideration both the timeframe allocated for the refresh study and the immediate availability of key databases. Initial discussions with SEMCOG staff indicated that obtaining the detailed 2035 SEMCOG RTP model databases in the required timeframes would have been challenging and the extensive validation and recalibration efforts that would be warranted to replicate the model development efforts performed as part of the 2008 comprehensive study could not be accomplished within the study timeframe. As such, a verification process was initiated to recreate the trip generation characteristics implemented as part of the 2030 SEMCOG RTP to establish the relationship between the demographic growth and the generated trips at a county level

within the SEMCOG region. This relationship was then applied to the 2035 SEMCOG RTP demographics to provide factors that could be applied to the 2030 SEMCOG RTP future trip tables to effectively reflect the changes between the two SEMCOG RTPs. The overall process implemented as part of this refresh are outlined in **Figure 5-6**, and the factors applied to the 2030 SEMCOG RTP trip tables used as part of the refresh study are summarized in **Table 5-3**.

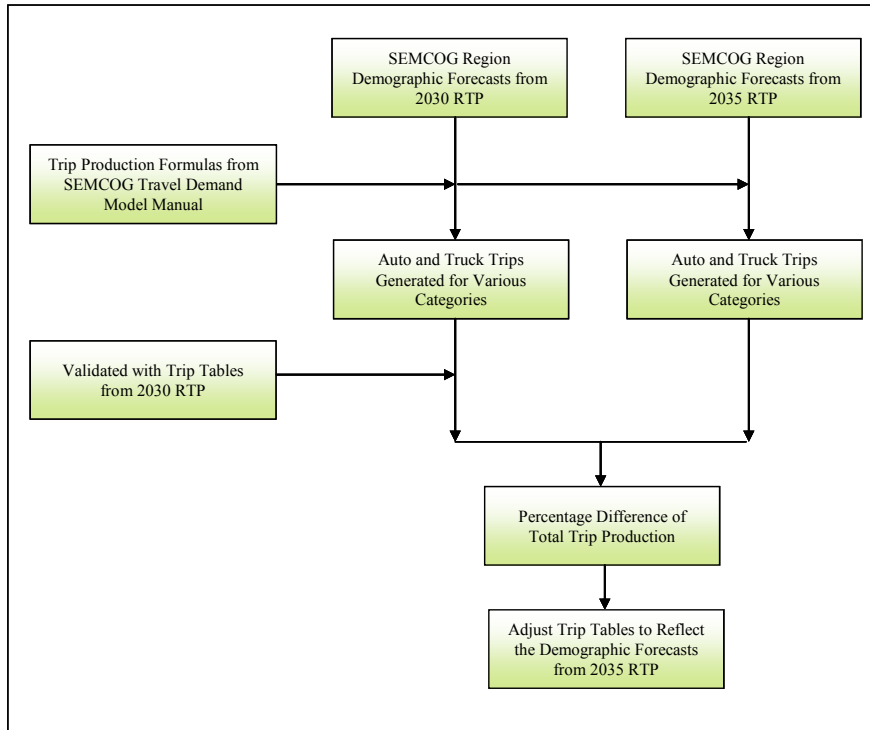

Figure 5-6. SEMCOG Domestic Trip Table Adjustments

Year	Auto	Truck	Population	Employment	Household
2015	0.91	0.92	0.94	0.88	0.94
2025	0.90	0.91	0.92	0.89	0.91
2030	0.90	0.91	0.92	0.88	0.91

Note: These factors were applied to 2030 SEMCOG RTP to reflect the 2035 SEMCOG RTP demographics.

DEVELOPMENT OF INTERNATIONAL TRAVEL DEMAND

This section describes the development of the border crossing travel demand of both passenger car and commercial vehicle traffic for the 2009 base year and the future years. The results from the corridor growth analysis performed as part of this study were used as the basis for the development of the overall growth of the frontier international traffic demand. This analysis included detailed multivariate regression analyses of key factors influencing the growth of passenger and commercial vehicle demand along the Southeastern Michigan and Southwestern Ontario border crossings, as described in detail in Chapter 4. The growth indices developed in the analysis were then used to create the future trip tables for passenger cars and commercial vehicles.

PASSENGER CAR TRIP TABLES

The base passenger car trip tables were developed based on the origin-destination (OD) survey conducted in April 2008, and as described in Chapter 3. The origin-destination (OD) survey was conducted on the three existing crossings of Detroit River and St. Clair River. The survey used intercept and mail-back techniques to capture the current characteristics of traffic at the existing crossings. The OD survey records collected from the field were processed through several steps that included data cleaning, geo-coding, and a comprehensive review. After processing, 893 and 1,606 Canada-bound trips were collected at Ambassador Bridge and Detroit-Windsor Tunnel, respectively, as shown in **Table 5-4**.

Crossing	Direction	2008 Traffic Counts	OD Survey	SP Survey	US- Bound Records	Total OD Records	
						Sample Records	% of Count
Ambassador Bridge	Entering Canada	6,370	893	232	N/A	1,125	17.7%
	Entering US	6,272	N/A	204	884	1,088	17.3%
	Sub-total	12,642	893	436	884	2,213	17.5%
Detroit- Windsor Tunnel	Entering Canada	6,221	1,606	229	N/A	1,835	29.5%
	Entering US	6,469	N/A	125	1335	1,460	22.6%
	Sub-total	12,690	1,606	354	1,335	3,295	26.0%
Blue Water Bridge	Entering Canada	4,258	659	37	N/A	696	16.3%
	Entering US	4,899	814	27	20	861	17.6%
	Sub-total	9,157	1,473	64	20	1,557	17.0%
Total	Into Canada	16,849	3,158	498	N/A	3,656	21.7%
	Into US	17,640	814	356	2,239	3,409	19.3%
	Sub-total	34,489	3,972	854	2,239	7,065	20.5%

Note: Traffic counts shown in this table represent the average traffic from Tuesday to Thursday without the adjustment to account for the impact of construction.

Approximately 659 trips were captured at Blue Water Bridge for the Canada-bound direction, and 814 for U.S.-bound direction. Additional OD information collected during the stated-preference survey (854 records) was also used to supplement the data collected through the intercept OD survey effort. The U.S.-bound traffic profiles and trip records were obtained by transposing the information provided by the survey respondents (only those U.S.-bound trips that indicated that they intended to use one of the study crossings for the return trip were used). This process created another 2,239 U.S.-bound trip records for a total of 7,065 records for use in developing and calibrating the international trip matrices. The trip samples at Ambassador Bridge and Blue Water Bridge finally used to create trip tables accounted for approximately 17.5 percent of the respective traffic counts, while the Detroit-Windsor Tunnel had the highest capture of approximately 26 percent.

Creating the international crossing trip matrices required that the OD trip samples collected be expanded to reflect the full travel market sample based on the collected traffic counts. Expansions were made to the hourly trip tables using the trip records, and customized queries that were built into the OD database to extract origin-destination data. These customized queries grouped origin-destination pairs along with the total number of trips segmented by border crossing and time period to construct a total of twelve trip matrices for the base year (for the four time periods and three border crossings). A detailed summary of the approach implemented in the development of the trip tables is described in Appendix A of this report. As part of the refresh study, the international trip tables were recreated using the same approach, but expanded to reflect the 2009 border crossing counts.

COMMERCIAL VEHICLE TRIP TABLES

The base commercial vehicle trip tables were constructed using the 2006/2007 national roadside survey/commercial vehicle survey (NRS/CVS) performed by MTO, as summarized in **Table 5-5**. This 2006 survey only surveyed commercial vehicle traffic at the Ambassador Bridge and the Blue Water Bridge, thus survey records from the 1999/2000 survey were used for the Detroit-Windsor Tunnel. The NRS/CVS survey contained 3,931 trip records, which were used to construct the base-year truck trip matrices for the Ambassador Bridge and Blue Water Bridge for both directions of travel. A total of 225 trip records were also extracted from the 1999/2000 commercial vehicle survey to build the base year Detroit-Windsor Tunnel trip matrices. As part of the refresh study, the international commercial vehicle trip tables were redeveloped to reflect the 2009 border crossing counts.

Crossing	Direction	2008 Traffic Counts	Observed Sample	% of Count
Ambassador Bridge	Entering Canada	5,764	691	12.0%
	Entering US	6,104	1,459	23.9%
	<i>Sub-total</i>	<i>11,868</i>	<i>2,150</i>	<i>18.1%</i>
Detroit Windsor Tunnel	Entering Canada	251	108	43.0%
	Entering US	159	117	73.6%
	<i>Sub-total</i>	<i>410</i>	<i>225</i>	<i>54.9%</i>
Blue Water Bridge	Entering Canada	2,900	698	24.1%
	Entering US	2,117	1083	51.2%
	<i>Sub-total</i>	<i>5,017</i>	<i>1,781</i>	<i>35.5%</i>
Total	Into Canada	8,664	1,389	16.0%
	Into US	8,221	2,542	30.9%
	Sub-total	16,885	3,931	23.3%

DEVELOPMENT OF CROSSING CHOICE MODEL

The crossing choice model provides a methodology to forecast the potential share of the border-crossing traffic that the proposed new bridge will attract based on several key behavioral parameters identified as part of the stated preference survey efforts undertaken in April 2008. The survey was conducted for automobile drivers, commercial vehicle drivers, and commercial vehicle fleet dispatchers/managers. Following a series of QA/QC processing, a total of 848 automobile responses were obtained with 293 and 122 for commercial vehicle drivers and fleet dispatchers/managers, respectively, as shown in **Table 5-6**. During the survey, each respondent was asked to answer 8 experiment questions, which were compiled as the final observations that were used for model estimation and testing.

Respondent Classification	Respondents	Observations
Automobile	848	6,784
Commercial Vehicle Driver	293	2,344
Commercial Vehicle Fleet Dispatcher or Manager	122	976
Total	1,263	10,104

The models were estimated for three logit choice formulations for both automobile and commercial vehicle respondents, namely, multinomial logit model (MNL), nested logit

model (NL) and mixed logit model (MMNL). The MNL and NL models were tested for several model specifications representing different trip characteristics, as described below. The MMNL was estimated mainly to evaluate the distribution or variation of the various markets' values-of-time (i.e. willingness-to-pay characteristics). Detailed information about the logit model estimation is contained in Appendix B.

MULTINOMIAL LOGIT MODEL

Several utility equation structures were tested for various trip characteristic and demographic segmentations using the variables included in the stated preference experiments. Specification testing included the evaluation of various alternative-specific constants, variables to account for possible strategic bias, and the relationships between the time and cost variables, household income, trip distance, trip frequency, and time-of-day parameters.

The final specification for both the automobiles and commercial vehicles included variables for travel time and toll cost, as well as alternative specific constants for 3 of the 4 alternatives, as outlined in **Table 5-7**. In addition to the base MNL model, several market segmentation models were estimated for the automobile and commercial vehicles to test for variables that included trip distance, trip purpose, trip frequency, time-of-day, and for a separate freeway constant, in order to evaluate the impact of freeway connection to the crossing choice. These segmentations provide insight on the influence that each of these parameters had on the crossing choices for the different markets.

Coefficient	Units	Alternatives			
		New Bridge	Ambassador Bridge	Detroit-Windsor Tunnel	Blue Water Bridge
Travel Time	minutes	X	X	X	X
Toll Cost	dollars	X	X	X	X
Ambassador Bridge Constant	(0,1)		X		
Detroit-Windsor Tunnel Constant	(0,1)			X	
Blue Water Bridge Constant	(0,1)				X

The alternative specification testing showed very little fluctuation from the base model in forecasting the crossing shares and demonstrated that the defined base models adequately captured the key choice determinant parameters, as presented for the automobile and commercial vehicles in **Table 5-8** and **5-9**. Other model specifications are further

described and referenced to Appendix B of this report. The model for the total commercial vehicles was adopted based on the commercial vehicle driver survey sample given that the fleet dispatchers/managers sample size was relatively small.

Coefficient	Units	Value	Std err	t-test
Travel time	minutes	0.089	0.004	-20.8
Toll cost	dollars	0.526	0.016	-33.5
Ambassador Bridge constant	(0,1)	0.475	0.033	-14.5
Detroit-Windsor Tunnel constant	(0,1)	0.395	0.032	-12.5
Blue Water Bridge constant	(0,1)	0.271	0.065	-4.2
Number of observations	6784			
Initial log-likelihood	-7876.454			
Final log-likelihood	-7017.593			

Coefficient	Units	Value	Std err	t-test
Travel time	minutes	-0.068	0.007	-9.6
Toll cost	dollars	-0.057	0.009	-6.6
Ambassador Bridge constant	(0,1)	-0.684	0.053	-13
Detroit-Windsor Tunnel constant	(0,1)	-2.21	0.103	-21.4
Blue Water Bridge constant	(0,1)	-0.648	0.064	-10.1
Number of observations	2344			
Initial log-likelihood	-3058.45			
Final log-likelihood	-2489.73			

NESTED LOGIT MODEL

The nested logit models were estimated using the final MNL specification identified in the multinomial logit model estimation. The nested logit models offer advantages over MNL models in certain choice situations by relaxing the MNL assumption of independence of irrelevant alternatives (IIA). This assumption becomes restrictive when some alternatives in the model are shown to be a close substitute for each other compared to the other choices. For example, in the case of the Detroit-Windsor crossings, the Ambassador Bridge and the Detroit-Windsor Tunnel may be a closer substitute for the new bridge than the Blue Water Bridge, such that changes to the Blue Water operations may have very little impact on the three local Detroit-Windsor crossing, and vice versa.

The nested logit models tested as part of the study included a two-level and a three-level nesting configuration. The two-level nest combined the three crossings of the Detroit River as one nest and the Blue Water Bridge across the St. Clair River as the other nest, as shown in **Figure 5-7**. The three-level nest builds on the two-level, but divided the three Detroit-River crossings into an additional nesting with the Detroit-Windsor Tunnel, as one nest and the proposed new crossing and Ambassador Bridge as the other nest, as shown in **Figure 5-8**.

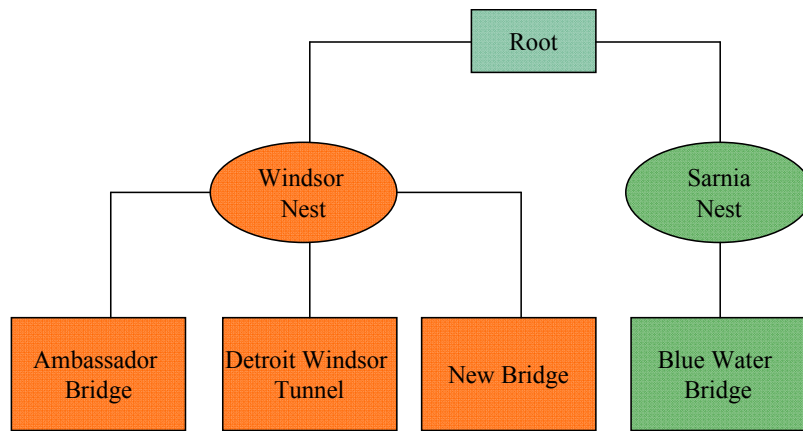

Figure 5-7. Configuration of Two-Level Nesting Structure

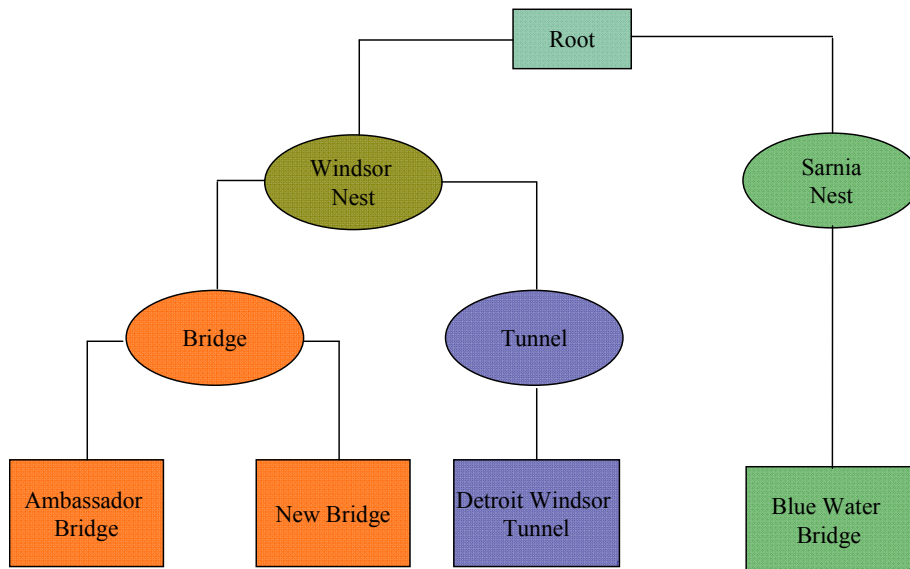

Figure 5-8. Configuration of Three-Level Nesting Structure

The model tests undertaken showed that the three-level nesting structure produced similar results to the two-level nesting structure such that the model coefficients of the two-level

structure only are shown in **Tables 5-10** and **5-11** for automobile and commercial vehicles, respectively.

Coefficient	Units	Value	Std err	t-test
Travel time	minutes	-0.093	0.005	-19.7
Toll cost	dollars	-0.552	0.017	-32.4
Ambassador Bridge constant	(0,1)	-0.48	0.033	-14.5
Detroit-Windsor Tunnel constant	(0,1)	-0.405	0.032	-12.7
Blue Water Bridge constant	(0,1)	-0.904	0.239	-3.8
Nest Thetas				
Nest theta: Detroit-Windsor crossings		0.581	0.082	7.1
Nest theta: Blue Water Bridge		0.581	0.082	7.1
Number of observations		6784		
Initial log-likelihood		-1164.98		
Final log-likelihood		-7006		

Coefficient	Units	Value	Std err	t-test
Travel time	minutes	-0.084	0.013	-6.7
Toll cost	dollars	-0.079	0.018	-4.5
Ambassador Bridge constant	(0,1)	-0.704	0.057	-12.3
Detroit-Windsor Tunnel constant	(0,1)	-2.27	0.12	-18.9
Blue Water Bridge constant	(0,1)	-1.18	0.473	-2.5
Nest Thetas				
Nest theta: Detroit-Windsor crossings		0.684	0.19	3.6
Nest theta: Blue Water Bridge		0.684	0.19	3.6
Number of observations		2344		
Initial log-likelihood		-3737.37		
Final log-likelihood		-2488.87		

BASE MODEL CALIBRATION/VALIDATION

The base-year travel demand model was calibrated and validated using the collected 2009 traffic counts and the crossing choice models were validated to reflect the existing crossing choices of travelers. These efforts were essential to ensure the models used for future year forecast sufficiently replicate the existing travel pattern and traffic conditions

and reflected the travelers' preferences and decision-making behaviors regarding the choice of the various border crossings.

TRAVEL DEMAND MODEL CALIBRATION

The base-year travel demand model developed as part of the 2008 comprehensive study was calibrated using the extensive traffic counts collected in 2008, and some historical traffic volume counts for both the Detroit and Windsor areas. The calibration effort also included an analysis of the travel times generated from the demand models compared to the field speed data collected as part of the ongoing maintenance of traffic simulation (MOTSIM) project conducted by Michigan Department of Transportation (MDOT). Extensive efforts were spent to calibrate the travel demand model to the collected traffic counts and travel time during 2008 comprehensive study. The calibrated demand models developed as part of the 2008 study were considered still valid for this refresh study, and the focus of the refresh focused primarily on the recalibration of the crossing choice models and to verify the local regional distributional trends already established with the models.

Traffic Volume Calibration (2008)

Several construction projects were underway at the time when traffic counts were collected in April 2008. These construction projects forced some detours of traffic to alternative routes such that the normal travel patterns were temporarily changed to some extent during the data collection phase of the initial 2008 study. Several of these major construction projects and their potential impacts on traffic included:

- Ambassador Bridge Gateway Project: the current phase of the project commenced in February 2008 and resulted in the closure of a section of I-75 between Rosa Parks Boulevard and Clark Street, and the interchange between I-75 and I-96. The construction created a number of significant traffic detours from various freeways to the alternative arterial routes and crossings.
- Road construction on Highway 401: this project commenced at the end of August 2007 and reduced the number of lanes just east of Highway 3 to just west of Manning Road. The construction at the time, diverted some traffic from Highway 401 to E.C. Row Expressway and Tecumseh Road.
- Construction on the interchange of Dougall Avenue and Highway 401: Dougall Avenue was closed between Highway 401 and Sixth Concession Road. The construction blocked the traffic going directly from Dougall Avenue to Highway 401 and potentially diverted the traffic to E.C. Row Expressway and Huron Church Road.

- Construction on Walker Road: Walker Road was closed to through-traffic between St. Julien and Parkdale Place/Grand Marais Road. This closure diverted traffic from Walker Road to Central Avenue and Howard Avenue.

The traffic volume calibration of the travel demand model, as a result of these significant projects, was more focused on evaluating the overall screenline or cordon line traffic demand characteristics rather than traffic profile on any one individual road. The traffic along the major access roads to the international crossings was reviewed in detail to ensure that the model produce reasonable results along these key routes. The calibration of the trip tables and networks was conducted for the three main time periods, namely a.m., mid-day and p.m.. The hourly trip tables were factored up to represent the total traffic during the corresponding periods using conversion factors received from SEMCOG on the U.S. side and conversion factors for the WALTERS region were calculated based on the 2000 original OD survey. Some adjustments were made to the original conversion factors during the travel demand model calibration process to reflect the more recent changes in domestic travel pattern and total trips observed from recently collected data. The validated factors used in the following traffic forecast are shown in **Table 5-12**.

Region	Time Period	Factor
WALTERS	AM (6:00 a.m. - 9:00 a.m.)	40%
	Mid Day (9:00 a.m. - 3:00 p.m.)	15%
	PM (3:00 p.m. - 7:00 p.m.)	29%
SEMCOG	AM (6:00 a.m. - 9:00 a.m.)	43%
	Mid Day (9:00 a.m. - 3:00 p.m.)	14%
	PM (3:00 p.m. - 7:00 p.m.)	26%

As mentioned above, the Ambassador Gateway project created significant detours for travelers accessing the downtown and international border crossings and likely influenced the east-west traffic to take north-south routes, or vice versa. The two original screenlines in Detroit were combined to form a complete cordon line to encompass the whole downtown area, which included the two existing Detroit River crossings and the proposed new crossing. The construction projects in the Windsor area were shown to have very little impact on the directional changes of traffic, such that the two original traffic count screenlines were preserved for the travel demand model calibration. The location of the cordon line in Detroit and the two screenlines in Windsor used for calibration are shown in **Figure 5-9**.



Figure 5-9. Location of Model Validation Screenline and Cordon Line

The calibration results are presented in **Figure 5-10**. As shown, the percentage of differences between the model volumes and traffic counts are within the acceptable ranges for the cordon line in Detroit and both screenlines in Windsor. The maximum desirable deviation ranges for screenlines were proposed in the document, “NCHRP 255: Highway Traffic Data For Urbanized Area Project Planning and Design,” which was published by the Transportation Research Board, and is recommended in “Model Validation and Reasonableness Checking Manual,” which was prepared for the Federal Highway Administration in 1997.

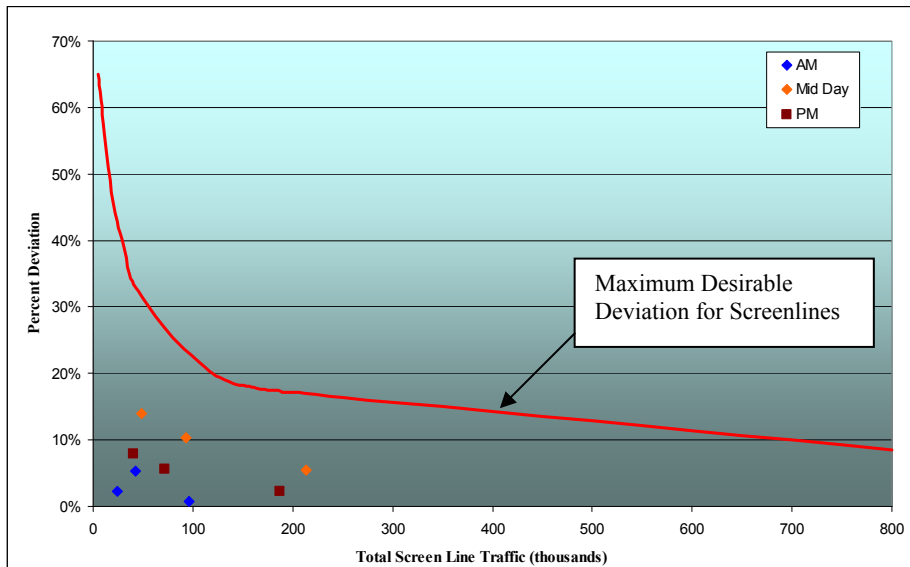

Source: NCHRP 255, Page 41 (Cited in FHWA, Calibration and Adjustment of System Planning Models, Dec. 1990).

Figure 5-10. Travel Demand Model Validation Results

Travel Time Calibration (2008)

Another element in travel demand model calibration included an evaluation of the travel time prediction of the model compared to observed travel times/speeds. Huron Church Road in Windsor is the main connecting road to the Ambassador Bridge, and currently has several signalized intersections between Highway 401 and entrance to the bridge. These signalized intersections meter the traffic from Highway 401 and have, in some cases, historically caused congestion and bottlenecks along the corridor as local traffic and the international traffic interact. Under the proposed new crossing configuration, the split at the E.C. Row Expressway will become a decision point for U.S.-bound travelers to either take Huron Church Road/Ambassador Bridge or the proposed new crossing. As such, the travel time prediction for the section of Huron Church Road between E.C. Row Expressway and Ambassador Bridge entrance required further consideration and analysis.

The observed travel time data were obtained from detailed field surveys conducted in 2006 by the IBI Group. While the auto border crossing traffic on Huron Church Road has decreased since its peak in 1999, truck traffic and other local demand appears to have remained stable such that typical road conditions have also remained stagnant. **Table 5-13** shows the comparison results between the observed and modeled travel time for both to Canada-bound and to U.S.-bound directions. The comparison indicated that the model produced reasonable travel time predictions for all the time periods and both directions, except for the p.m. period in the Canada-bound direction. The field data showed that the average speed in this direction and time period was 21 miles per hour (34 kilometers per hour) in 2006, which is relatively low compared to more recent field observations and the model, which showed the speed to be approximately 27 miles per hour (44 kph).

Period	Observed (mins)		Modeled (mins)		Modeled / Observed	
	To Canada	To US	To Canada	To US	To Canada	To US
AM Peak	3.8	3.8	3.9	4.0	1.01	1.05
Mid-day	4.2	3.8	4.0	3.9	0.96	1.03
PM Peak	6.0	4.0	4.6	4.1	0.77	1.04

The travel time calibration was also made for select facilities within the Detroit area. The Ambassador Gateway project in 2008 caused significant changes in the normal travel pattern, whereby traffic that was originally traveling along I-75 shifted to I-94. As a result, I-94 experienced more congested peak periods with less congested conditions along I-75. The frequent and continuous shift in lane closure due to the various construction projects within the Detroit transportation system also caused fluctuations in traffic conditions on an almost daily basis during the 2008 data collection period. Consideration of these variations was therefore necessary to calibrate the base travel demand model to pre-construction conditions to avoid replicating the short-term impact of the construction projects into the long-term future forecast. The observed travel time information used for model calibration was obtained from the ongoing maintenance of traffic simulation (MOTSIM) project conducted by Michigan Department of Transportation (MDOT) that included data collected in 2006 that was used to calibrate their regional simulation model. The obtained information was the best and readily available pre-construction data that provided some indication of the travel times within the system, although it was recognized that regional traffic has continuously been declining within Detroit area since 2006. The data collected in 2006 showed that congestion was confined to a select few locations and did not last over the duration of the defined peak periods (the average speeds along the three routes evaluated were all above 50 miles per hour).

The three travel time routes evaluated for calibration purposes, as shown in **Figure 5-11**, were selected to describe the typical travel times to the Ambassador Bridge from several regions in the northern, north-western, and western directions. The routes reviewed the travel times along I-75 west of the Ambassador Bridge, along I-75 north of Detroit CBD, and I-96. The travel time comparisons are presented in **Tables 5-14** and **5-15** for the a.m. peak and p.m. peak, respectively. The results indicate that the model travel times are comparable and slightly underestimate the observed travel times in most cases, except for three movements in the p.m. peak. The underestimation of the modeled travel times compared to the 2006 observed travel times, to some extent, reflects the further decrease of traffic within the Detroit area, given that the travel demand model databases were calibrated to 2008/2009 traffic levels.

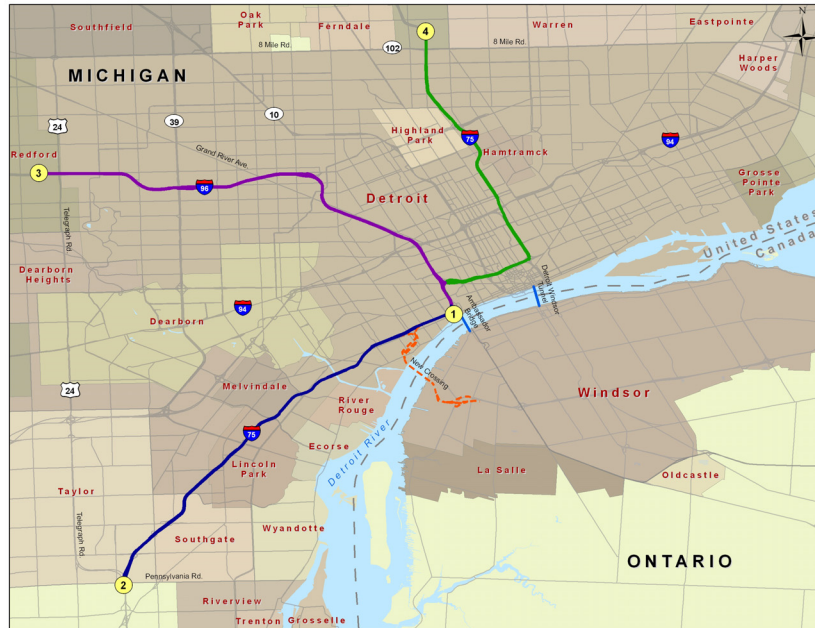

Figure 5-11. Travel Time Routes for Model Validation

**Table 5-14
Travel Time Validation in Detroit - a.m. Peak (mins)**

Movements		Observed	Modeled	Modeled / Observed
Ambassador Bridge to I-75 South	1 to 2	13.2	12.9	0.98
I-75 South to Ambassador Bridge	2 to 1	13.3	13.1	0.98
Ambassador Bridge to I-96	1 to 3	13.8	13.5	0.98
I-96 to Ambassador Bridge	3 to 1	14.8	14.3	0.96
Ambassador Bridge to I-75 North	1 to 4	16.8	15.2	0.91
I-75 North to Ambassador Bridge	4 to 1	14.7	14.3	0.97

**Table 5-15
Travel Time Validation in Detroit - p.m. Peak (mins)**

Movements		Observed	Modeled	Modeled / Observed
Ambassador Bridge to I-75 South	1 to 2	14.7	13.3	0.90
I-75 South to Ambassador Bridge	2 to 1	13.0	13.1	1.01
Ambassador Bridge to I-96	1 to 3	13.8	13.7	0.99
I-96 to Ambassador Bridge	3 to 1	12.8	14.0	1.09
Ambassador Bridge to I-75 North	1 to 4	16.7	16.4	0.98
I-75 North to Ambassador Bridge	4 to 1	15.3	15.9	1.04

CROSSING CHOICE MODEL VALIDATION

The crossing choice logit models estimated from the stated-preference model were calibrated to the current crossings share for each of the existing border crossings prior to future forecast analysis. The multinomial logit model and the two-level nested logit models discussed in the previous model development section were calibrated and the best performing model was selected for use in the future forecasting models, based on the calibration results and other statistical considerations.

Current Crossing Shares

The crossing choice models were calibrated for the four time periods of travel demand model to the 2008 border crossing counts during the 2008 comprehensive study. There were several construction projects ongoing during the data collection in April 2008. Some of the construction was complete or partially complete when this refresh study was conducted, (e.g. most of I-75 section as part of Ambassador Gateway project was open to traffic). During the current economic turmoil, the border crossing travel market exhibited some changes, which were especially evident with the commercial vehicle traffic demand. Detailed border crossing traffic at the two existing Detroit River crossings and the Blue Water Bridge was collected in late November and early December 2009 as part of this refresh study. The crossing choice model was then calibrated to account for the new crossing count profiles.

Table 5-16 shows the crossing shares by direction and time periods for passenger car traffic from the new border crossing counts. These shares were calculated based on the 2009 traffic counts and showed that the Ambassador Bridge and Detroit-Windsor Tunnel had the highest shares during the a.m. peak for U.S.-bound traffic and the p.m. peak for Canada-bound traffic. This reflects in part the heavy commuter market trips going toward the Detroit area in the morning and returning to Canada in the afternoon. Blue Water Bridge showed higher capture of crossing traffic during the mid-day, evening, and night periods which captured approximately a third of the overall crossing traffic during these respective periods. The Ambassador Bridge accounted for approximately 44 percent of the total daily border crossing traffic, with the Detroit-Windsor Tunnel capturing approximately 32 percent, and Blue Water Bridge with 23 percent of the overall border crossing traffic. A comparison of the daily average distribution of shares in the two directions demonstrated very little variation and appears to indicate that motorists consistently use the same crossing for both their U.S.-bound and Canada-bound crossing-border trips.

Table 5-16 Passenger Car Crossing Shares (2009)					
Crossings	A.m. Peak	Mid-Day	P.m. Peak	Evening	Daily
To US					
Ambassador Bridge	53.7%	41.4%	42.2%	38.3%	44.6%
Detroit-Windsor Tunnel	34.7%	25.7%	24.8%	38.2%	30.4%
Blue Water Bridge	11.6%	33.0%	33.0%	23.5%	25.0%
Total	100%	100%	100%	100%	100%
To Canada					
Ambassador Bridge	43.6%	39.2%	47.3%	45.6%	44.2%
Detroit-Windsor Tunnel	35.7%	33.1%	33.2%	36.8%	34.4%
Blue Water Bridge	20.7%	27.7%	19.5%	17.6%	21.4%
Total	100%	100%	100%	100%	100%
Both Directions					
Ambassador Bridge	51.5%	40.3%	45.5%	42.8%	44.4%
Detroit-Windsor Tunnel	34.9%	29.2%	30.3%	37.4%	32.4%
Blue Water Bridge	13.6%	30.5%	24.2%	19.9%	23.1%
Total	100%	100%	100%	100%	100%

The commercial traffic crossing shares are shown in **Table 5-17** varied for the different time periods and daily average. The commercial crossing shares were shown to fluctuate to a lesser extent across the day and showed that the Ambassador Bridge captured the highest share of approximately 65 percent of the total daily crossing traffic with the Blue Water Bridge capturing approximately 33 percent. The Detroit-Windsor Tunnel share given the commercial vehicle restrictions captured a consistently small share throughout the day of approximately 2 percent. It is worth noting that Ambassador Bridge captures the higher U.S.-bound share of commercial traffic than its Canada-bound share while the Blue Water Bridge captures a higher Canada-bound commercial traffic than in the U.S.-bound direction. This observation indicates that more commercial vehicles prefer Ambassador Bridge for the trip going to the U.S. and is, in part, a reflection of the differences in the tolling structures of the two bridges whereby the Ambassador Bridge charges by weight, while the Blue Water Bridge charges by axles. This encourages more long-distance empty-container vehicles to utilize the Ambassador Bridge and full container vehicles to prefer the Blue Water Bridge. The current directional low toll rate at Blue Water Bridge Canada-bound may also contribute to this observed behavior.

Crossings	A.m. Peak	Mid-Day	P.m. Peak	Evening	Daily
To US					
Ambassador Bridge	63.3%	67.3%	67.2%	69.6%	67.5%
Detroit-Windsor Tunnel	2.1%	1.5%	1.5%	0.8%	1.3%
Blue Water Bridge	34.6%	31.2%	31.4%	29.6%	31.2%
Total	100%	100%	100%	100%	100%
To Canada					
Ambassador Bridge	60.4%	61.6%	65.0%	65.8%	63.6%
Detroit-Windsor Tunnel	1.5%	1.8%	3.3%	1.3%	2.0%
Blue Water Bridge	38.1%	36.5%	31.8%	32.9%	34.4%
Total	100%	100%	100%	100%	100%
Both Directions					
Ambassador Bridge	62.0%	64.3%	65.9%	67.8%	65.5%
Detroit-Windsor Tunnel	1.8%	1.7%	2.5%	1.0%	1.7%
Blue Water Bridge	36.1%	34.0%	31.6%	31.2%	32.8%
Total	100%	100%	100%	100%	100%

Crossing Choice Model Calibration

The crossing choice models were calibrated by direction for all the time periods, taking into consideration the different crossing shares by direction, and by vehicle type. The coefficients of travel time and cost were kept constant during the calibration process, while the model constants were adjusted to reflect the revealed (or existing) choice of motorists using an iterative calibration process. The final calibrated crossing choice models from the 2008 study were first applied and showed that the modeled results still match well with 2009 traffic counts (see Chapter 3 for detailed border crossing volumes) and general characteristics within the network. Some minor adjustments to the constants were made to the commercial vehicle crossing choice model, given the large crossing share variations that were observed during the a.m. peak period. **Figure 5-12** shows the validation results for passenger car multinomial crossing choice model and illustrates that the crossing shares produced from the calibrated crossing choice models matched well with observed shares. The differences were within less than 3 percent of the observed shares with the exception of the U.S.-bound direction during night-time period, which was shown to be overestimating the share of Ambassador Bridge by approximately 6 percent with most of this traffic being shown to have been diverted from the Detroit-Windsor Tunnel.

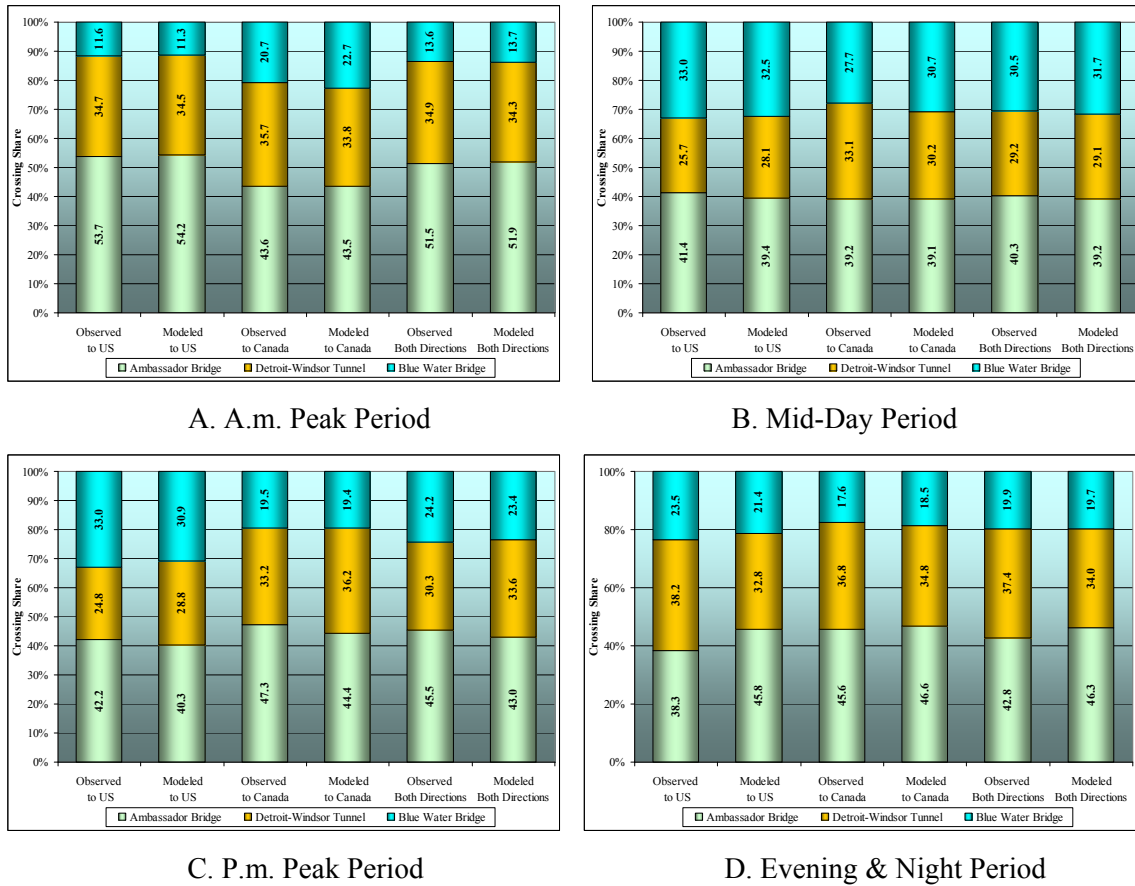

Figure 5-12. Passenger Car Crossing Choice Model Calibration Results

Figure 5-13 shows the calibration results for commercial vehicle multinomial choice models and these showed that the modeled crossing shares ranged within approximately 4 percent of the observed shares.

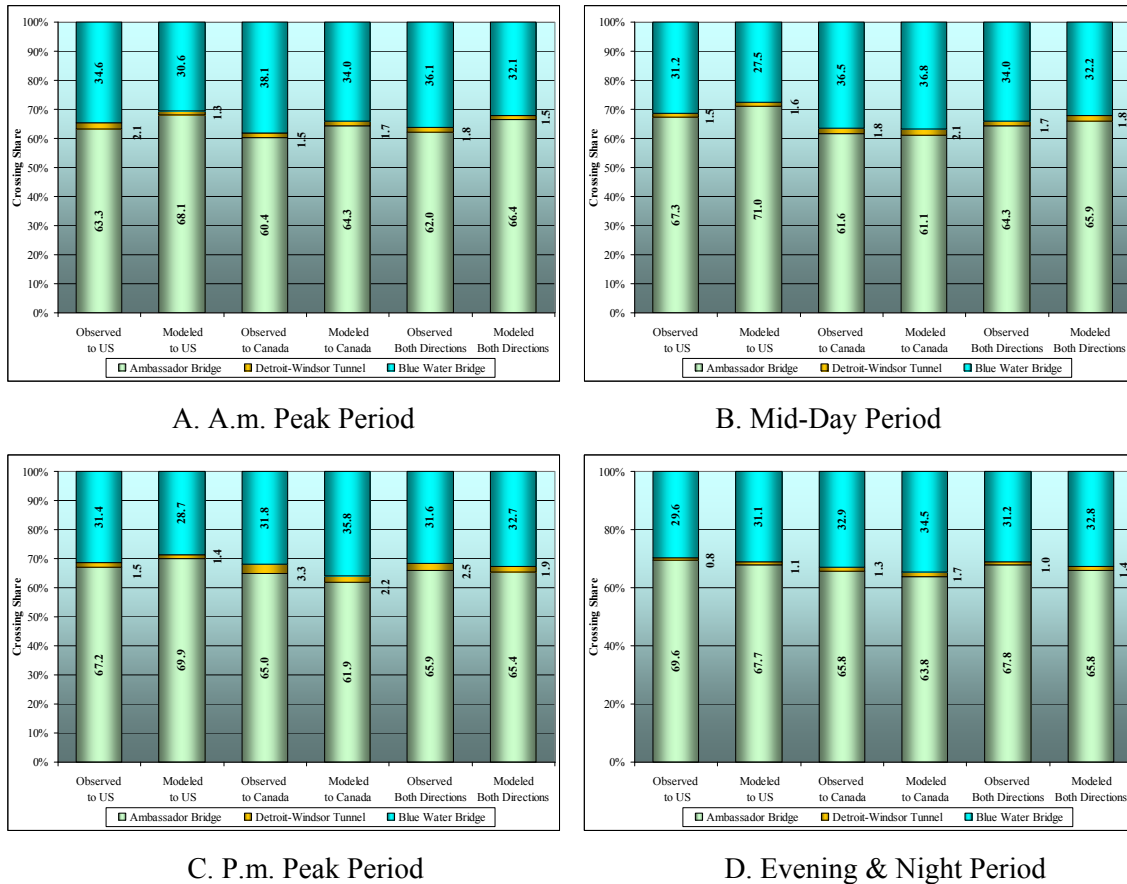

Figure 5-13. Commercial Vehicle Crossing Choice Model Calibration Results

The nested logit model produces similar results as multinomial logit model with just slightly larger errors in the evening and night periods. The final calibrated models of multinomial and nested logit models are shown in **Table 5-18** and **Table 5-19**, respectively. Given both models produce reasonable results and multinomial logit model yielded a slightly better performance, **the calibrated multinomial logit model** was used for the future year forecasts and further consideration as part of the study.

Coefficient	Units	Passenger Car Model Coefficients		Commercial Vehicle Model Coefficients	
		To US	To Canada	To US	To Canada
Travel time	minutes	-0.089	-0.089	-0.068	-0.068
Toll cost	dollars	-0.526	-0.526	-0.057	-0.057
Ambassador Bridge constant	(1,0)	-0.215	-0.075	-0.259	-0.162
Detroit-Windsor Tunnel constant	(1,0)	-0.605	-0.545	-4.271	-4.457
Blue Water Bridge constant	(1,0)	-0.351	-0.501	-1.241	-1.152

Coefficient	Units	Passenger Car Model Coefficients		Commercial Vehicle Model Coefficients	
		To US	To Canada	To US	To Canada
Travel time	minutes	-0.089	-0.089	-0.068	-0.068
Toll cost	dollars	-0.526	-0.526	-0.057	-0.057
Ambassador Bridge constant	(1,0)	-0.300	-0.150	-0.320	-0.208
Detroit-Windsor Tunnel constant	(1,0)	-0.695	-0.635	-4.443	-4.795
Blue Water Bridge constant	(1,0)	-0.734	-0.874	-1.762	-1.527
Nest theta: Detroit-Windsor crossings	--	0.581	0.581	0.684	0.684
Nest theta: Blue Water Bridge	--	0.581	0.581	0.684	0.684

The performance of the selected crossing choice models were also reviewed at a more disaggregate super zone system level, which aggregated the 1510 TAZ into 10 large zones, as shown in **Figure 5-14**. Trips observed from the OD survey for each crossing were aggregated into these super zones and were compared to the modeled trips assigned to each crossing using the final crossing choice model. Comparisons were made in each of the four time periods and were combined into one graph for each crossing for illustrative purposes.

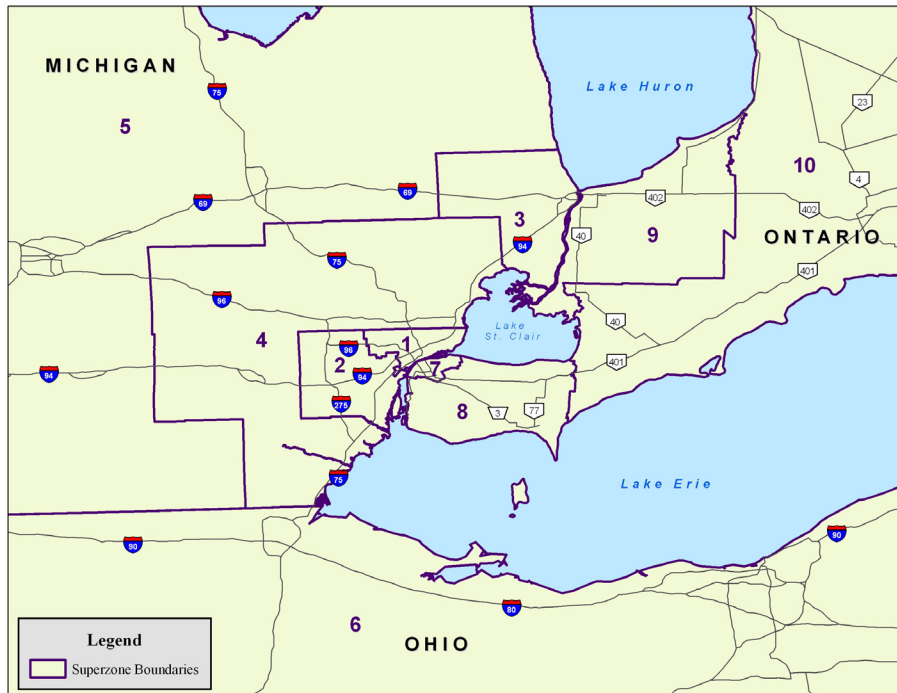

Figure 5-14. Location of Super Zones

Figure 5-15 shows the comparison results of passenger car crossing choice model for the three crossings. The linear regression indicates that the calibrated crossing choice model performed well in replicating not only the overall crossing share between the respective Windsor-Detroit crossings, but also the shares at the disaggregate OD level. The slopes of the Ambassador Bridge and Blue Water Bridge were shown to be close to 1.0, while Detroit-Windsor Tunnel assignment results indicated some over-assigned traffic in some of the low-traffic zones which skewed the relative value of the slope downward. The comparison of the commercial vehicle crossing choice model results, as shown in **Figure 5-16**, indicate that the choice model again replicated the actual crossing shares at the overall and disaggregate levels. Some under-assigned traffic in some of the low-traffic zones for Blue Water Bridge were observed which slightly skewed the slope upward relatively (note: comparison results of the Detroit-Windsor Tunnel are not shown due to the small amount of commercial vehicle traffic using this crossing). The obtained calibration statistics were all within acceptable levels established for transportation modeling and met industry calibration standards with reasonable R-square statistics and residuals.

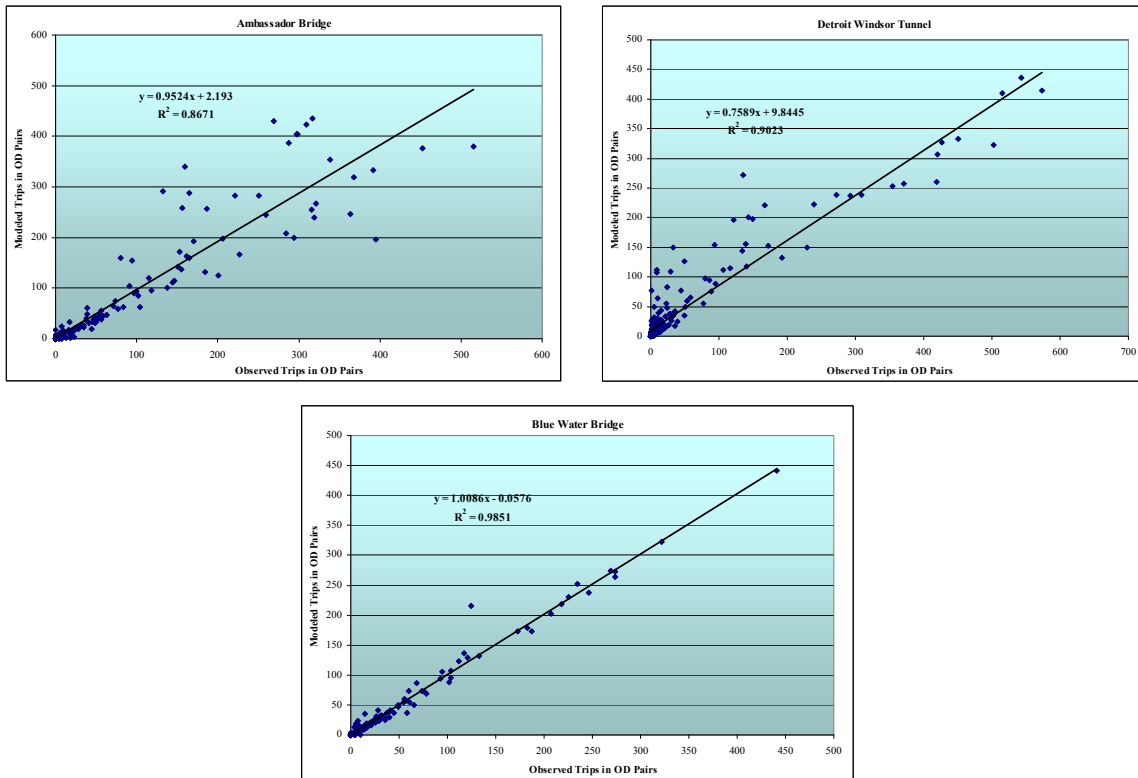

Figure 5-15. Passenger Car Crossing Choice Model Calibration in OD Pairs

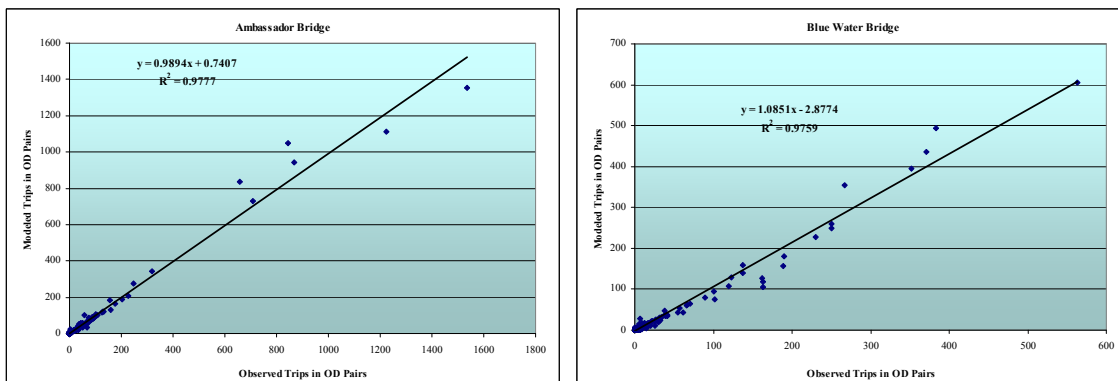

Figure 5-16. Commercial Vehicle Crossing Choice Model Calibration in OD Pairs

THIS PAGE INTENTIONALLY LEFT BLANK

CHAPTER 6

TRAFFIC ESTIMATES

This chapter presents the methodology implemented to generate the traffic forecasts for the proposed Detroit River International Crossing (DRIC). The estimates are based on the modeling process and calibrated travel demand and crossing choice models as outlined in Chapter 5. The following chapter provides a brief description of the selected preferred alternative for the DRIC and the proposed connecting facilities that will provide access. The various key traffic parameters that were used to determine the traffic forecast for the proposed crossing are then described and summarized. As part of the study, the crossing shares of the DRIC and the three existing crossings were modeled and analyzed for the three defined model years – 2015, 2025 and 2035 – under baseline assumptions that are described herein. The results generated from the models were then used to create the projection of future annual transactions for a 50 year time horizon.

PROJECT DESCRIPTION

The preferred crossing alternative and the access roads used as the baseline assumption within the travel demand modeling of DRIC is illustrated in **Figure 6-1**. The final practical crossing alternative X10(B) approved from the Environmental Impact Study (EIS) in the U.S., and the B1 alternative approved from the Environmental Assessment (EA) on the Canadian side were used as the bridge alignment and footprint for the toll plaza configuration. The new proposed bridge crossing on the U.S. side is expected to connect directly to the I-75, approximately 1.8 miles southwest of the Ambassador Bridge, close to Livernois Avenue. Four direct connectors are proposed to ensure the seamless connection of the DRIC with I-75. The new proposed crossing on the Canadian side will be accessed via E.C. Row Expressway, Ojibway Parkway, and the planned Windsor-Essex Parkway, with direct freeway access from Highway 401. The planned Windsor-Essex Parkway will be a below-grade, six-lane freeway with 11 tunnels and

service roads that will provide a continuous and unimpeded connection between Highway 401 in Windsor and I-75 in Detroit.

The proposed new international crossing is located southwest of the Ambassador Bridge and the Detroit-Windsor Tunnel, and its proposed freeway-to-freeway connections on both sides of the border will provide additional mobility to the region and improve the travel crossing times for several key border crossing markets. An analysis of the origin-destination (OD) survey trip distributions showed that a large percentage of international truck traffic are originating/destined from the west along I-75. The freeway-to-freeway connection of the DRIC to Highway 401 on the Windsor side will provide non-stop service and shorter travel times compared to the signalized intersections along Huron Church Road. The DRIC is also located south/west of Windsor, where population and employment growth is expected to occur over the next 20 years in the towns of La Salle and the town of Amherstburg.

It should be noted, however, that the two existing crossings are much closer to the downtown area on both sides of the border, and it is expected that most of the local auto traffic between these two CBD's will likely continue to use the existing crossings. In addition, the north-eastern counties in southeast Michigan and in the towns of Lakeshore and Tecumseh to the east of the city of Windsor are projected to experience continued growth within the forecasted time horizon. The Ambassador Bridge and Detroit-Windsor Tunnel will therefore continue to provide more direct connectivity to the two downtown and these eastern regions and will likely capture the majority of the traffic generated from this future growth. The extent and magnitude of this traffic that the DRIC will capture is, to some extent, also dependent on the border processing times of the existing crossings and the magnitude of travelers that may be willing to back-track past the existing crossing (historically observed trends suggest that the magnitude of this traffic is very marginal).



Figure 6-1. Preferred DRIC Alignment

The addition of the DRIC is not expected to divert much of the current Blue Water Bridge traffic, since the Blue Water Bridge will still hold its advantage of providing shorter travel distances to some local and long-distance markets. In addition, some “soft” characteristics of each crossing that may affect the choice of motorists were considered and included crossing toll rates, border crossing times, ancillary customer services, duty free store, stated preferences, etc. These key parameters were captured and tested in the travel demand and crossing choice models, as briefly discussed in the following sections.

KEY PARAMETERS

The traffic modeling process involved the assessment and development of various key parameters and assumptions. This section discusses some of these key parameters for the new and existing crossing facilities that were identified as having a material impact on the traffic potential for the new proposed crossing. The parameters include toll rates, border crossing times, market segmented corridor growth, weekend traffic profiles, and seasonal traffic variations.

TOLL RATE POLICIES

Current Toll Rate

The existing passenger car toll rates can be paid either by cash or a “commuter” token at all three existing crossings in either U.S. or Canadian dollars. **Table 6-1** shows the current passenger car toll rates for both cash and token payment in U.S. dollars. Tolls are paid by direction and only the Blue Water Bridge assessed different toll rates by direction, prior to the most recent toll increase in 2010. With the exception of the Blue Water Bridge for the U.S.-bound direction, all tolls that are paid in Canadian dollars are higher than the U.S. dollar equivalent. The Blue Water Bridge currently charges the least passenger car toll rates for both cash and token users. The Ambassador Bridge U.S. dollar passenger car toll rates are currently at parity with the Detroit-Windsor Tunnel.

Crossing	Direction	Effective Date	Cash Rate	Discount Rate
Ambassador Bridge	To Canada	February 1, 2009	\$4.00	\$3.50
	To U.S.		\$4.00	\$3.50
Detroit-Windsor Tunnel*	To Canada	December 1, 2009	\$4.00	\$3.50
	To U.S.		\$4.00	\$3.50
Blue Water Bridge	To Canada	September 1, 2009	\$1.50	\$1.50
		January 5, 2010	\$3.00	\$2.00
	To U.S.*	December 1, 2009	\$3.00	\$2.00

*Note: The toll rates for Canadian dollars are higher than paid with U.S. dollars at all crossings except for the Blue Water Bridge U.S.-bound direction as of December 2009. * Reflects rates as of December, 2009*

2. Discount rate at Ambassador Bridge was estimated based on the special discounts for reward card and NEXUS card.

The commercial vehicle toll rates are assessed with several different tolling schemes at the three existing crossings. The Ambassador Bridge commercial vehicle tolling scheme has three classes whereby each class is charged a different per-axle toll rate and also takes into account the weight of the trucks. The Detroit-Windsor Tunnel commercial vehicle tolling scheme uses a gross weight approach with identical toll rates in both directions if paid in U.S. currency and a directional differential in minimum toll rates for tolls that are paid with Canadian currency. The Blue Water Bridge commercial vehicle tolling scheme assesses the toll charges based on the number of axles. **Table 6-2** summarizes the commercial vehicle toll rate schemes currently in place at the three existing crossings. This varied tolling approach at the three crossings results in varying tolls being paid by individual commercial vehicles and warranted that the commercial toll rates used as part of the analysis be weighted to reasonably reflect the actual tolls that each commercial vehicle market would likely encounter. This was based on the existing profile of the commercial markets using the existing crossings that was captured from the OD surveys, and the axle distributions captured as part of the traffic count collection.

Crossing	Effective Date	Toll Rate
Ambassador Bridge	February 1, 2009	Class A: 0-38,000lbs, \$2.75/axle
		Class B: 38,001-56,000lbs, \$3.25/axle
		Class C: 56,001-145,000lbs, \$4.50/axle
Detroit-Windsor Tunnel*	December 1, 2009	To Canada: \$0.030 per 100lbs gross weight
		To U.S.: \$0.030 per 100lbs gross weight
Blue Water Bridge - To Canada	September 1, 2009	\$1.75/axle
	January 5, 2010	\$2.50/axle
Blue Water Bridge - To U.S.*	December 1, 2009	\$3.25/axle

Note: The toll rates for Canadian dollars are higher than paid with U.S. dollars at all crossings except for the Blue Water Bridge U.S.-bound direction as of December 2009

**Reflects rates as of December, 2009*

Historical Toll Rate Increases

The historical toll rate trends for the three existing crossings since 1989 were collected from readily available sources, as shown in **Table 6-3**. The toll rates and token rates at the Ambassador Bridge were held constant between 2002 and 2007, and were adjusted in August 2007 (cash rate went from \$2.75 to \$3.75 and token rate from \$2.50 to \$3.40). Another increase was then made in February 2008, whereby the cash rate was increased to \$4.00 and token rate increased to \$3.60.

Detroit Windsor Tunnel			Ambassador Bridge		
Date Changed	Cash Rate	Token Rate	Date Changed	Cash Rate	Token Rate
2-Sep-02	\$2.75	\$2.00	1-Jul-02	\$2.75	\$2.50
1-Dec-03	\$3.25	\$2.00			
2-Jan-05	\$3.50	\$2.00			
1-Jul-06	\$3.50	\$3.00	18-Aug-07	\$3.75	\$3.40
12-Aug-07	\$3.75	\$3.00			
3-Nov-07	\$3.75	\$3.25	1-Feb-08	\$4.00	\$3.60
1-Dec-09	\$4.00	\$3.50	1-Feb-09	\$4.00	\$3.50
2002-2009 Annual Growth Rate	5.5%	8.3%	2002-2009 Annual Growth Rate	5.5%	4.9%

Several toll rate adjustments also occurred over the past several years at Detroit-Windsor Tunnel as a result of three interim increases that raised the cash toll rate from \$2.75 to \$3.75 and the token rates from \$2.00 to \$3.00 in 2006 and to \$3.25 in November 2007. The toll rates at Detroit-Windsor Tunnel, as of December 1, 2009 increased to \$4.00 for cash and \$3.50 for token patrons. The 2009 toll rates at the Ambassador Bridge in U.S. currency have remained unchanged since 2008. The token rate was estimated to be \$3.50 based on the specified discount rate for the offered reward card and NEXUS card. The calculated average annual growth rate in the toll rates at both crossings was shown to be approximately 6.0 percent, with the exception of the token rate at the Detroit-Windsor Tunnel, which increased by an equivalent 8.4 percent growth annually since 2002.

The historical cash toll rates since 1989 at the three existing crossings are further illustrated in **Figure 6-2**. The Ambassador Bridge toll rates were historically shown to overlap with Detroit-Windsor Tunnel between 1995 and 2002. The more frequent toll adjustment implemented by the Detroit-Windsor Tunnel has since brought the rates to parity between the two crossings. The Blue Water Bridge passenger car toll rates are consistently lower than the two Detroit River crossings and the toll rate of U.S. operation (Canada-bound direction) had remained constant since 1997. The average annual growth rates of the toll rate at the three existing crossings are also summarized in **Figure 6-2**. All three crossings have historically grown at over 5.0 percent for the two periods calculated with the exception of Blue Water Bridge U.S. operations (Canada-bound direction).

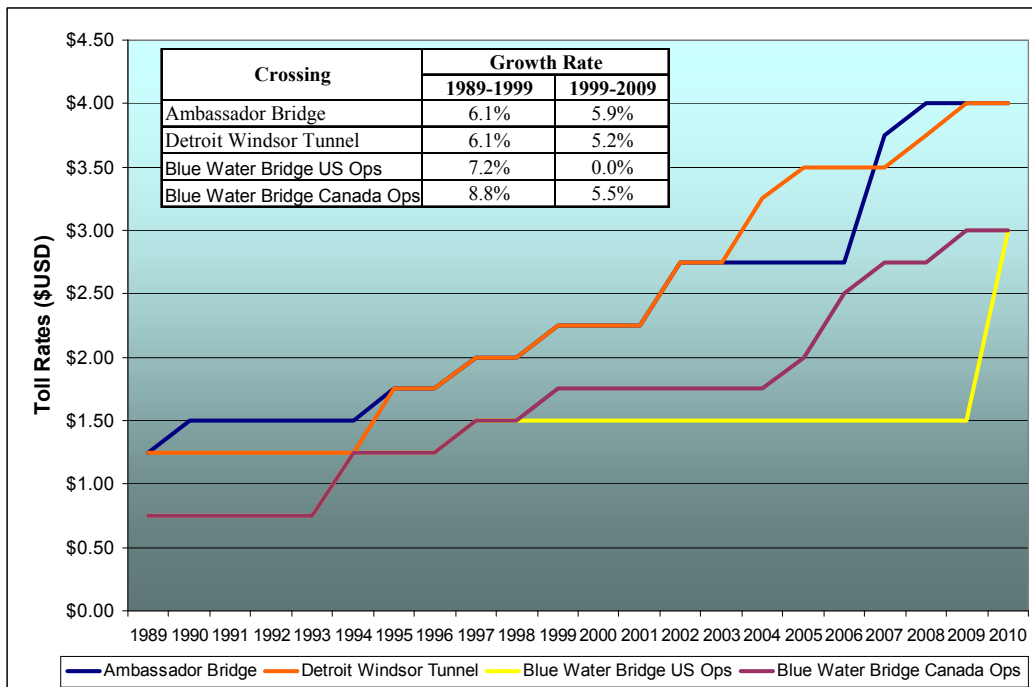

Note: "Growth Rate" reflects average annual compounded growth

Figure 6-2. Historical Passenger Cash Toll Rates at the Three Existing Crossings

The toll rate adjustment policies of the two existing Detroit River crossings are currently not based on any set tolling policy warranted by their respective agencies and, as such, any future increases are very subjective and unpredictable. The recent historical increases were shown to be higher than the average annual growth in both consumer price indices on both sides of the border, and the gross domestic products of the two regions.

For the purpose of travel demand modeling and the future traffic forecasts of the DRIC, the toll rates of the three existing crossings and the DRIC were assumed to grow at the long-term consumer price indices (CPI) demonstrated within the vicinity of the crossings. Standard practice within the toll industry has been to associate the toll rate adjustment with either CPI for the passenger vehicle markets and the growth in Gross Domestic Product per capita for the commercial vehicle markets. The CPI of Ontario and Detroit metropolitan statistical area (MSA) for the past decades, as summarized in **Figure 6-3**, shows that the annual average growth rate (AAGR) of the CPI from 1997 to 2008 is approximately 2.3 percent for Ontario and 2.5 percent for Detroit MSA.

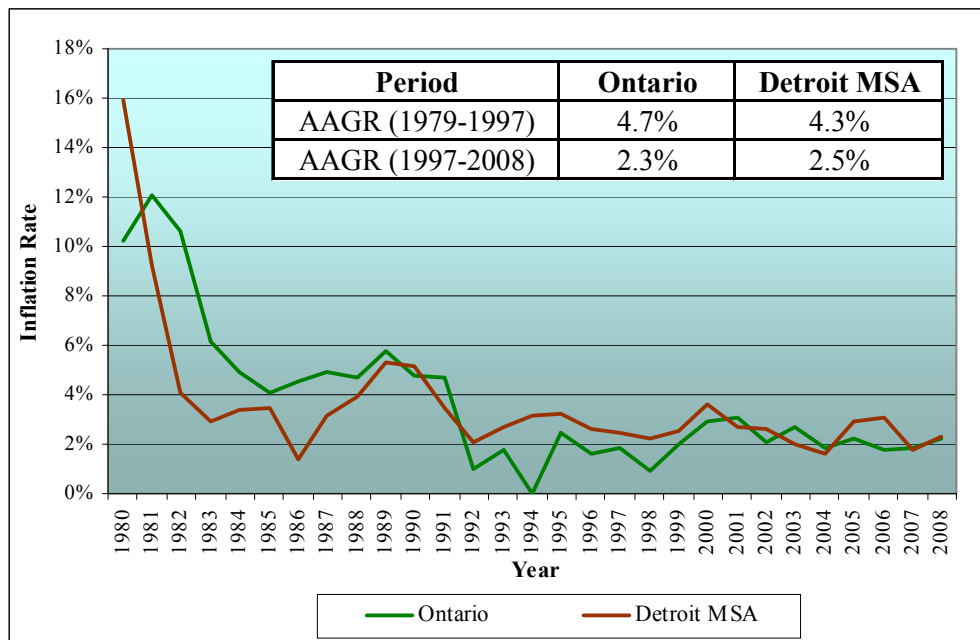

Sources: Statistics Canada, and U.S. Bureau of Labor Statistics, AAGR represents average annual growth rate

Figure 6-3. Consumer Price Index (CPI) of Michigan and Ontario

For the purpose of modeling and forecasting, an approximate average of CPI rates over the past 10 years in Ontario and Detroit was used as a benchmark for the baseline assumption of future toll rate escalations, at an average annual compounded rate of 2.3 percent. The toll schedule on the DRIC is assumed to be always the same as Ambassador Bridge. This is consistent with the historical trends that have shown close parity in toll

rates between the two existing Detroit-River crossings, given the crossing market toll sensitivities and competitive nature of their close proximity.

BORDER CROSSING TIME

Border crossing times are an important factor that can affect travelers' crossing choice decisions. The existing crossing times vary over the day and also vary depending on the number of toll/immigration booths that are open and the inspection staffing levels. In addition, these crossing times are shown to have seasonal variations that are dependent on the traffic demand at the existing crossings. Various sources of data were referenced and compiled to gain an understanding of the historical and recent border crossing time trends at the existing crossings. The border crossing times summarized in this report reflect the total travel time from the initial queue point in the originating country to the point-of-exit from the inspection station in the destined country.

The U.S. Federal Highway Administration (FHWA) conducted a field data collection of the border crossing times at the Ambassador Bridge and Blue Water Bridge in 2001, prior to 9/11, which was focused on commercial vehicles only. This data was cited in the P/N&F study by IBI Group in its working paper, "Existing and Future Travel Demand" dated January 2004. In addition, the Canadian Border Services Agency (CBSA) collected similar information of both autos and truck border crossing delays, based on observations by CBSA staff three times a day. These observations only accounted for delays longer than 10 minutes, such that any delays less than 10 minutes and their respective distribution was not captured in their database. This information was also cited in the DRIC study by IBI Group in the working paper of "Travel Demand Forecasts" dated September 2005 for the Ambassador Bridge and Detroit-Windsor Tunnel only.

Table 6-4 summarizes the border crossing times and delay data presented in the two aforementioned reports. The FHWA study measured the total travel time of border crossing, while CBSA data represents the plaza queuing delay. The table emphasizes the volatility in the border delay times that, to an extent, is also very dependent on the approach used to measure the overall average delay. Ideally, an evaluation of the average delay experienced by every crossing vehicle would provide a good description of the delay, however, no data was available at this level of detail.

Crossing	Direction	FHWA Study - 2001			CBSA Delay - 2003		CBSA Delay - 2004	
		Baseline Time	Average Time	Delay	Mean	Max	Mean	Max
Ambassador Bridge	To Canada	5.7	8.8	3.1	3.9	7.1	1.4	2.4
	To U.S.	12.9	20.4	7.5	25.5	59.5	4.6	14.8
Detroit-Windsor Tunnel	To Canada	NA	NA	NA	2.7	3.9	2.2	4.1
	To U.S.	NA	NA	NA	10.0	17.9	7.4	13.6
Blue Water Bridge	To Canada	5.0	6.2	1.2	NA	NA	NA	NA
	To U.S.	11.1	34.2	23.1	NA	NA	NA	NA

As mentioned in IBI Group's report, the reduction of delay from 2003 to 2004 is due to the opening of new FAST booths in mid 2004.

Recognizing the limitations of the CBSA delay observations, the Ontario Ministry of Transportation (MTO) embarked on another border crossing time collection in collaboration with Turnpike Global Technologies, Inc. The approach included installation of GPS units on the commercial vehicles with GPS detectors placed at strategic locations around the international crossing to track the entering and exiting time of the vehicles. The total time of the tracked vehicles across the crossing provided more detailed and comprehensive data of the potential delay at the crossings. MTO and Transport Canada provided the study team with the travel time data from September 2007 until September 2008 for the three existing crossings by direction as part of the 2008 comprehensive study. Additional data for 2009 was collected and evaluated as part of this refresh study. The data was processed and evaluated at an average monthly level and is summarized for each crossing for the two directions, as shown in **Table 6-5**.

Crossing	Direction	Mean	Max	Standard Deviation
Ambassador Bridge	To Canada	12.7	15.4	1.6
	To U.S.	14.3	17.7	2.1
Detroit-Windsor Tunnel	To Canada	8.3	9.4	0.9
	To U.S.	21.0	26.5	3.8
Blue Water Bridge	To Canada	13.1	16.6	2.1
	To U.S.	16.2	34.9	8.5

In addition to the average crossing time, the maximum time and standard deviation were also calculated for the monthly averages, to depict the reliability of travel time through each crossing. Overall, the U.S.-bound direction was shown to always have the higher crossing times compared to the Canada-bound direction. The Blue Water Bridge exhibited the highest border crossing times for the Canada-bound commercial vehicle traffic and showed the highest variation in border crossing times. The longest average crossing times were shown for the U.S.-bound Detroit-Windsor Tunnel. In addition to the calculated average crossing times, a regression model was also established between the crossing time and level of service (traffic volume/capacity – V/C ratio) to estimate border crossing times in relation to the border crossing demand.

The passenger vehicle crossing times were estimated based on the field observations and limited travel delay runs that were conducted with GPS units by the study team. The field data combined with the analytical estimation based on the crossing distance, average travel speed, and average inspection time, formed the basis of the border crossing times used for this study, as shown in **Table 6-6**. The data was compiled for the four modeling analysis time periods by direction, and showed a minimum crossing time delay for the non-peak directional traffic, and slightly higher crossing delay in the peak direction during the a.m. and p.m. peak periods. An average U.S.-bound delay of 5-minutes was assumed for the a.m. traffic at the Ambassador Bridge, with an 8-minutes delay for the Detroit-Windsor Tunnel, and a 2 minute delay for the Blue Water Bridge. The Canada-bound p.m. traffic was assumed to be slightly less than the a.m. peak direction traffic delay, given that this period has a longer duration and a flatter peaking profile. The border crossing delay for both passenger car and commercial vehicles for the baseline scenario of the DRIC was assumed to have the same profile as the Ambassador Bridge.

Crossing	Direction	A.m. Peak	Mid-Day	P.m. Peak	Evening & Night
Ambassador Bridge	To Canada	5.6	5.6	8.6	5.6
	To U.S.	10.6	5.6	5.6	5.6
Detroit-Windsor Tunnel	To Canada	4.2	4.2	8.2	4.2
	To U.S.	12.0	4.2	4.2	4.2
Blue Water Bridge	To Canada	4.8	4.8	6.8	4.8
	To U.S.	6.8	4.8	4.8	4.8

CORRIDOR GROWTH

The corridor growth analysis detailed in Chapter 4 provided the basis to forecast the future frontier traffic demand within the study area. The final growth indexes were developed based on the multivariate regression analysis, which estimated the frontier

traffic as a function of the various independent/explanatory socioeconomic variables. A separate multivariate regression equation was developed for identified travel markets to determine their respective future traffic demand growth.

As illustrated in Chapter 4, the future passenger car border crossing traffic was forecasted using two market segments – same day and overnight. **Table 6-7** shows the frontier traffic growth indexes for 2015, 2025 and 2035 indexed to 2009 for both passenger car and commercial vehicles. The passenger car traffic is expected to grow over the long-term at approximately 2.6 percent annually between 2009 and 2035, however, uncertainties still remain in the short-term forecast, due to current economic turmoil and auto industry restructuring that may affect the international traffic in Detroit-Windsor area. The commercial vehicle traffic is forecasted to grow averagely at 4.3 percent over the next three decades. The forecast show that commercial vehicle traffic will undergo a significant short-term rebound from the current 2009 levels, which is significantly lower than the 2000-2008 levels.

Vehicle Type	Growth Index				Per Annum Growth Rate (%)			
	2009	2015	2025	2035	2009-2015	2015-2025	2025-2035	2009-2035
Passenger Cars	1.00	1.07	1.41	1.94	1.07%	2.86%	3.25%	2.59%
Commercial Vehicles		1.79	2.42	3.01	10.17%	3.06%	2.24%	4.34%

WEEKEND TRAFFIC AND SEASONAL VARIATION

The travel demand model developed as part of this study was calibrated based on the average weekday traffic profiles within the region. For purposes of estimating the annual traffic potential of the proposed DRIC, considerations were made to account for the weekend traffic profile. The weekend traffic relative to the weekday traffic is typically evaluated to determine the differences in these two markets, based on the existing traffic counts. Seven-day counts were collected at the three existing crossings to capture the weekend traffic profile in April 2008 as part of the 2008 comprehensive study. The April counts are considered to be more representative than the weekend traffic counts made for this refresh study in late November 2009 as detailed in Chapter 3. The two existing Detroit River crossing's weekend passenger car traffic as a percentage of the weekday traffic was shown to be approximately 82 percent at Ambassador Bridge and 85 percent at the Detroit-Windsor Tunnel. The weekend passenger car traffic through Blue Water Bridge was shown to be approximately 33 percent higher than weekday traffic. A review of the weekend commercial vehicle traffic compared to the weekday traffic showed that Ambassador Bridge captured the lowest percentage of approximately 35 percent, while

Blue Water Bridge captured approximately 45 percent, with the Tunnel capturing the highest value of approximately 55 percent.

The international crossing trip tables developed in this study were based on the passenger car surveys conducted in April 2008, and the commercial vehicle CVS/NRS surveys conducted in 2006. The OD sample trips were expanded to the traffic counts conducted in late November 2009 to reflect the most recent traffic profiles and crossing shares. The seasonal variation of the international traffic, especially given the differing markets throughout the year, required careful consideration when projecting the annual traffic. The historical seasonal variations of the three existing crossings are described in more detail in Chapter 2.

The international passenger car traffic typically peaked during the months of July and August, while the low periods were usually between September and February. The magnitude of the monthly variations was shown to be very different among the three crossings. The Blue Water Bridge demonstrated the most significant variation with overall monthly peaking that varied as much as 35 percent higher and 20 to 25 percent lower, compared to the annual monthly average volumes. The Detroit-Windsor Tunnel demonstrated the least variation that only deviated by approximately 5 percent for the peak high month and low months compared to the annual monthly average. The commercial vehicle crossing traffic was shown have a very different seasonal pattern compared with the passenger car markets. The low-volume months were typically in July while the peak months occurred in March, May and October.

CROSSING SHARE ANALYSIS

The calibrated travel demand and crossing choice models were used to project the future crossing shares among the three existing crossings and the proposed Detroit River International Crossing (DRIC). The modeling was initially conducted with both the calibrated multinomial and nested logit models (as described in Chapter 5) for years 2015, 2025 and 2035. The crossing share results presented in this section represent the annual crossing shares of each crossing, which were calculated based on the weekday travel demand modeling results and account for the weekend traffic and seasonal variations.

Figures 6-4 to 6-6 show the crossing-share results with multinomial logit model for passenger car, commercial vehicle markets, and total vehicles respectively. The results are presented for both the “no build” and “build” scenarios. The crossing shares of each crossing under this model configuration were shown to remain similar for the three modeling years with minor variations in both scenarios. This consistency in part reflects the baseline assumptions that remain relatively constant throughout the forecast period.

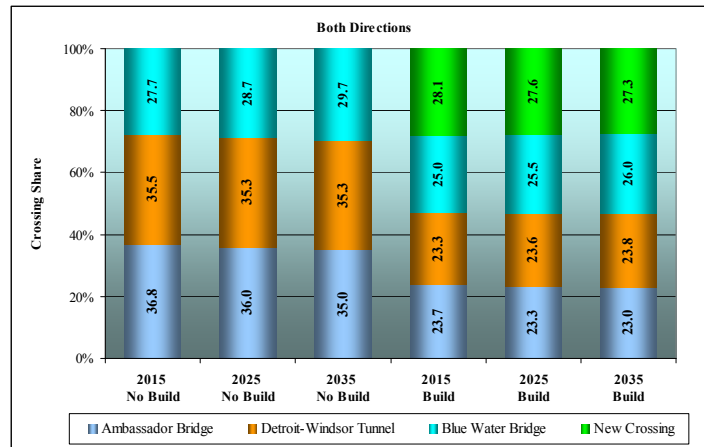

Figure 6-4. Passenger Car Crossing Share with Multinomial Logit Model

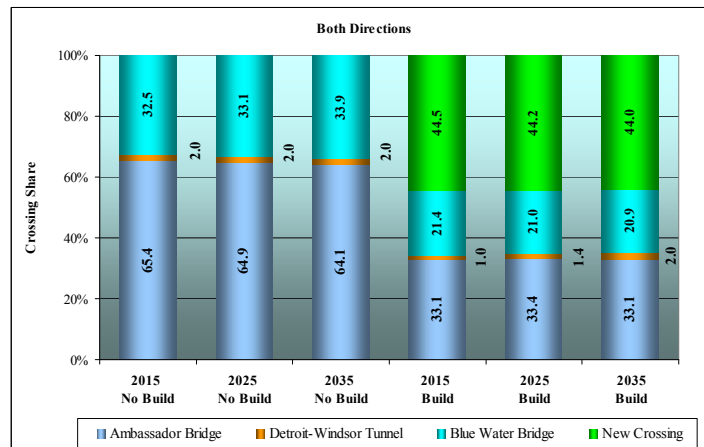

Figure 6-5. Commercial Vehicle Crossing Share with Multinomial Logit Model

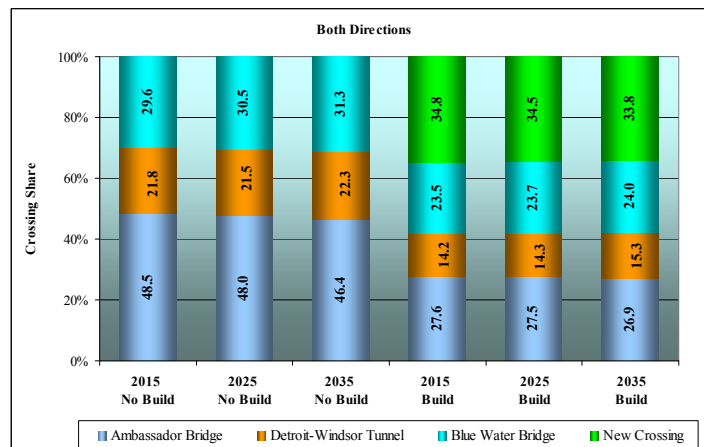

Figure 6-6. Total Crossing Share with Multinomial Logit Model

The low growth projected within Wayne County over the next 20 years in part results in very little congestion related effects that contribute significantly to changes in the existing distributions of traffic within the Detroit and Windsor regions. The DRIC will capture 33.8 percent of the overall 2035 traffic along the four frontier border crossings within the Detroit/Windsor/Port Huron/Sarnia region. The model shows that the percentage share of Ambassador Bridge and the DRIC slightly decrease from 2015 to 2035, while the share of Blue Water Bridge consistently increases. This trend applies to both the passenger car and commercial vehicle markets, however, the commercial vehicle shares indicated a smaller change as compared to the passenger car shares. The share of the Detroit-Windsor Tunnel remains almost constant for passenger cars and has a very small jump for commercial vehicles – predominately as a result of the captured local market that will continue to use this crossing. The slight increases in the Blue Water shares compared to the local Detroit-Windsor crossings, in part, are a result of the model sensitivities to the congestion that eventually build up within the Detroit-Windsor local facilities in the future, and provide a relative advantage to the Blue Water Bridge, given its relatively greater capacity to absorb growth.

The DRIC will capture 27.3 percent of the total passenger car traffic by 2035. Comparison of the passenger car crossing shares from the “no build” and “build” scenarios, indicate that the DRIC will result in an average share reduction of 12 percent at the Ambassador Bridge, a 11.5 percent reduction the Detroit-Windsor Tunnel, and a 3.7 percent reduction at the Blue Water Bridge by 2035.

The DRIC is forecasted to capture 44 percent of the overall commercial vehicle traffic, which will represent the highest commercial vehicle shares among the four crossings. The 2035 commercial vehicle shares as a result of the DRIC will yield a 31.1 percent reduction in the Ambassador Bridge commercial vehicle shares, while the Blue Water Bridge will experience a 13 percent reduction in its share.

TRAVEL TIME SAVING ANALYSIS

Travel time is an important factor for travelers’ crossing choice decisions. Several movements were identified to evaluate the travel time savings that the DRIC would likely generate compared to the other two existing Detroit River crossings. Highway 401 around Walker Road was identified as a decision point to choose any of the three crossings. On the U.S. side, with the exception of the markets that have origin/destination within Detroit downtown, most crossing traffic is expected to access/exit the crossings via I-96, I-75, M-10 or I-94. Two movements were defined along Highway 401 (location 1), I-75/Pensylvania Road (location 2), and I-96/Beech Daly Road (location 3). The delay caused by traffic signals along Huron Church Road was critical in evaluating the traffic that potentially will divert to DRIC. Comparisons are made for travel times between

Ambassador Bridge/DRIC and the intersection of E.C. Row Expressway and Huron Church (identified as a decision point for travelers at the two crossings).

The travel times, distances, and average speeds for the various crossings are summarized for three defined movements in **Figures 6-7 to 6-9**. **Figure 6-7** depicts the movement between Highway 401 and the I-75 south intersection with Pennsylvania Road through the three Detroit-Windsor crossings. The A, B and C paths represent the movement through DRIC, Ambassador Bridge, and Detroit-Windsor Tunnel, respectively. The movement through DRIC starts at Highway 401, and travels along the planned Windsor-Essex Parkway and connecting to I-75 via the direct connectors. This movement provides a freeway-to-freeway connection with a total travel distance of approximately 24 miles. Path B via Ambassador Bridge uses part of the planned Windsor-Essex Parkway and connects through a portion of the existing Huron Church Road to the bridge, and then continues onto I-75 on the U.S. side. Path C crosses the border via Detroit-Windsor Tunnel through Dougall Avenue/Ouellette Avenue on the Canadian side and then passes through Jefferson Avenue/M-10/I-75 to the

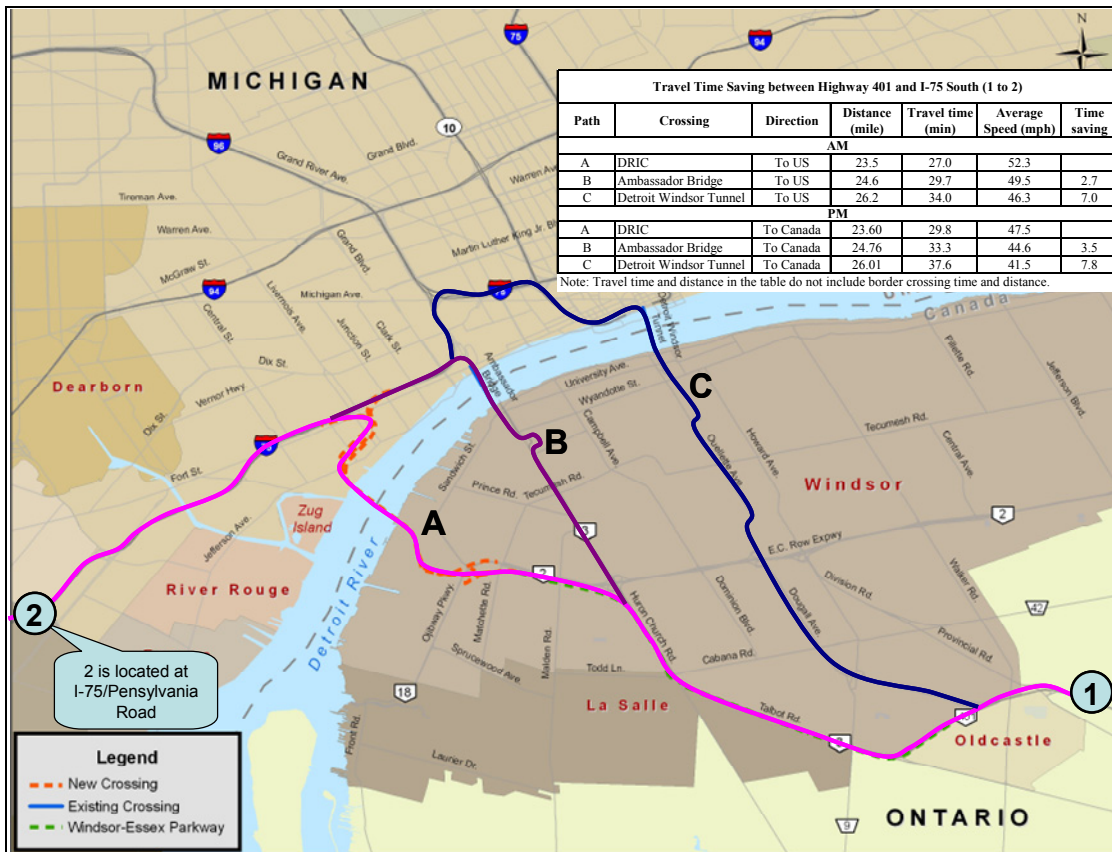

Figure 6-7. 2025 Travel Time Comparison between Highway 401 and I-75/Pennsylvania Road

Path C crosses the border via Detroit-Windsor Tunnel through Dougall Avenue/Ouellette Avenue on the Canadian side and then passes through Jefferson Avenue/M-10/I-75 to the

defined destination. Path B has the distance of approximately 25 miles, while Path C is approximately 26 miles long. The comparison of the distance indicates that Path A via DRIC is the shortest compared to Path B and Path C respectively. The travel time shown in the graphic represents year 2025 with the peak traffic direction in the a.m. peak period being in the U.S.-bound direction and the p.m. peak being in the Canada-bound direction. As shown, Path A via the DRIC has the shortest travel time and was shown to save approximately 2.7 minutes/7.0 minutes in the morning peaks, and 3.5 minutes/7.8 minutes in the afternoon peak compared to Path B and Path C, respectively.

Movement from location 1 to location 3 between Highway 401 and I-96/Beech Daly Road was also evaluated for the three paths. Under this movement, the three paths take similar routes to location 1 and location 2 movements but continue through I-96 north on the U.S. side. As shown in **Figure 6-8**, Path A via DRIC has the longest distance of approximately 26 miles and Path B via Ambassador Bridge has almost the same distance of 24 miles as Path C via Detroit-Windsor Tunnel.

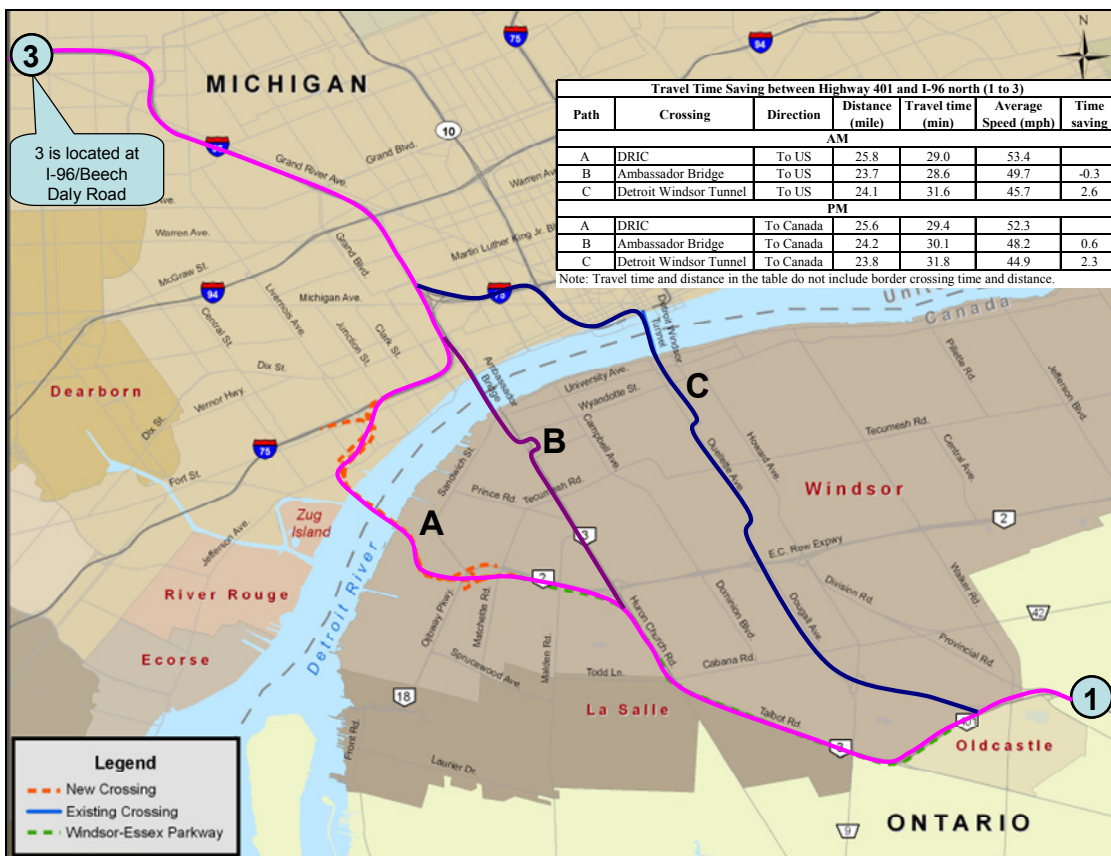

Figure 6-8. 2025 Travel Time Comparison between Highway 401 and I-96/Beech Daly Road

Although Path A has the longest distance, its travel time is almost the same as Path B in the morning peak and provides a travel time savings due to its freeway connections. Path A saves approximately 2.6 minutes/2.3 minutes comparing to Path C via Detroit-Windsor Tunnel for morning and afternoon peaks, respectively.

Review of the movement between Huron Church Road/E.C. Row Expressway and Ambassador Bridge and new proposed crossing was specifically designed to examine the differential in travel times due to the traffic signals along Huron Church Road. The movement, as shown in **Figure 6-9**, starts at the split of Windsor-Essex Parkway at Huron Church Road and includes the ramps connecting to Huron Church Road. Path A represents the movement from this split point to the entrance to the DRIC plaza on Canadian side, while Path B represents the movement to the entrance of the Ambassador Bridge Plaza on the Canadian side.

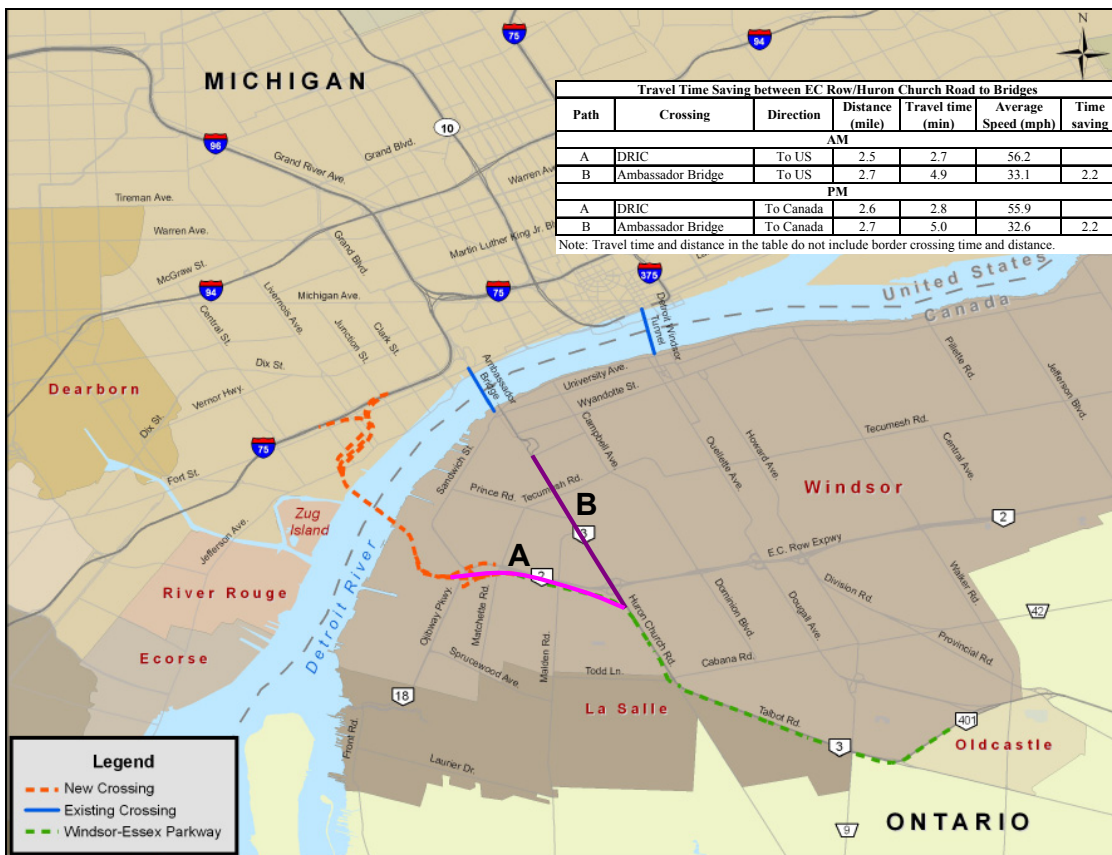

Figure 6-9. 2025 Travel Time Comparison between Huron Church Road/E.C. Row Expressway and Bridges

Both paths were shown to have almost the same distances with Path A reflecting 2.5 miles in the U.S.-bound direction (2.6 miles in the other direction) and Path B reflecting 2.7 miles. Path A is shown to take approximately 2.7 minutes as compared to 4.9 minutes

of Path B in the morning peak, which represents a travel time saving of 2.2 minutes. The afternoon peak demonstrated a similar time saving pattern.

ANNUAL TRAFFIC BASIC ASSUMPTIONS

The annual traffic estimate of the proposed DRIC was developed based on the following basic assumptions:

1. The DRIC is assumed to open to traffic in January, 2016;
2. The freeway-to-freeway connectivity of the DRIC and accessibility to the regional roadways on both sides of the bridge are as described in the report;
3. The future roadway networks include only those highway improvements identified in this report;
4. The domestic trip matrices used in this study were based on databases developed as part of the DRIC-EIS study, which included the Windsor Area Long-range Transportation Study (WALTS) on the Canadian side and the SEMCOG model on the U.S. side. The domestic trip matrices on the U.S. side were updated to reflect the demographic forecast developed by SEMCOG as part of the 2035 Regional Transportation Plan (RTP);
5. The border crossing travel times are based on the baseline assumptions discussed in Chapter 6;
6. The future frontier traffic growth is estimated based on the best knowledge of current economic conditions. It is recognized that large uncertainties exist in the near-term forecast due to the uncertain economic turmoil and given that the outlook for economic recovery within the region varies greatly among the different official sources;
7. Ramp-up is assumed to be modest at 90 percent in the first year and 95 percent in the second year, given that this bridge project has been discussed publicly for many years and is in close proximity to the existing crossings;
8. The crossing choice model was developed based on the stated-preference survey efforts conducted as part of this study and was calibrated to the revealed choices of the existing crossings;
9. Economic growth in the study corridor is based upon projections and growth patterns, as described in Chapter 4, and the independent economic review conducted and summarized in Appendix C;
10. The local network improvements within the region reflect the most recent official transportation plans that include 2035 SEMCOG RTP local projects and WALTS;

11. Motor fuel will remain in adequate supply and increases in price will not substantially exceed overall inflation over the long term; and
12. No local, regional, or national emergency will arise which would abnormally restrict the use of motor vehicles.

Any significant departure from the above basic assumptions could materially affect estimated traffic for the proposed Detroit River International Crossing.

ANNUAL TRAFFIC ESTIMATE

The 50-year annual traffic estimate of the DRIC assumes the opening year of 2016, and builds upon the comprehensive analysis and data collection efforts as outlined in the report. The traffic estimates reflect a baseline estimate, to represent the most probable forecast based on the study team's knowledge and understanding of current social, economic, and traffic conditions. It is acknowledged that the baseline values of the variables used in the modeling and other key assumptions made for the traffic estimate have inherent uncertainties, especially as a result of the volatility of many factors that include fuel prices, and the current financial crisis and economic turmoil that occurred while the study was being undertaken. Recognizing this, sensitivity analysis and risk assessment were conducted to evaluate the impact of the key assumptions and to quantify the uncertainty of the future forecasts, as described further in Chapter 7.

The baseline traffic estimate shown in **Table 6-8** was developed for the passenger car and commercial vehicle markets. The total traffic listed in **Table 6-8** includes passenger cars, commercial vehicles, and a small percentage of miscellaneous classified traffic (motorcycles etc.), which was assumed based on the historical transactions at the Ambassador Bridge. The DRIC is expected to attract approximately 3.1 million passenger cars by the opening year (2016) and approximately 2.7 million commercial vehicles. The DRIC, under the baseline assumptions, is forecasted by 2025 to capture 4.4 million and 3.9 million passenger cars and commercial vehicles, respectively, representing an average annual growth rate of 4.1 percent and 4.0 percent between 2016 and 2025. The passenger car traffic along the DRIC is expected to grow to 6.0 million by 2035 and 7.7 million by 2060, which reflects a long-term annual growth rate of approximately 1.0 percent during the 25-year period. The commercial vehicle traffic growth during the same time period is expected to grow from 4.9 million to 7.0 million, which reflects an average annual growth rate of approximately 1.5 percent.

Year	Passenger Car	Commercial Vehicle	Total*
2016	3,073	2,747	5,862
2017	3,259	2,985	6,290
2018	3,448	3,234	6,730
2019	3,466	3,327	6,842
2020	3,524	3,423	6,997
2021	3,635	3,519	7,205
2022	3,790	3,616	7,459
2023	3,975	3,716	7,746
2024	4,204	3,819	8,080
2025	4,418	3,921	8,398
2026	4,651	4,022	8,736
2027	4,868	4,122	9,054
2028	5,069	4,221	9,357
2029	5,227	4,316	9,612
2030	5,384	4,411	9,866
2031	5,529	4,505	10,106
2032	5,650	4,597	10,321
2033	5,772	4,689	10,536
2034	5,894	4,780	10,751
2035	6,000	4,870	10,948
2036	6,108	4,959	11,147
2037	6,170	5,048	11,299
2038	6,231	5,137	11,450
2039	6,291	5,225	11,599
2040	6,351	5,312	11,747
2041	6,411	5,399	11,894
2042	6,470	5,485	12,041
2043	6,529	5,570	12,186
2044	6,588	5,654	12,330
2045	6,656	5,739	12,485
2046	6,724	5,824	12,638
2047	6,792	5,908	12,791
2048	6,859	5,991	12,943
2049	6,927	6,072	13,093
2050	6,995	6,153	13,242
2051	7,063	6,232	13,391
2052	7,131	6,312	13,540
2053	7,199	6,393	13,690
2054	7,267	6,475	13,841
2055	7,335	6,558	13,993
2056	7,404	6,641	14,146
2057	7,472	6,726	14,300
2058	7,541	6,811	14,455
2059	7,609	6,898	14,612
2060	7,678	6,985	14,769
2061	7,747	7,073	14,927
2062	7,816	7,163	15,086
2063	7,885	7,253	15,247
2064	7,954	7,344	15,409
2065	8,029	7,438	15,578

* The total transactions include passenger cars, commercial vehicles and miscellaneous traffic such as motorcycles.

ANNUAL AVERAGE WEEKDAY TRANSACTIONS

The seven-days counts collected at the three existing crossings as part of this study demonstrated that weekend traffic typically has a different travel pattern from weekday traffic, as described in detail in Chapter 3. **Table 6-9** provides a summary of the 2008 detailed data¹ that was collected as part of the comprehensive study for the weekend traffic and weekday traffic for the two existing Detroit-River crossings. The passenger car crossing traffic on the Ambassador Bridge during the weekend has a strong differential between the Canada-bound (69 percent of the weekday average) and U.S.-bound (95 percent of the weekday average) traffic volumes. On the other hand, the weekend commercial traffic at the Ambassador Bridge represents a much lower percentage of weekday traffic of approximately 32 to 36 percent. The magnitude of the weekend traffic compared to the weekday traffic at the Detroit-Windsor Tunnel shows a similar directional pattern for passenger cars with higher volumes occurring for the U.S.-bound commercial vehicle traffic.

Table 6-9 Estimated Annualization Factors for the Proposed DRIC				
Facility	Passenger Car		Commercial Vehicle	
	Entering Canada	Entering U.S.	Entering Canada	Entering U.S.
Weekend Traffic as a Percentage of Weekday Traffic				
Ambassador Bridge	69%	95%	32%	36%
Detroit-Windsor Tunnel	86%	84%	45%	78%
Estimated Annualization Factors				
Ambassador Bridge	329	359	287	291
Detroit-Windsor Tunnel	349	347	302	340

The annual average weekday traffic for the DRIC was calculated for the opening year and the other three future years, as shown in **Table 6-10**. The total traffic shown in the table includes some miscellaneous traffic, in addition to the passenger car and commercial vehicle markets. The DRIC is anticipated to attract approximately 9,000 passenger car traffic and 9,500 commercial vehicle traffic during a normal weekday by the opening year of 2016. These will by 2025 grow to 12,800 and 13,500 for the passenger car and commercial vehicle, respectively. The DRIC is therefore expected to serve a total of approximately 26,500 daily vehicles by 2025, and over 37,000 by 2040 when the miscellaneous traffic is included.

¹ Note: The 2008 weekend/weekday distributions are used here since the 2009 data was captured in November/December as spot counts during representative weekdays rather for an entire week as previously undertaken in 2008.

Table 6-10			
Estimated Annual Average Weekday Transactions on the Proposed DRIC			
Year	Passenger Car	Commercial Vehicle	Total Weekday Traffic¹
2016	9,000	9,500	18,700
2025	12,800	13,500	26,500
2035	17,500	16,900	34,600
2040	18,500	18,400	37,100

Note: ¹ The total transactions of both average weekday and peak hour include passenger cars, commercial vehicles and miscellaneous traffic such as motorcycles.

CHAPTER 7

SENSITIVITY ANALYSIS AND RISK ASSESSMENT

The forecast of future traffic demand has a certain level of uncertainty associated with multiple key variables, upon which the travel demand is dependent. Traffic forecasts are typically point forecasts that are generated based on assumptions developed from reasonable historical and forecasted averages that outline the most likely base case for future scenarios. However, the level of uncertainty around these average assumptions also needs to be taken into account for purposes of evaluating the potential range under which the travel demand of the facility may fall. The level of upward or downward deviations from the mean, in concert with the likelihood of one variable occurrence over the other, is an important consideration in developing the full range of possible outcomes. While a full account of the overall risk associated with forecasting into the future is difficult to quantify, the following risk analysis undertaken as part of this study identifies some key variables whose influence and effect on the traffic demand are significant enough to warrant further analysis and description.

The following chapter describes the risk analysis undertaken for the proposed Detroit River International Crossing (DRIC) that includes individual sensitivity testing of several selected key parameters. An overall upper and lower case range of the future annual traffic demand are created from the various sensitivity analyses results to outline the potential range of future demand around the most probable estimates that were developed in Chapter 6.

RISK ASSESSMENT METHODOLOGY

The sources of uncertainty in the traffic forecasting can, in general, be classified under two categories: the modeling methodology and the forecasted model variable inputs. The modeling methodology is typically addressed by using the state-of-the-art and best practices regarding the industry accepted methodologies. These are continuously evolving as both software, hardware, and data becomes more advanced and readily available for use within the modeling/forecasting community. The four-step travel demand models and the logit choice model formulations used and applied in developing the traffic forecast of this study used standard accepted practices. The uncertainty of the forecasts caused by the methodology is, to an extent, very difficult to quantify given the balance between complexity and the time and monetary constraints that typically differ between the various methodologies that can be implemented. The models and databases used as the baseline for this study for example draws upon many years of model development from multiple agencies that included the SEMCOG, WALTS, and two consulting teams working on the environmental assessments on both sides of the border.

The model frameworks were, therefore, not analyzed quantitatively, however, they were reviewed for compliance with standard practices in their development and reasonableness checks of the inputs and forecasts were undertaken. The forecasts of the variables used in the models to some extent can generate the largest uncertainty in the future forecast of the travel demand regionally, locally, and within the proposed study corridor. In the case of this study, the key model input variables include the future operation of the DRIC, future growth of the international traffic, and the motorists' decision-making characteristics affecting crossing choice in the future.

SENSITIVITY ANALYSIS

Several key model inputs in the travel demand modeling process, including toll rates, border crossing time, corridor growth forecast, and the logit choice model, are evaluated and described in the following section. Under ideal conditions the probability distribution of each key parameter would be developed based on historical data in order to employ a comprehensive methodology (Monte Carlo Simulation) for uncertainty risk analysis. However, the absence of detailed historical distributions as a result of drastic regional changes, a lack of consistent historical disaggregate data, the correlation of the multiple variables affecting international crossing demand, and the discrete singular events that drastically affect crossing demand; required that a more traditional sensitivity analysis be conducted. The risk assessment of this study evaluated the independent variations of each parameter holding all others constant to measure their respective impacts on the traffic potential of the DRIC.

TOLL RATE POLICY/LEVELS

A toll rate sensitivity analysis was undertaken to understand the impact that toll rate changes at the other three crossings will have on the crossing share of the DRIC. A discrete assessment was implemented that varied the toll rate at each individual crossing while keeping the toll rate levels fixed at the other three to measure the toll elasticity and gauge the magnitude and threshold of the discretionary and captured markets for each crossing. In most cases the toll rates were varied from the toll-free condition to \$10 for passenger cars and \$50 for commercial vehicles. A total of 11 scenarios were run for each crossing, as shown in **Table 7-1**.

Table 7-1 Toll Rate Sensitivity Test Scenarios		
Scenario	Passenger Car	Commercial Vehicle
1	\$0.00	\$0.00
2	\$1.00	\$5.00
3	\$2.00	\$10.00
4	\$3.00	\$15.00
5	\$4.00	\$20.00
6	\$5.00	\$25.00
7	\$6.00	\$30.00
8	\$7.00	\$35.00
9	\$8.00	\$40.00
10	\$9.00	\$45.00
11	\$10.00	\$50.00

The toll rate analysis was conducted in 2025 and the results are assumed to be transferable to the other model years. The travel demand model was run for each of the scenarios for the three existing crossings and assumed that all other modeling variables remained at baseline levels. The crossing shares of the various toll rate scenarios that resulted from this analysis are depicted in **Figures 7-1 to 7-4** for each of the respective crossings. **Figure 7-1** indicates that the DRIC will attract as much as 70 percent of the frontier traffic of passenger cars under the toll-free condition, with toll rates at the other existing crossings remaining the same as assumed for 2025. This share is shown to reduce to approximately 5 percent once the passenger car toll rate levels on the DRIC exceed \$10. The analysis also showed that the Blue Water Bridge share of passenger car only deviates by approximately 6 percent between the toll-free and high toll rate levels at the DRIC, while the DRIC share deviated by over 65 percent, with most of the traffic diverting to Ambassador Bridge and Detroit-Windsor Tunnel. The commercial vehicle shares along DRIC crossing ranged from 64 percent to 25 percent under the toll-free condition and high toll rate scenario, as shown in **Figure 7-1**. The commercial vehicle

analysis also confirmed that the Blue Water Bridge variation in captured shares, only deviated by approximately 8 percent between the two extreme toll rate levels while the Detroit-Windsor Tunnel showed marginal gains in crossing shares with the majority of commercial traffic diverting to Ambassador Bridge.

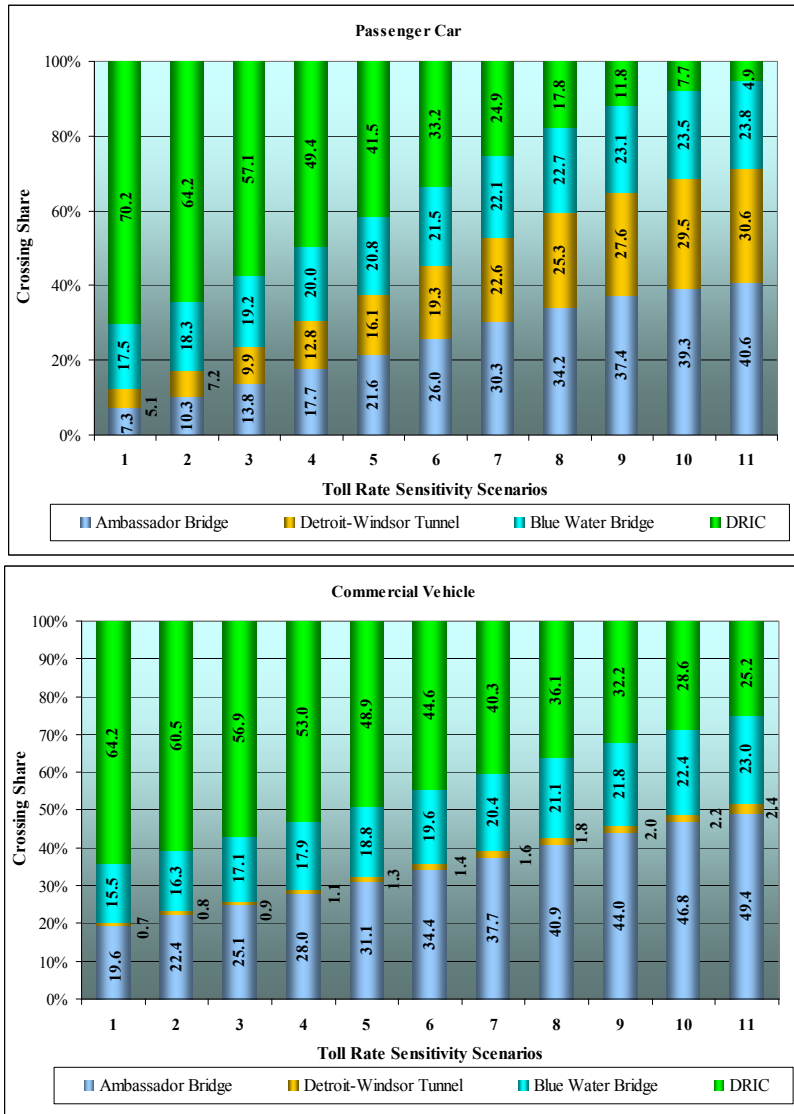

Figure 7-1. Crossing Shares - DRIC Toll Rate Sensitivity

The crossing share results from the toll rate sensitivity tests on Ambassador Bridge are presented in **Figure 7-2**. The passenger car share of Ambassador Bridge was shown to vary between 69 percent and 4 percent under the toll-free condition, and the high toll rate level respectively, with the majority of the diverted traffic going to the DRIC and Detroit-Windsor Tunnel. The commercial vehicle share of Ambassador Bridge varied between 55 percent and approximately 17 percent, with the shares of the Tunnel remain almost constant with very marginal increases. The majority of the diverted traffic is shown to go to the DRIC as toll rates are increased with the Blue Water Bridge only shown to gain approximately 7 percent more.

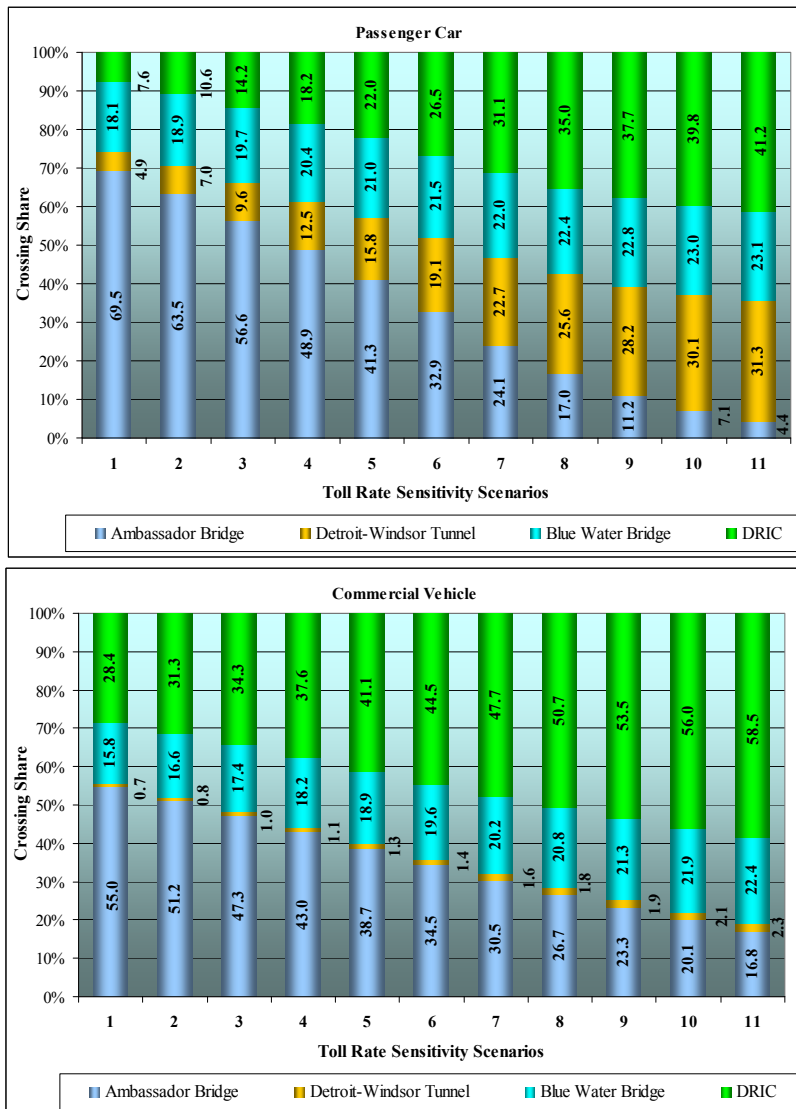

Figure 7-2. Crossing Shares - Ambassador Bridge Toll Rate Sensitivity

The sensitivity tests results of the Detroit-Windsor Tunnel, as shown in **Figure 7-3**, illustrates that under the toll-free scenario, the Detroit-Windsor Tunnel would capture approximately 63 percent of the overall passenger traffic and the majority of passenger car traffic under the higher toll rates scenarios will divert almost equally to the other two Detroit River crossings (DRIC and Ambassador Bridge). The change of commercial vehicle toll rates at the Detroit-Windsor Tunnel did not have much impact on the distribution of commercial traffic among the four crossings, given the commercial vehicle restrictions in place that limits the overall volume of traffic that can use this crossing.

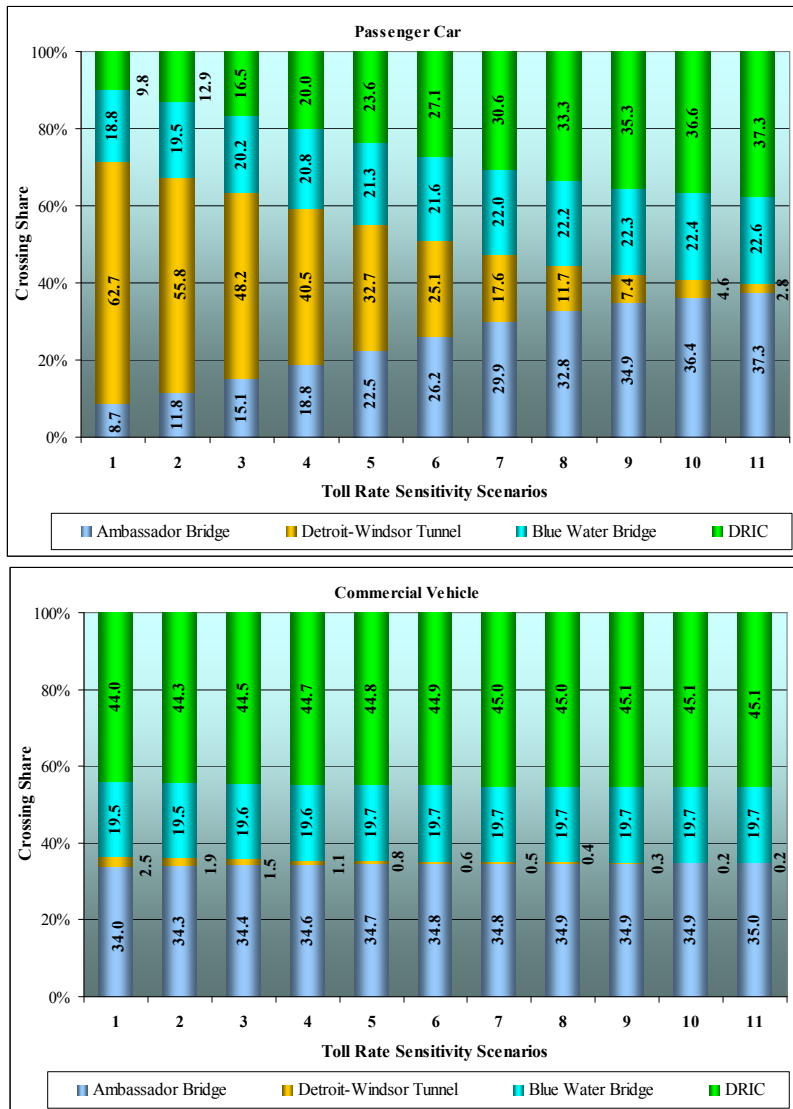

Figure 7-3. Crossing Shares - Detroit-Windsor Tunnel Toll Rate Sensitivity

The sensitivity toll rate analysis results of Blue Water Bridge, as shown in **Figure 7-4**, revealed that the passenger car crossing share of the Blue Water Bridge reduced from 31 percent under the toll-free condition to approximately 16 percent under the high toll rate charge. This variation in the overall percentage of passenger vehicles captured was much smaller than at the three Detroit crossings and illustrates magnitude of the captured market that the bridge serves (i.e. approximately 15 percent of the overall border crossing passenger market is long distance related).

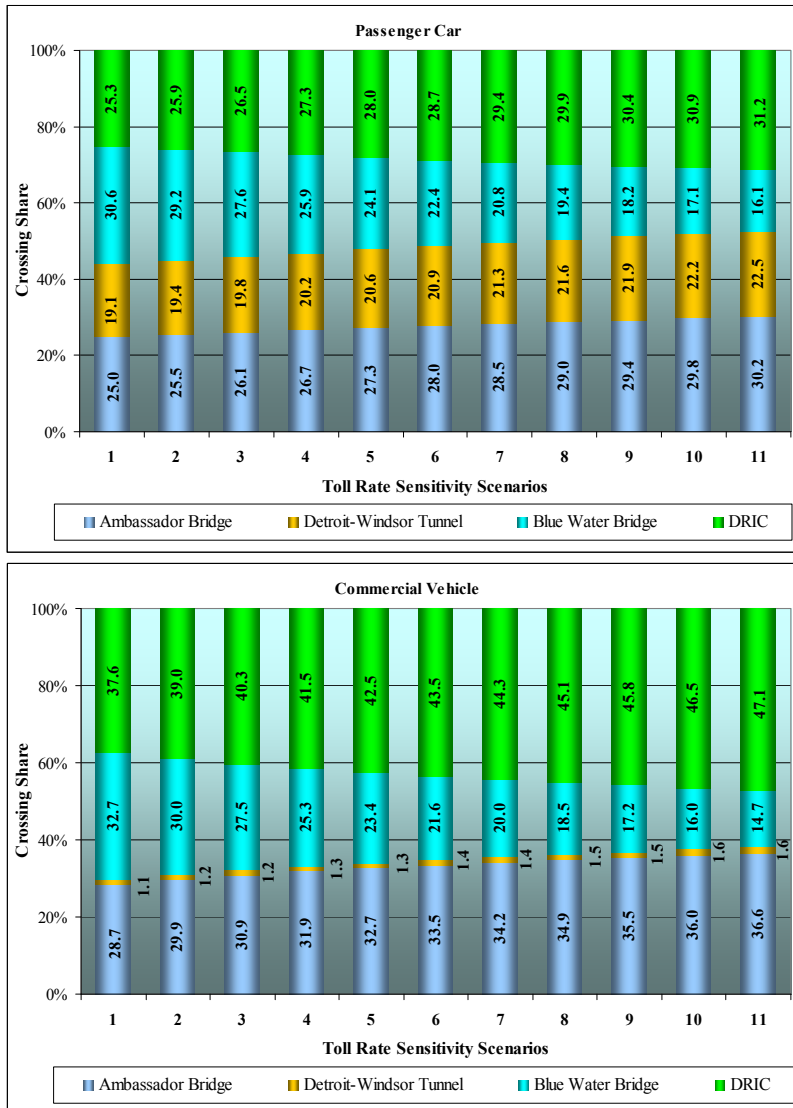

Figure 7-4. Crossing Shares - Blue Water Bridge Toll Rate Sensitivity

The DRIC and Ambassador Bridge were shown to attract most of the passenger vehicles diverted from Blue Water Bridge. The commercial vehicle crossing share of Blue Water

Bridge varied between approximately 33 percent to around 15 percent under the toll-free condition and high toll rate level scenario, respectively. The DRIC was shown to capture approximately 60 percent of the total diverted traffic from Blue Water Bridge, while the remaining 40 percent was diverted to the Ambassador Bridge.

The toll rate sensitivity analysis and results for the crossings indicated that the three Detroit-River crossings have strong competition against each other for passenger vehicle market. The captured crossing traffic shares were shown to be very sensitive to toll rate adjustments at the other crossings, which confirm historical trends observed from several past toll rate adjustments at the existing crossings. The Blue Water Bridge was shown to have a captive local market that is less affected by toll rate adjustments at the Detroit-River crossings, however, the long-distance markets are forecasted to continue to grow in the future, such that the influence and effects are also likely to increase. The DRIC was shown to maintain a competitive advantage for the commercial vehicle traffic over Ambassador Bridge, given its direct freeway-to-freeway connectivity.

Figure 7-5 shows the magnitude of the impact that the toll rate sensitivities at the three existing crossings will have on the projected transactions of the DRIC. The transactions of the DRIC were indexed to the base case for each of the tested scenarios taking into consideration the toll rate sensitivities, including those developed as part of the baseline, as shown in Chapter 6. The analysis showed that toll rate changes at the Ambassador Bridge would have the most significant impact on the DRIC for both passenger car and commercial vehicle traffic, while drastic toll rate adjustments at the Detroit-Windsor Tunnel would affect the passenger car traffic but have only marginal impacts to the commercial vehicle demand at the DRIC. The Blue Water Bridge toll rate changes were shown to have a moderate impact on the future transaction at the DRIC for both passenger cars and commercial vehicles.

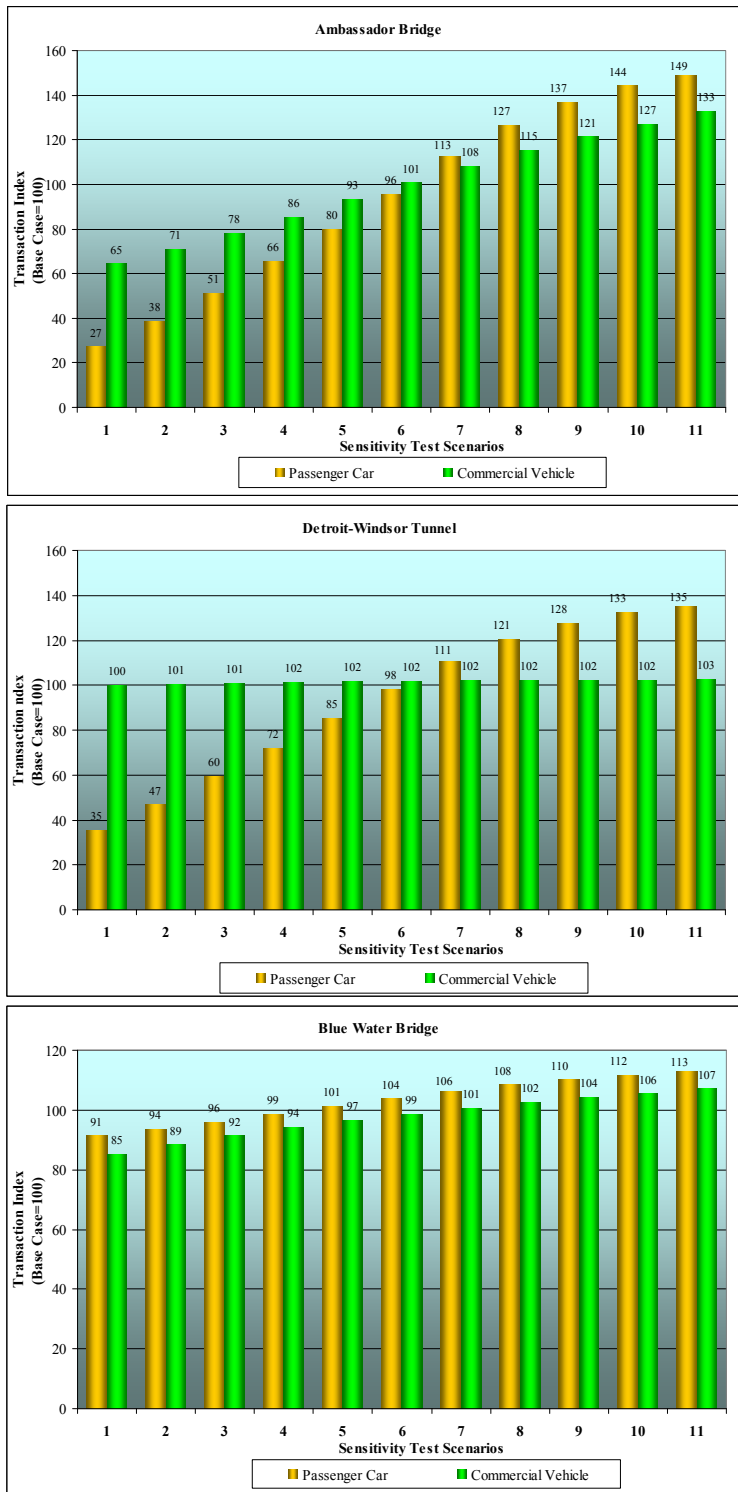

Figure 7-5. Traffic Index of the DRIC from Toll Rate Sensitivity Tests

BORDER CROSSING TIME

Border crossing travel time is an important factor that affects the crossing choice of the motorists as discussed previously in Chapter 6. The average crossing time and respective ranges at the three existing crossings were developed based on collected and historical field data. For purposes of the baseline forecast the crossing time delay at the DRIC was assumed to be similar to the existing Ambassador Bridge. The current crossing times, however, have the potential to be improved through the provision of sufficient processing capacity, simplification of the inspection/immigration process with programs such as the NEXUS, or by adding nonstop toll payment systems such as electronic tolling or video payment options. The reverse is of course true if the immigration policies such as Western Hemisphere Travel Initiatives make the border processing times more stringent and cumbersome to the travelers. In order to evaluate the impact of the border crossing time on the crossing choice and future traffic estimates, sensitivity analyses were conducted on each of the crossings by varying the crossing time at each crossing independently, while maintaining the baseline crossing time assumptions at the other crossings.

Table 7-2 shows the eight (8) scenarios of crossing time test scenarios. The crossing time varies from 5 minutes to 19 minutes for passenger cars. The crossing time of 5 minutes is considered the shortest time with minimum delay. The range of commercial vehicle crossing time tested is from 5 minutes to 40 minutes. These border crossing times represents the minimum starting values. The crossing time during the assignment were updated through each iteration based on the relationship of crossing time and traffic demand established using the field border crossing time measurement and traffic counts.

Scenario	Passenger Car	Commercial Vehicle
1	5.0	5.0
2	7.0	10.0
3	9.0	15.0
4	11.0	20.0
5	13.0	25.0
6	15.0	30.0
7	17.0	35.0
8	19.0	40.0

The crossing shares from the sensitivity tests are presented in **Figures 7-6 to 7-9** for both passenger cars and commercial vehicles. **Figure 7-6** shows the variation of the crossing shares as the crossing times are varied at the DRIC. The DRIC share of passenger car

traffic decreased from 32 percent to around 14 percent, as the crossing time varied between 5 minutes and 19 minutes. The results showed that the majority of the traffic diverted equally to the two existing Detroit-River crossings, while the Blue Water Bridge only received marginal gains. The commercial vehicle crossing shares on the other hand were shown to decrease from around 58 percent to 19 percent when the crossing times were increased from 5 minutes to 40 minutes. The majority of the commercial vehicle traffic diverted to Ambassador Bridge, as expected, with Blue Water Bridge only capturing approximately 25 percent of the overall diverted traffic.

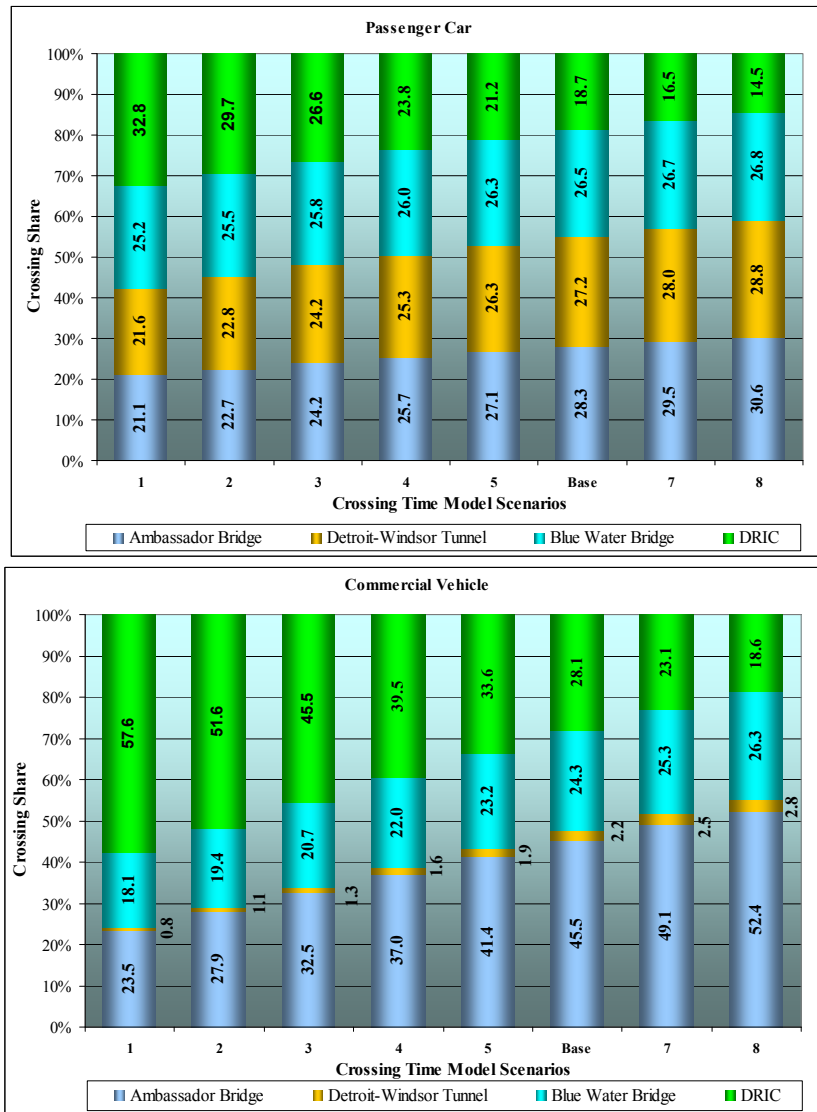

Figure 7-6. Crossing Shares - DRIC Border Crossing Time Sensitivity

Figure 7-7 depicts the crossing shares of the sensitivity tests on Ambassador Bridge and illustrates that the passenger car crossing share of Ambassador Bridge decreased from approximately 27 percent to 10 percent as the crossing time was increased from 5 minutes to 19 minutes. Over 50 percent of the passenger vehicle traffic diverted to DRIC crossing while 40 percent diverted to the Detroit-Windsor Tunnel and the remaining 10 percent to the Blue Water Bridge. The majority of the commercial vehicles were shown to divert to the DRIC as the Ambassador Bridge border crossing times were increased from the 5 minutes to 40 minutes.

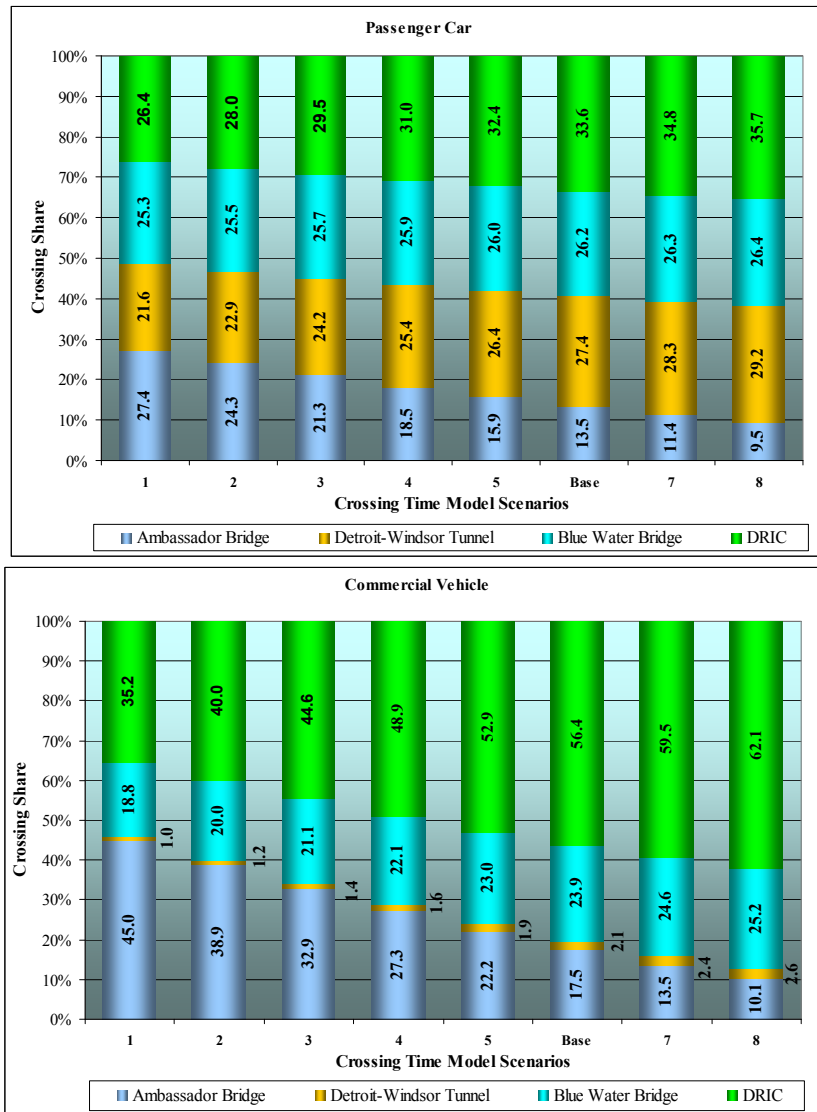

Figure 7-7. Crossing Shares - Ambassador Bridge Border Crossing Time Sensitivity

The crossing shares from the border crossing sensitivity tests at Detroit-Windsor Tunnel are shown in **Figure 7-8**. The Detroit-Windsor Tunnel's share of passenger car traffic decreased from approximately 25 percent to 12 percent as the border crossing times were increased from 5 minutes to 19 minutes. The majority of the traffic diverted evenly to the DRIC crossing and Ambassador Bridge with very little diversion occurring to the Blue Water Bridge. The variation of border crossing times at the Detroit-Windsor Tunnel showed no significant impacts to the commercial vehicle traffic shares at the other crossings.

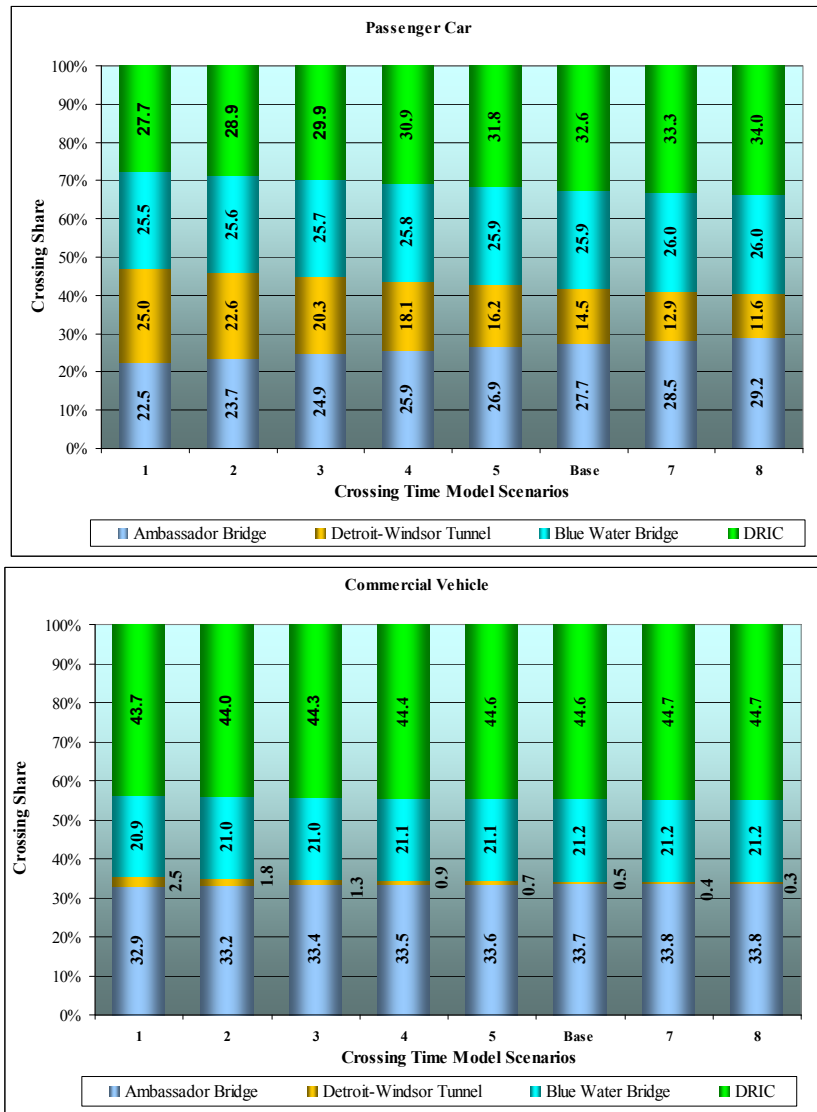

Figure 7-8. Crossing Shares - Detroit-Windsor Tunnel Border Crossing Time Sensitivity

Figure 7-9 illustrates the crossing shares of the border crossing time sensitivity analysis performed at Blue Water Bridge which showed a much smaller variation occurring on both its passenger car and commercial vehicle shares. In most cases that variation appears to be very marginal and again outlined the captive markets currently being serviced by the Blue Water Bridge that are a smaller share of the overall border crossing markets. The majority of the diverted long-distance traffic is shown to shift to the DRIC and the Ambassador Bridge.

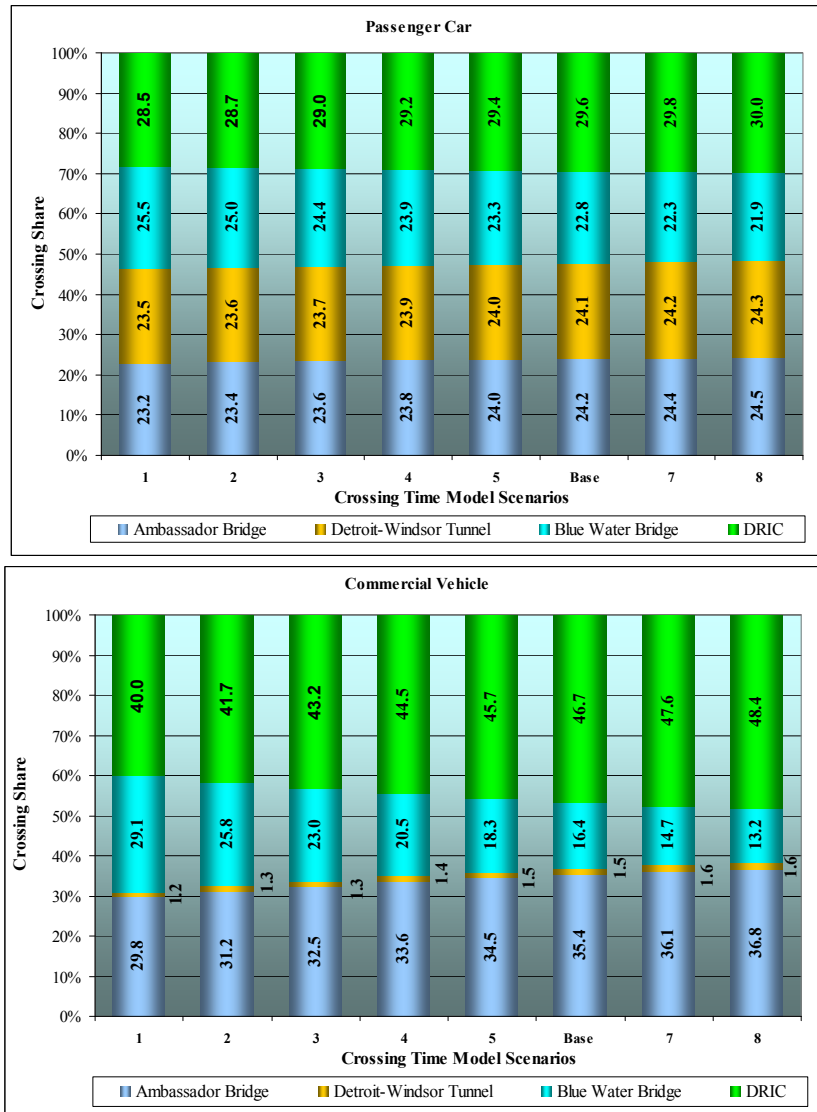

Figure 7-9. Crossing Shares - Blue Water Bridge of Border Crossing Time Sensitivity

Figure 7-10 shows the index of the traffic estimate of the test scenarios relative to the baseline traffic demand, assuming that all other baseline assumptions were kept fixed. The border crossing time sensitivity analysis results indicate that the crossing times at the DRIC and the Ambassador Bridge has the most significant impact on its future traffic potential, while the Detroit-Windsor Tunnel has some influence on passenger traffic. The Blue Water Bridge crossing times demonstrated a marginal impact on the DRIC.

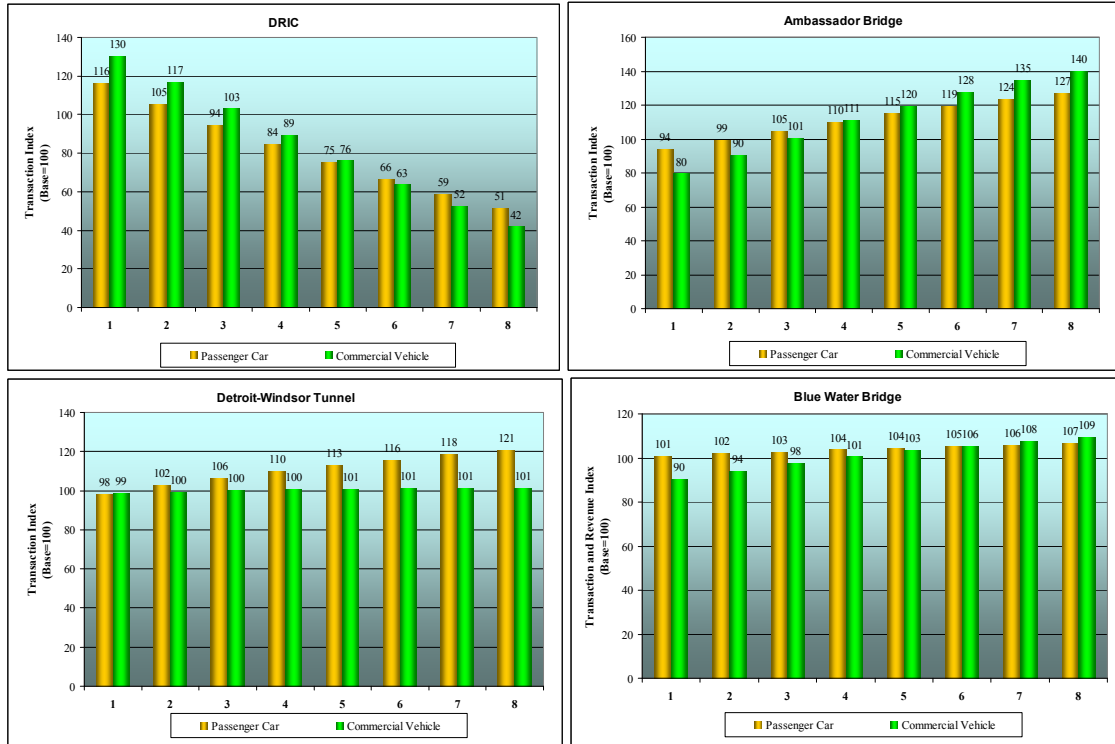

Figure 7-10. Traffic Index of the DRIC from Border Crossing Time Sensitivity Tests

CROSSING CHOICE MODEL

While the multinomial logit model was selected for the final traffic forecast of the DRIC as discussed in Chapter 6, additional analysis was performed to evaluate the logit formulation as part of the risk assessment for model structure. The risk assessment of the crossing choice model outlined in this section consisted of three key elements, namely model sensitivity analysis, crossing share forecast comparison between the multinomial logit model and nested logit model, and future crossing share forecast evaluation.

Model Sensitivity Analysis

The crossing choice models developed for this study were based on the stated preference survey efforts undertaken in April 2008, and were calibrated against the traffic counts

collected from the existing crossings in 2009. The choice models developed included an alternative specific constant and two key variables; namely travel time and toll cost. The coefficients of the two key variables represent the motorists' willingness-to-pay while the alternative specific constant reflected all the other behavioral preferences of motorists that are not explained within the time and cost variables. These additional behavioral preferences include elements such as the ancillary services of the crossing, availability of duty free stores, reliability of the crossing time, motorists' loyalty, convenience of the access roads, and many more. The developed models were tested under numerous configurations to measure the respective influence that each parameter potentially had on the alternative specific constant. This assessment helped in determining the final constants and choice models that were then used to forecast the baseline traffic estimates.

The impact of the crossing choice model on the traffic forecast was tested by modifying the constant of the DRIC while keeping the constants of the other crossings unchanged to mimic the possibility of modified traveler preferences and biases in the future. **Table 7-3** shows the eight (8) scenarios of the sensitivity tests ranging from -1.0 to 0.4 for passenger cars and from -1.5 to 0.6 for commercial vehicles, from the DRIC constant of the baseline case value of 0 (the ranges developed were based on the extensive sensitivity analysis during the stated preference survey model development process as described in Appendix B and the calibration and validation of crossing choice model, as described in Chapter 5).

Scenario	Passenger Car				Commercial Vehicle			
	DRIC	AMB	DWT	BWB	DRIC	AMB	DWT	BWB
1	-1.00	-0.145	-0.575	-0.426	-1.50	-0.210	-4.364	-1.196
2	-0.80	-0.145	-0.575	-0.426	-1.20	-0.210	-4.364	-1.196
3	-0.60	-0.145	-0.575	-0.426	-0.90	-0.210	-4.364	-1.196
4	-0.40	-0.145	-0.575	-0.426	-0.60	-0.210	-4.364	-1.196
5	-0.20	-0.145	-0.575	-0.426	-0.30	-0.210	-4.364	-1.196
Base Case	0.00	-0.145	-0.575	-0.426	0.00	-0.210	-4.364	-1.196
7	0.20	-0.145	-0.575	-0.426	0.30	-0.210	-4.364	-1.196
8	0.40	-0.145	-0.575	-0.426	0.60	-0.210	-4.364	-1.196

Note: 1. DRIC - Detroit River International Crossing; AMB - Ambassador Bridge; DWT - Detroit-Windsor Tunnel; BWB - Blue Water Bridge

2. The logit model constants of the three existing crossings shown in the above table are the average of both directions.

Figure 7-11 illustrates the crossing share results of the crossing choice sensitivity tests for passenger car and commercial vehicle markets, and shows the passenger car share of the DRIC ranged between 15 percent and 35 percent, compared to the base case scenario of 28 percent. Most of the diverted traffic came from the Ambassador Bridge and Detroit-

Windsor Tunnel while the Blue Water Bridge lost only 2 percent between the two extreme cases. The crossing shares of commercial vehicles also show significant changes varying from 24 percent to around 53 Percent around a base case scenario of 44 percent.

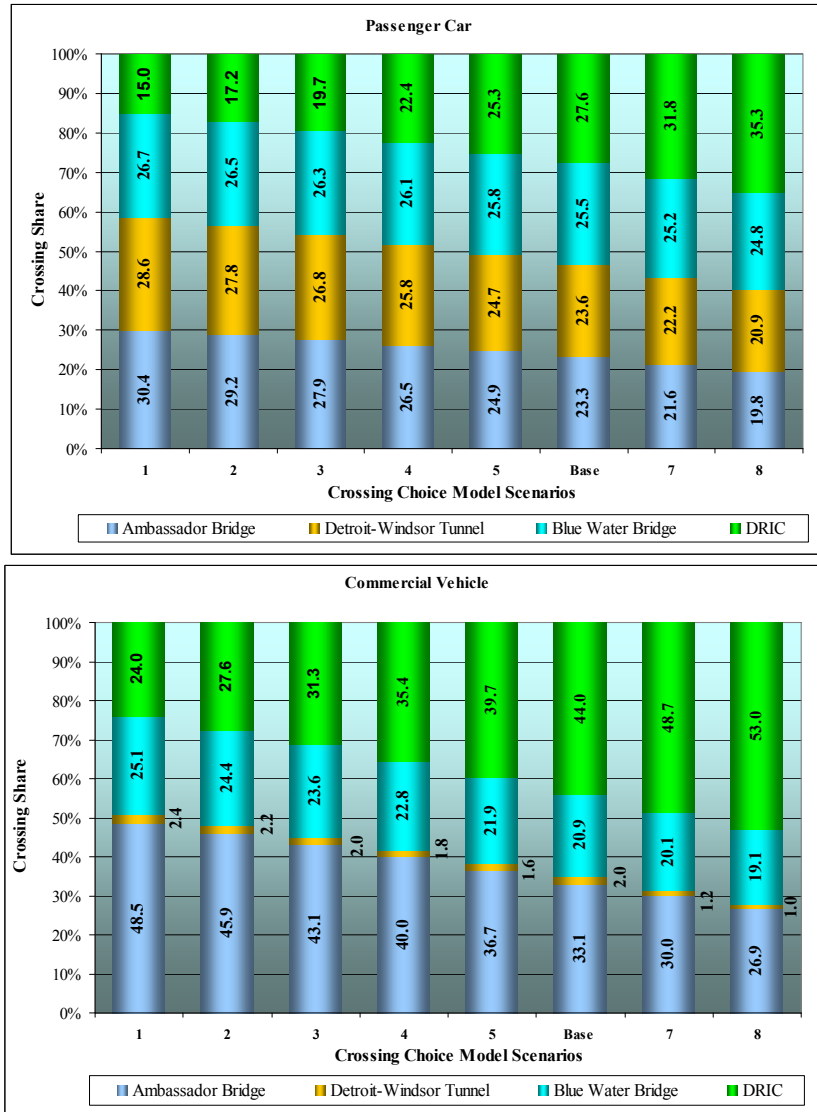

Figure 7-11. Crossing Shares of Crossing Choice Model Sensitivity Tests

The traffic index relative to the base case is shown in **Figure 7-12** and illustrates that the passenger car index increased from 54 to 128, and reflected a 2.4 times increase between the two extreme cases when the constant changes from -1.0 to 0.4 (note the toll rates are assumed to remain constant such that the transaction index trends). The commercial vehicle index also demonstrated a significant change that increased from 55 to 120 when the DRIC constant was modified from -1.5 to 0.6.

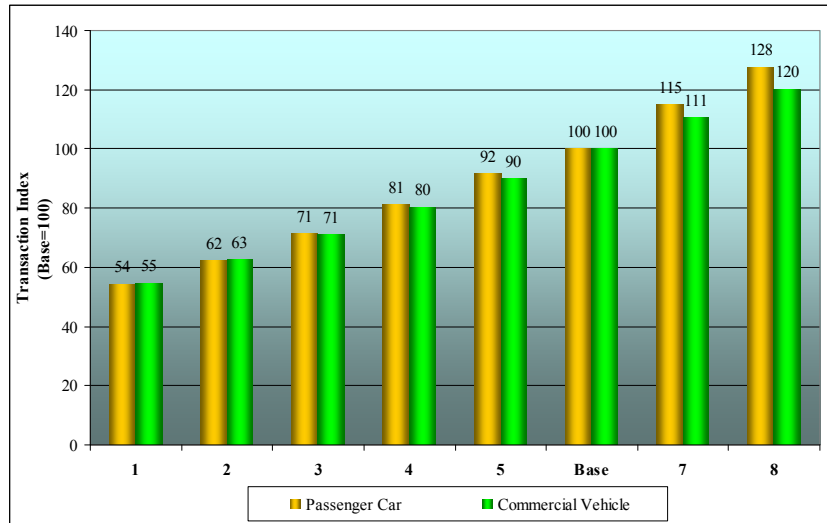

Figure 7-12. Traffic Index of the DRIC from Crossing Choice Model Sensitivity Tests

Nested Logit Model Comparison

The sensitivity analyses of the crossing choice model results helped to understand the impact of the multinomial logit model constants that was developed and calibrated. Additional checks were made to evaluate the reasonableness of the forecast results by comparing the forecast results between multinomial logit model and nested logit model, and comparing these with the traffic assignment results under a direct user equilibrium model run. **Table 7-4** shows the comparison of the crossing share model results between the multinomial and nested logit models for both passenger cars and commercial vehicles under the “build” scenario.

The crossing shares for the three modeling years were similar given the limited changes to the underlying parameters, such that only 2025 results are presented for comparison. The two models produced very similar results for all cases with the maximum difference in shares varying by 2.0 percent. The nested logit model produced slightly higher crossing shares of passenger cars for the DRIC, while the truck shares of the DRIC were almost identical. The multinomial logit model on the other hand generated slightly higher shares for the Ambassador Bridge, the majority of which were diverted from the Blue Water Bridge. The analysis of the two models led the team to determine that the multinomial logit model was the preferred model of choice based on the slightly better calibration results and performance with the sensitivity tests.

Crossings	Passenger Car			Commercial Vehicle		
	Multinomial Logit Model	Nested Logit Model	Delta	Multinomial Logit Model	Nested Logit Model	Delta
To US						
AMB	25.1%	24.2%	-0.9%	35.0%	33.0%	-2.0%
DWT	21.9%	21.2%	-0.7%	1.2%	1.2%	0.0%
BWB	26.0%	26.0%	0.0%	18.5%	20.1%	1.6%
DRIC	27.0%	28.6%	1.6%	45.2%	45.6%	0.4%
To Canada						
AMB	24.8%	24.0%	-0.8%	29.6%	27.6%	-1.9%
DWT	23.3%	22.8%	-0.5%	1.8%	1.8%	0.0%
BWB	27.3%	27.3%	0.0%	26.5%	28.6%	2.0%
DRIC	24.5%	25.8%	1.3%	42.1%	42.0%	-0.1%
Both Directions						
AMB	25.0%	24.1%	-0.8%	32.3%	30.3%	-1.9%
DWT	22.6%	22.0%	-0.6%	1.5%	1.5%	0.0%
BWB	26.7%	26.7%	0.0%	22.5%	24.3%	1.8%
DRIC	25.8%	27.2%	1.4%	43.7%	43.8%	0.1%

Note: AMB-Ambassador Bridge; DWT-Detroit-Windsor Tunnel; BWB-Blue Water Bridge; DRIC-Detroit River International Crossing

CORRIDOR GROWTH

In addition to the baseline forecast of the future frontier traffic growth, an upper case and a lower case were also developed as part of the corridor growth analysis, as described in Chapter 4 and Appendix C. This section describes the traffic estimates of the DRIC under the upper and lower case growth forecast developed as part of the corridor growth assessment. The upper and lower cases were developed specifically for the frontier traffic growth, such that all other assumptions are kept at the baseline levels as described in Chapter 6.

Figure 7-13 shows the traffic projection of the DRIC under the three corridor growth assumption cases. The low case has the minimum increase of traffic, while the high case assumes high growth trends throughout the forecast period. The average growth rate of passenger car traffic is approximately 1.7 percent during the 50-year forecast period under the low growth scenario case, while the high growth scenario forecasts a 2.0 percent average annual growth rate compared to the baseline scenario that assumed a growth rate of 1.8 percent (note that the lower growth rate in the high case is attributed to the higher starting point in the high case and the future capacity constraints that limits the growth in the future years). Commercial vehicle traffic is forecasted to grow at a slightly

higher rate than passenger cars for all the three scenarios, with 1.3 percent, 1.9 percent and 2.4 percent average annual growth for low, base and high cases, respectively.

Passenger Car

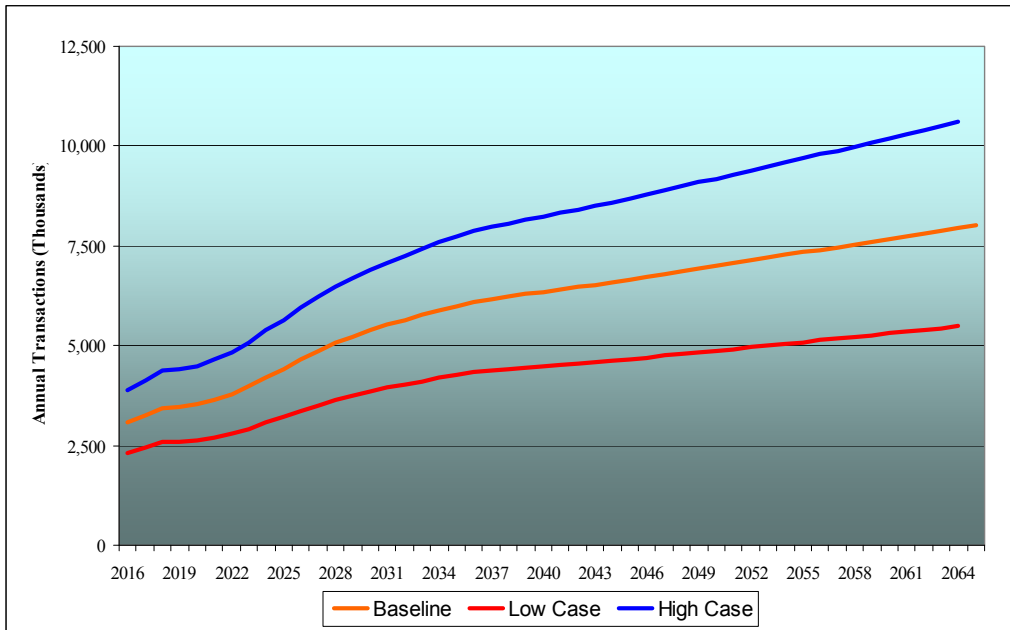

Commercial Vehicle

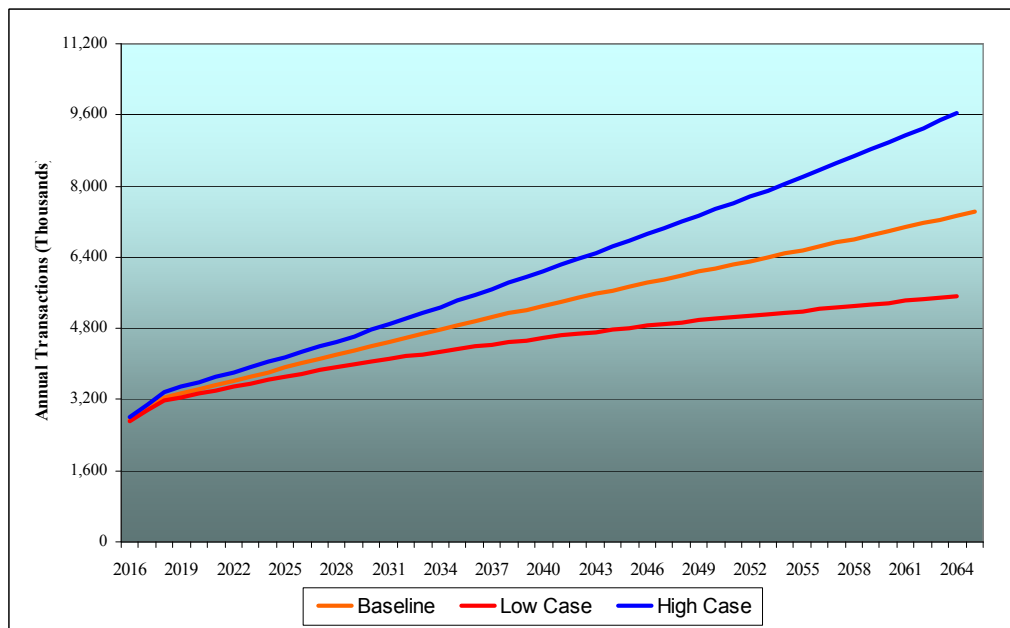

Figure 7-13. Traffic Projection - Corridor Growth Assumptions